



Product Summary

$V_{(BR)DSS}$	$R_{DS(on)TYP}$	I_D
19V	17.0mΩ@4.5V	5A
	17.5mΩ@4.0V	
	18.0mΩ@3.8V	
	19.5mΩ@3.1V	
	22.0mΩ@2.5V	

Feature

- TrenchFET Power MOSFET
- Excellent $R_{DS(on)}$
- Low Gate Charge
- High Power and Current Handling Capability
- Surface Mount Package

Application

- Battery Protection
- Load Switch
- Power Management

MARKING:

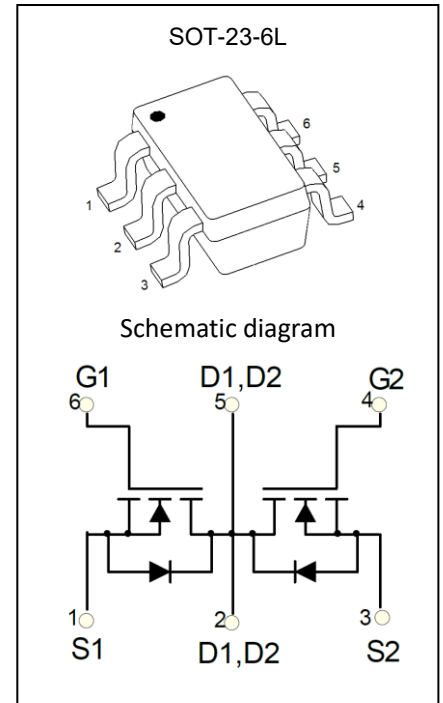
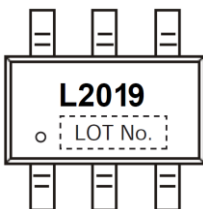

ABSOLUTE MAXIMUM RATINGS ($T_a=25^\circ\text{C}$ unless otherwise noted)

Parameter	Symbol	Value	Unit
Drain-Source Voltage	V_{DS}	19	V
Gate-Source Voltage	V_{GS}	± 10	V
Continuous Drain Current	I_D	5	A
Pulsed Drain Current ¹	I_{DM}	25	A
Power Dissipation	P_D	1.5	W
Thermal Resistance from Junction to Ambient ²	$R_{\theta JA}$	83.3	$^\circ\text{C/W}$
Junction Temperature	T_J	150	$^\circ\text{C}$
Storage Temperature	T_{STG}	-55~ +150	$^\circ\text{C}$

MOSFET ELECTRICAL CHARACTERISTICS(T_a=25°C unless otherwise noted)

Parameter	Symbol	Test Condition	Min	Type	Max	Unit
Static Characteristics						
Drain-source breakdown voltage	V _{(BR)DSS}	V _{GS} = 0V, I _D =250μA	19	20		V
Zero gate voltage drain current	I _{DSS}	V _{DS} =16V, V _{GS} = 0V			1	μA
Gate-body leakage current	I _{GSS}	V _{GS} =±10V, V _{DS} = 0V			±100	nA
Gate threshold voltage ³	V _{GS(th)}	V _{DS} =V _{GS} , I _D =250μA	0.5	0.7	1.2	V
Drain-source on-resistance ³	R _{DS(on)}	V _{GS} =4.5V, I _D =3A		17.0	23.0	mΩ
		V _{GS} =4.0V, I _D =3A		17.5	24.0	
		V _{GS} =3.8V, I _D =3A		18.0	25.0	
		V _{GS} =3.1V, I _D =3A		19.5	28.0	
		V _{GS} =2.5V, I _D =3A		22.0	32.0	
Forward Transconductance ³	g _{fs}	V _{DS} =5V , I _D =4.5A	9	11		S
Diode Forward Voltage	V _{SD}	V _{GS} =0V , I _S =1.25A		0.78	1.2	V
Dynamic characteristics⁴						
Input Capacitance	C _{iss}	V _{DS} =8V, V _{GS} =0V, f =1MHz		810		pF
Output Capacitance	C _{oss}			160		
Reverse Transfer Capacitance	C _{rss}			130		
Switching Characteristics⁴						
Total Gate Charge	Q _g	V _{DS} =10V , V _{GS} =4.5V , I _D =4A		12		nC
Gate-Source Charge	Q _{gs}			2.5		
Gate-Drain Charge	Q _{gd}			2.6		
Turn-on delay time	t _{d(on)}	V _{DD} =10V , V _{GS} =4V , I _D =1A R _G =10Ω		19		ns
Turn-on rise time	t _r			6		
Turn-off delay time	t _{d(off)}			45		
Turn-off fall time	t _f			21		

Note :

- 1.Repetitive rating: Pluse width limited by maximum junction temperature
- 2.Surface mounted on FR4 board using 1 square inch pad size,1oz single-side copper.
- 3.Pulse test : Pulse width≤300μs, duty cycle≤2%.
- 4.Guaranteed by design, not subject to production.

Typical Electrical and Thermal Characteristics

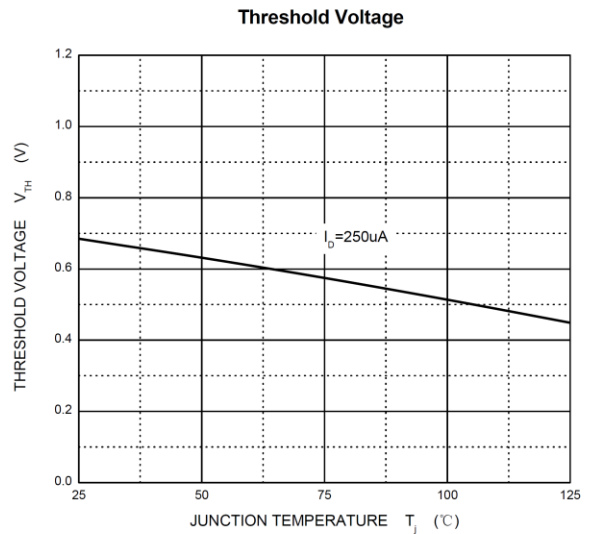
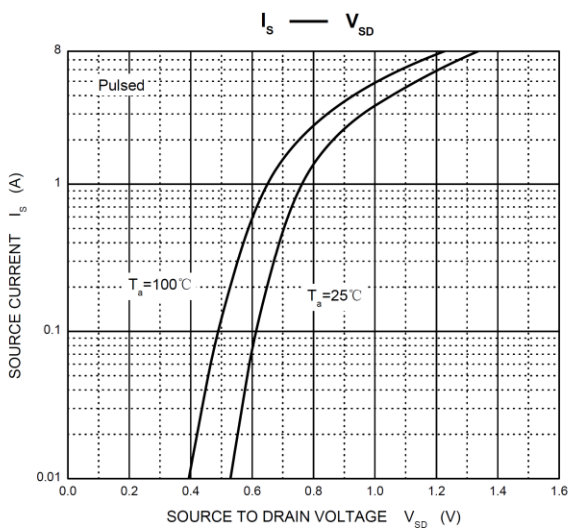
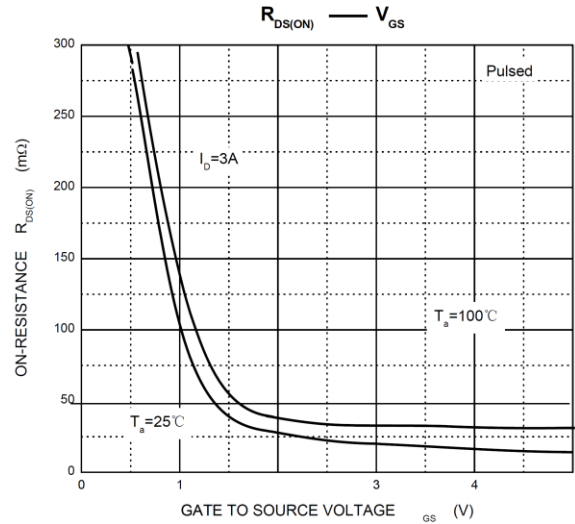
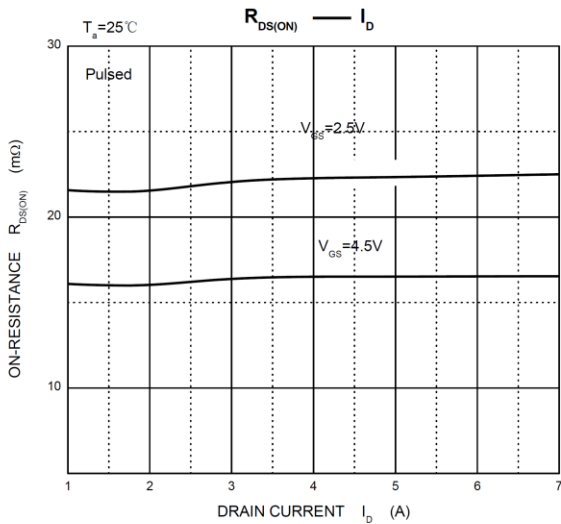
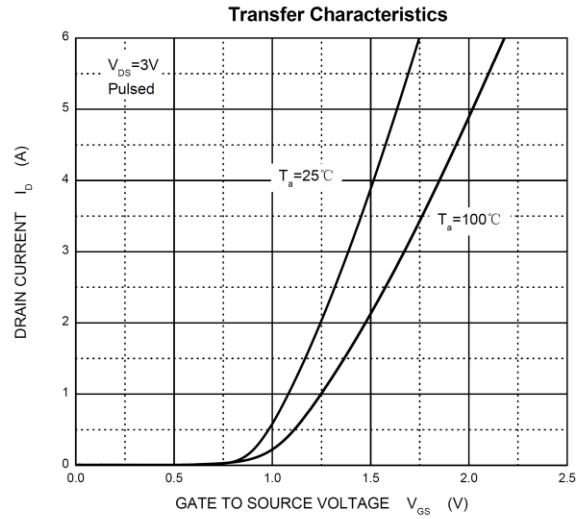
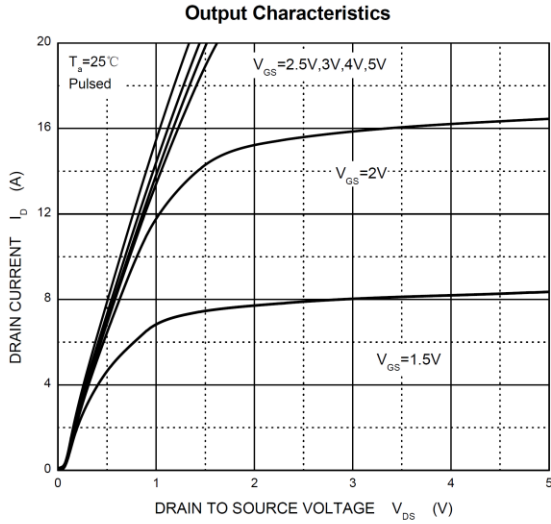

SOT-23-6L Package Information

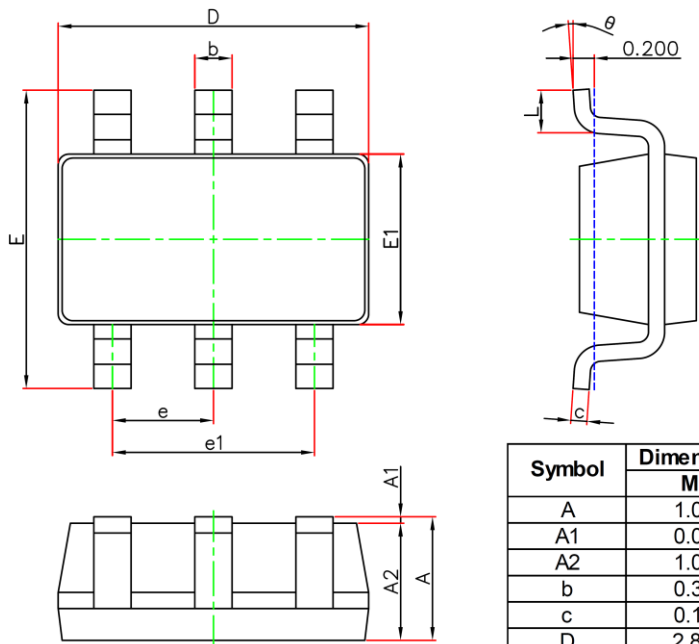

Symbol	Dimensions In Millimeters		Dimensions In Inches	
	Min.	Max.	Min.	Max.
A	1.050	1.250	0.041	0.049
A1	0.000	0.100	0.000	0.004
A2	1.050	1.150	0.041	0.045
b	0.300	0.500	0.012	0.020
c	0.100	0.200	0.004	0.008
D	2.820	3.020	0.111	0.119
E1	1.500	1.700	0.059	0.067
E	2.650	2.950	0.104	0.116
e	0.950(BSC)		0.037(BSC)	
e1	1.800	2.000	0.071	0.079
L	0.300	0.600	0.012	0.024
θ	0°	8°	0°	8°

SOT-23-6L Tape and Reel

SOT-23-6L Embossed Carrier Tape

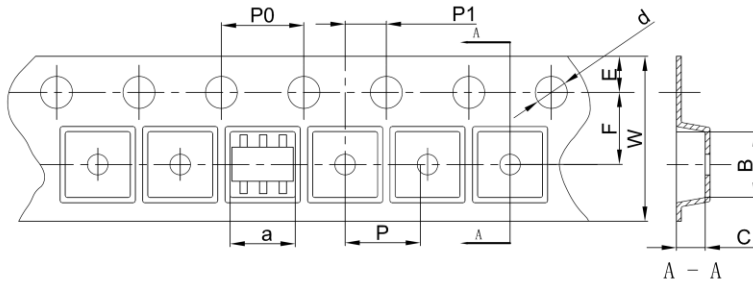

Dimensions are in millimeter										
Pkg type	a	B	C	d	E	F	P0	P	P1	W
SOT-23-6L	3.17	3.23	1.37	Ø1.55	1.75	3.50	4.00	4.00	2.00	8.00

SOT-23-6L Tape Leader and Trailer

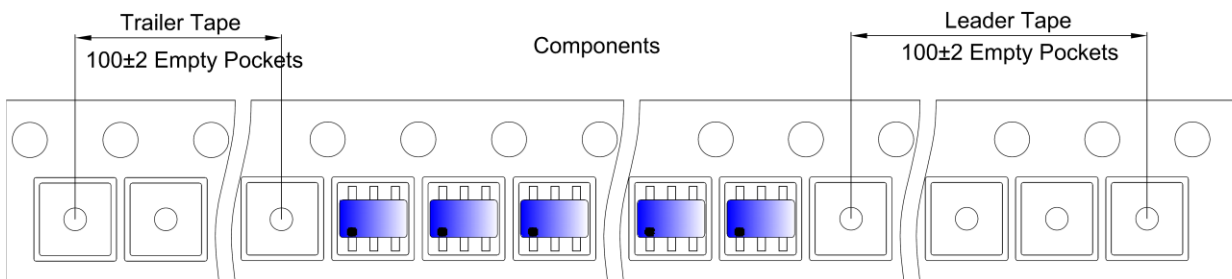

SOT-23-6L Reel

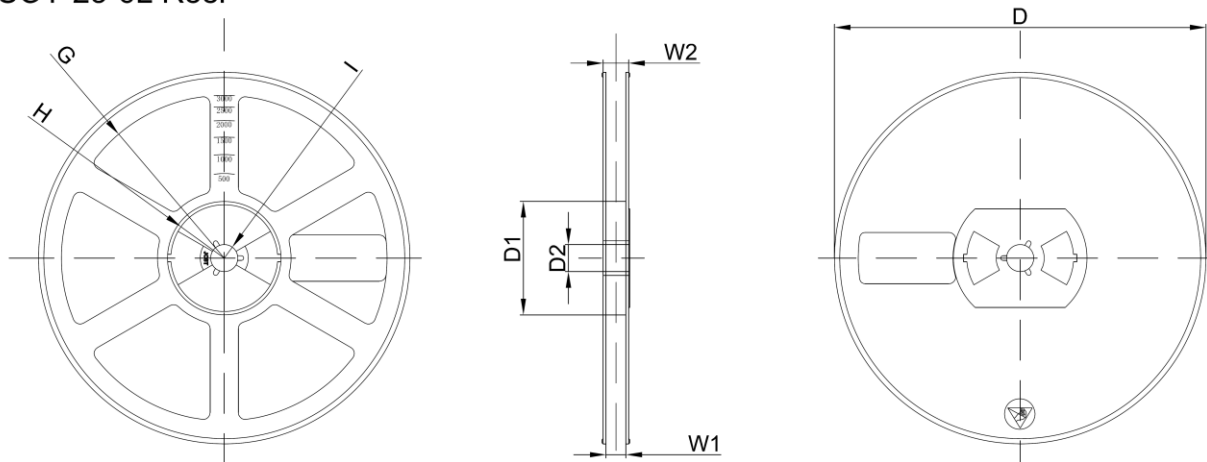

Dimensions are in millimeter								
Reel Option	D	D1	D2	G	H	I	W1	W2
7" Dia	Ø180.00	60.00	13.00	R78.00	R25.60	R6.50	9.50	13.10

REEL	Reel Size	Box	Box Size(mm)	Carton	Carton Size(mm)	G.W.(kg)
3000 pcs	7 inch	30,000 pcs	203×203×195	120,000 pcs	438×438×220	

单击下面可查看定价，库存，交付和生命周期等信息

[>>GP\(格瑞宝\)](#)