



Product Summary

$V_{(BR)DSS}$	$R_{DS(on)TYP}$	I_D
-12V	45mΩ@-4.5V	-3A
	61mΩ@-2.5V	
	85mΩ@-1.8V	

Feature

- TrenchFET Power MOSFET
- Excellent $R_{DS(on)}$ and Low Gate Charge

Application

- DC/DC Converter
- Load Switch for Portable Devices
- Battery Switch

MARKING:

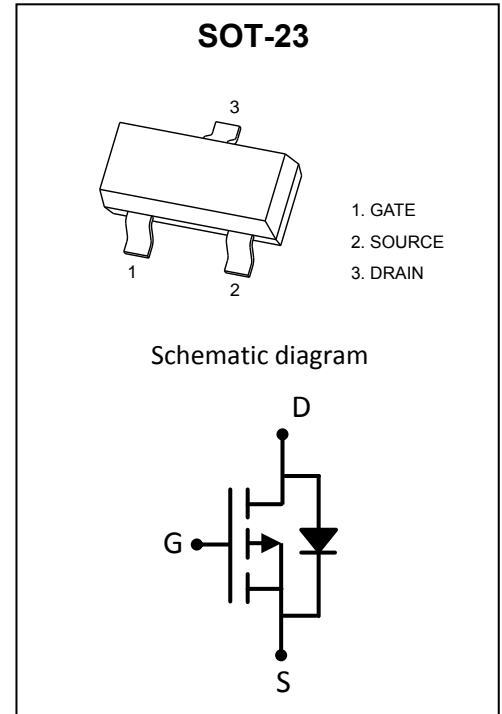
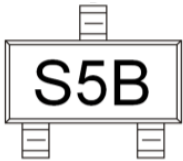

ABSOLUTE MAXIMUM RATINGS ($T_a=25^\circ\text{C}$ unless otherwise noted)

Parameter	Symbol	Value	Unit
Drain-Source Voltage	V_{DS}	-12	V
Gate-Source Voltage	V_{GS}	± 10	V
Continuous Drain Current	I_D	-3	A
Pulsed Drain Current ¹	I_{DM}	-10	A
Power Dissipation	P_D	0.35	W
Thermal Resistance from Junction to Ambient ²	$R_{\theta JA}$	357	$^\circ\text{C/W}$
Junction Temperature	T_J	150	$^\circ\text{C}$
Storage Temperature	T_{STG}	-55~ +150	$^\circ\text{C}$

MOSFET ELECTRICAL CHARACTERISTICS($T_a=25^{\circ}\text{C}$ unless otherwise noted)

Parameter	Symbol	Test Condition	Min	Type	Max	Unit
Static Characteristics						
Drain-source breakdown voltage	$V_{(BR)DSS}$	$V_{GS} = 0V, I_D = -250\mu A$	-12			V
Zero gate voltage drain current	I_{DSS}	$V_{DS} = -12V, V_{GS} = 0V$			-1	μA
Gate-body leakage current	I_{GSS}	$V_{GS} = \pm 8V, V_{DS} = 0V$			± 100	nA
Gate threshold voltage ³	$V_{GS(th)}$	$V_{DS} = V_{GS}, I_D = -250\mu A$	-0.5	-0.65	-0.9	V
Drain-source on-resistance ³	$R_{DS(on)}$	$V_{GS} = -4.5V, I_D = -2.6A$		45	58	m Ω
		$V_{GS} = -2.5V, I_D = -2.0A$		61	80	
		$V_{GS} = -1.8V, I_D = -1.0A$		85	130	
Forward transconductance ³	g_{FS}	$V_{DS} = -5V, I_D = -2A$	5			S
Dynamic characteristics⁴						
Input Capacitance	C_{iss}	$V_{DS} = -10V, V_{GS} = 0V, f = 1MHz$		405		pF
Output Capacitance	C_{oss}			75		
Reverse Transfer Capacitance	C_{rss}			55		
Gate resistance	R_g	$f = 1MHz$		6		Ω
Total Gate Charge	Q_g	$V_{DS} = -10V, V_{GS} = -2.5V, I_D = -3A$		3.3	12	nC
Gate-Source Charge	Q_{gs}			0.7		
Gate-Drain Charge	Q_{gd}			1.3		
Turn-on delay time	$t_{d(on)}$	$V_{DD} = -10V, V_{GEN} = -4.5V, I_D = -1A$ $R_L = 10\Omega, R_{GEN} = 1\Omega$		11		ns
Turn-on rise time	t_r			35		
Turn-off delay time	$t_{d(off)}$			30		
Turn-off fall time	t_f			10		
Source-Drain Diode characteristics						
Diode forward current	I_S	$T_C = 25^{\circ}\text{C}$			-3	A
Diode pulsed forward current ³	I_{SM}				-10	A
Diode Forward voltage	V_{DS}	$V_{GS} = 0V, I_S = -0.75A$		-0.85	-1.2	V

Notes:

1. Repetitive rating : Pulse width limited by junction temperature.
2. Surface mounted on FR4 board , $t_s \leq 10s$.
3. Pulse Test : Pulse Width $\leq 300\mu s$, Duty Cycle $\leq 0.5\%$.
4. Guaranteed by design, not subject to producing.

Typical Electrical and Thermal Characteristics

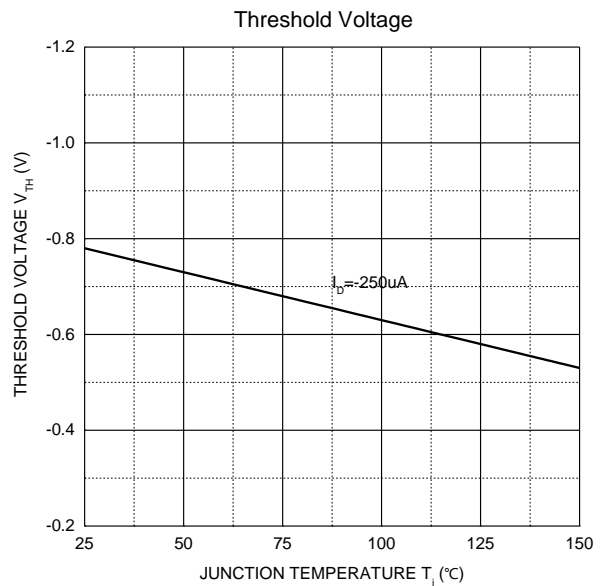
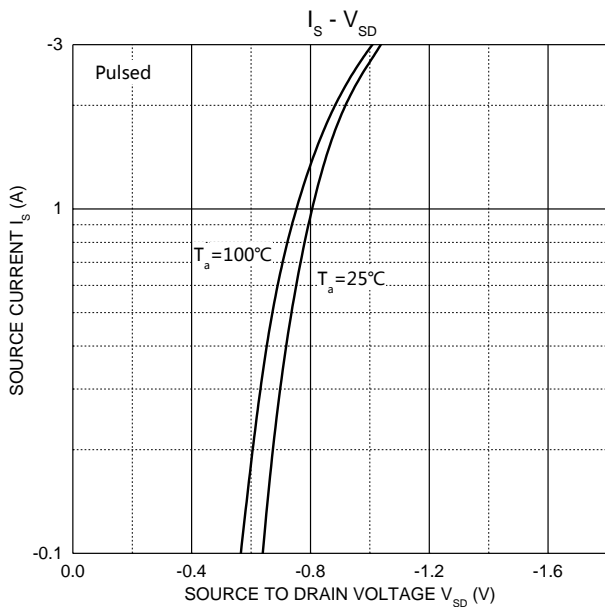
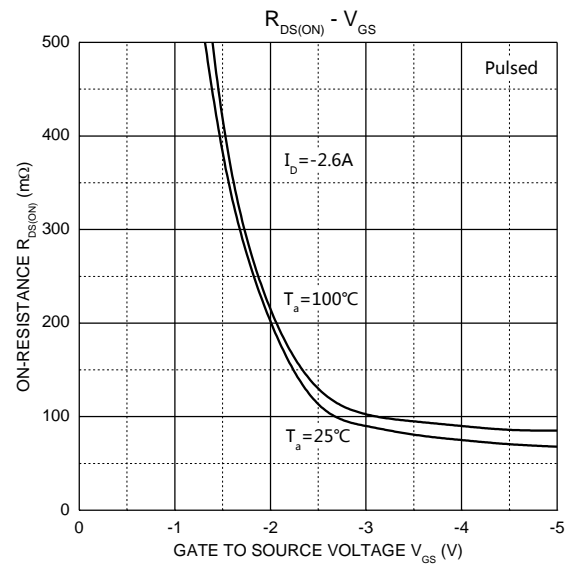
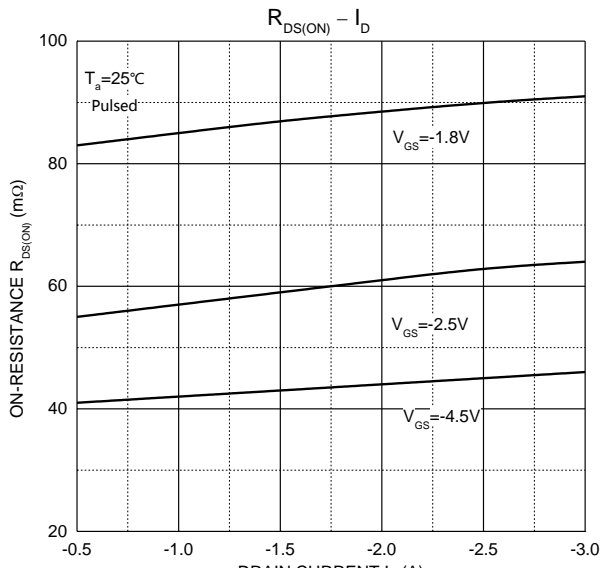
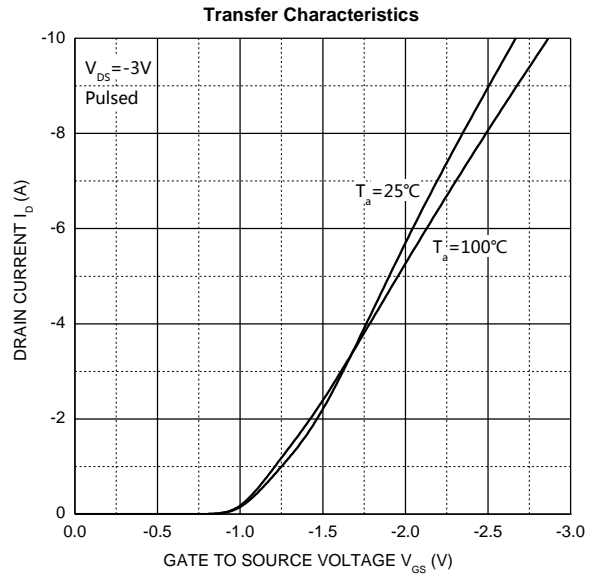
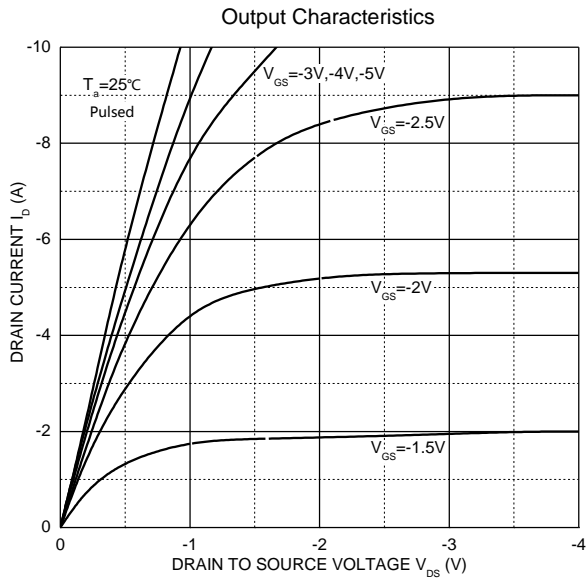

SOT-23 Package Information

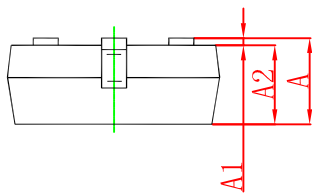
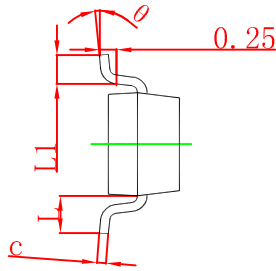
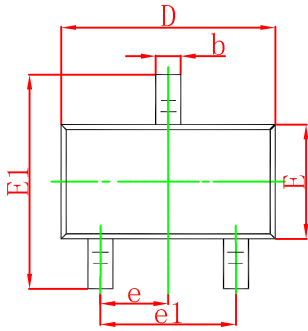

Symbol	Dimensions In Millimeters		Dimensions In Inches	
	Min	Max	Min	Max
A	0.900	1.150	0.035	0.045
A1	0.000	0.100	0.000	0.004
A2	0.900	1.050	0.035	0.041
b	0.300	0.500	0.012	0.020
c	0.080	0.150	0.003	0.006
D	2.800	3.000	0.110	0.118
E	1.200	1.400	0.047	0.055
E1	2.250	2.550	0.089	0.100
e	0.950 TYP		0.037 TYP	
e1	1.800	2.000	0.071	0.079
L	0.550 REF		0.022 REF	
L1	0.300	0.500	0.012	0.020
θ	0°	8°	0°	8°

SOT-23 Tape and Reel

SOT-23 Tape and reel

SOT-23 Embossed Carrier Tape

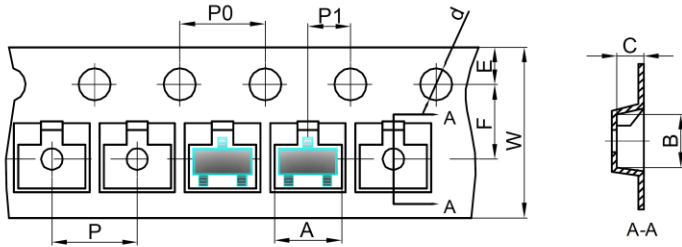

Dimensions are in millimeter

Pkg type	A	B	C	d	E	F	P0	P	P1	W
SOT-23	3.15	2.77	1.22	Ø1.50	1.75	3.50	4.00	4.00	2.00	8.00

SOT-23 Tape Leader and Trailer

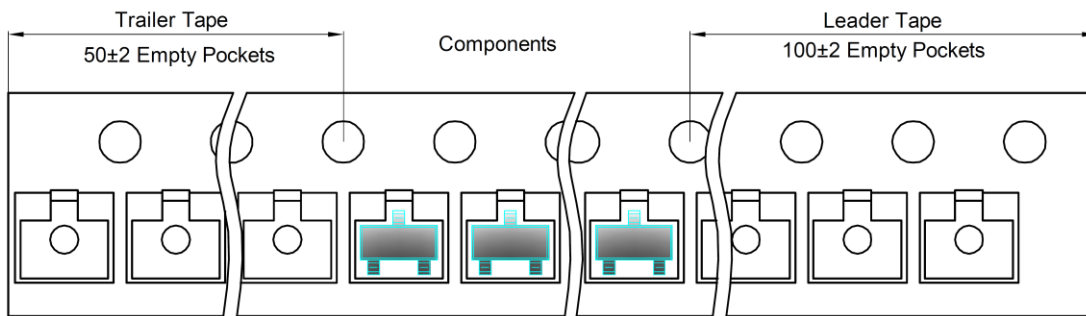

SOT-23 Reel

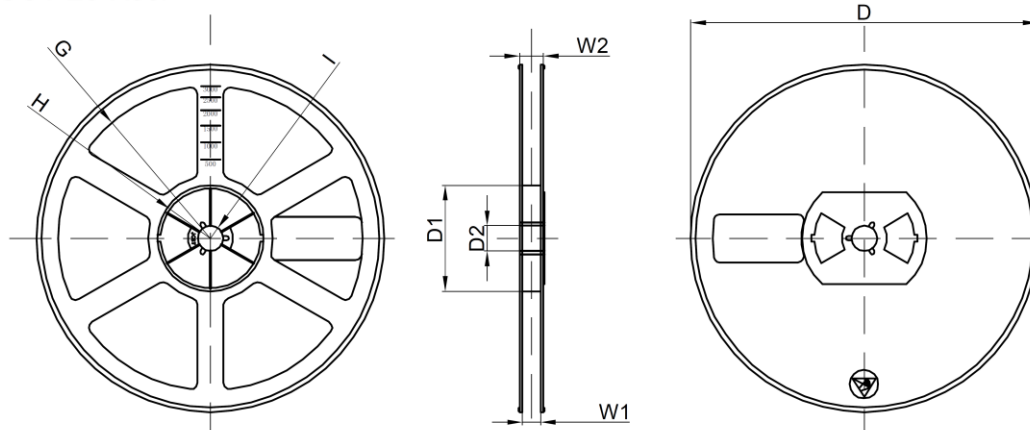

Dimensions are in millimeter

Reel Option	D	D1	D2	G	H	I	W1	W2
7" Dia	Ø178.00	54.40	13.00	R78.00	R25.60	R6.50	9.50	12.30

REEL	Reel Size	Box	Box Size(mm)	Carton	Carton Size(mm)	G.W.(kg)
3000 pcs	7 inch	30,000 pcs	203×203×195	120,000 pcs	438×438×220	

单击下面可查看定价，库存，交付和生命周期等信息

[>>GP\(格瑞宝\)](#)