



$V_{(BR)DSS}$	$R_{DS(on)}$ TYP	I_D
30V	4.0m Ω @10V	110A
	5.9m Ω @5.0V	

DESCRIPTION

The GP30N04DJ uses advanced trench technology and design to provide excellent $R_{DS(ON)}$ with low gate charge. It can be used in a wide variety of applications

FEATURE

- Excellent package for good heat dissipation
- Ultra low gate charge
- Low reverse transfer capacitance
- Fast switching capability
- Avalanche energy specified

APPLICATION

- Power switching application

MARKING

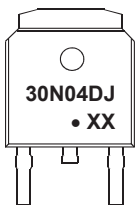

30N04DJ= Device code
Solid dot = Green molding compound device,
if none, the normal device
XX=Date Code

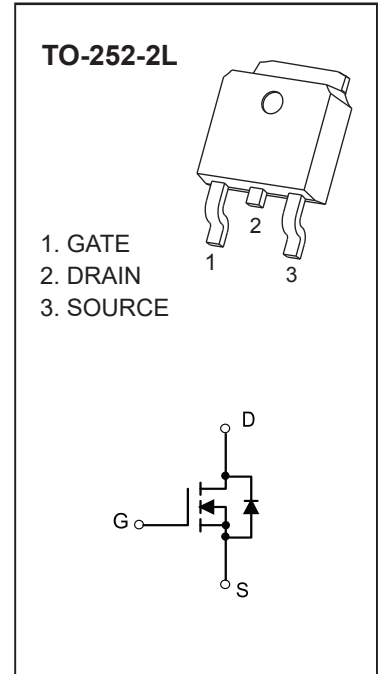

MAXIMUM RATINGS ($T_a=25^\circ\text{C}$ unless otherwise noted)

Parameter	Symbol	Limit	Unit
Drain-Source Voltage	V_{DS}	30	V
Gate-Source Voltage	V_{GS}	± 20	V
Continuous Drain Current	I_D	110	A
Pulsed Drain Current	I_{DM}	380	A
Single Pulsed Avalanche Energy	$E_{AS}^{(1)}$	120	mJ
Power Dissipation	P_D	1.25	W
Thermal Resistance from Junction to Ambient	$R_{\theta JA}$	100	$^\circ\text{C/W}$
Junction Temperature	T_J	150	$^\circ\text{C}$
Storage Temperature Range	T_{stg}	-55 ~ +150	$^\circ\text{C}$
Lead Temperature for Soldering Purposes(1/8" from case for 10s)	T_L	260	$^\circ\text{C}$

(1).EAS condition: $V_{DD}=20V, V_{GS}=10V, L=1mH, R_G=25\Omega$, Starting $T_J = 25^\circ\text{C}$

(2).Mounted on a glass epoxy board of 25.4 mm x 25.4 mm x 0.8 mmt

MOSFET ELECTRICAL CHARACTERISTICS(T_c=25°C unless otherwise noted)

Parameter	Symbol	Test Condition	Min	Typ	Max	Unit
Off characteristics						
Drain-source breakdown voltage	V _{(BR)DSS}	V _{GS} = 0V, I _D =250μA	30			V
Zero gate voltage drain current	I _{DSS}	V _{DS} =24V, V _{GS} =0V			1	μA
Gate-body leakage current	I _{GSS}	V _{DS} =0V, V _{GS} =±20V			±100	nA
On characteristics (note1)						
Gate-threshold voltage	V _{GS(th)}	V _{DS} =V _{GS} , I _D =250μA	1.0	1.5	2.5	V
Static drain-source on-state resistance	R _{DS(on)}	V _{GS} =10V, I _D =20A		4.0	5.0	mΩ
		V _{GS} =5V, I _D =20A		5.9	7.8	mΩ
Dynamic characteristics (note 2)						
Input capacitance	C _{iss}	V _{DS} =15V, V _{GS} =0V, f =1MHz		1850		pF
Output capacitance	C _{oss}			318		
Reverse transfer capacitance	C _{rss}			303		
Gate resistance	R _g	V _{GS} =0V, V _{DS} =0V, F=1MHz		4.5		Ω
Switching characteristics (note 2)						
Total gate charge	Q _g	V _{GS} =10V, V _{DS} =25V, I _D =14A		46.1		nC
Gate-source charge	Q _{gs}			25.4		
Gate-drain charge	Q _{gd}			32.4		
Turn-on delay time	t _{d(on)}	V _{DS} =15V, R _L =0.75Ω, V _{GS} =10V, R _G =3Ω		12		ns
Turn-on rise time	t _r			36		
Turn-off delay time	t _{d(off)}			49		
Turn-off fall time	t _f			12		
Drain-Source Diode Characteristics						
Drain-source diode forward voltage(note1)	V _{SD}	V _{GS} =0V, I _S =20A			1.2	V
Continuous drain-source diode forward current	I _S				110	A
Pulsed drain-source diode forward current	I _{SM}				380	A

Notes:

1. Pulse Test : Pulse Width≤300μs, duty cycle ≤2%.
2. Guaranteed by design, not subject to production.

Typical Electrical and Thermal Characteristics

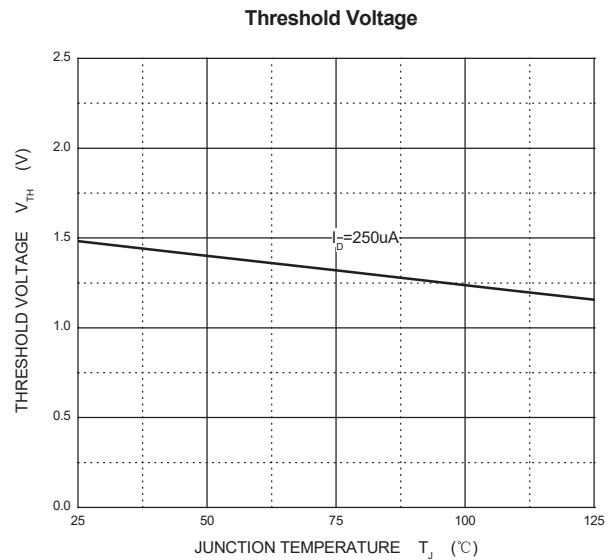
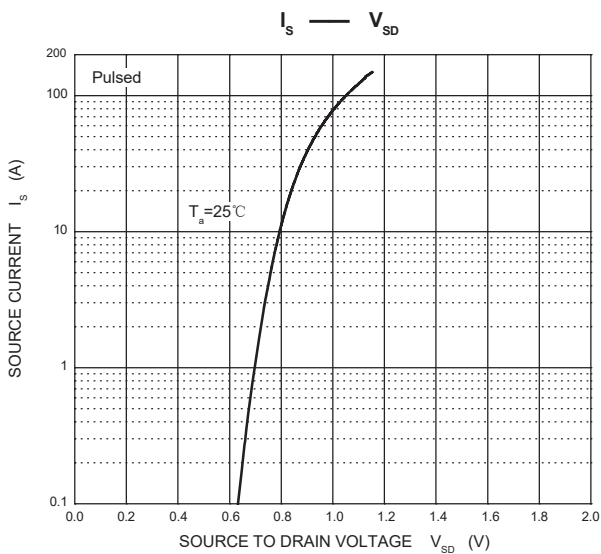
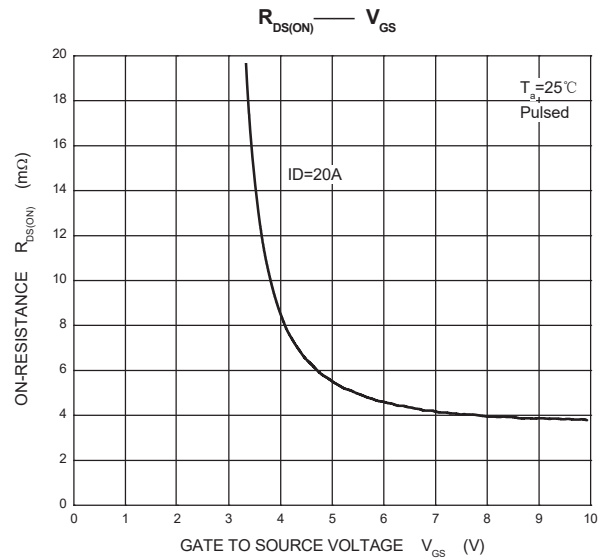
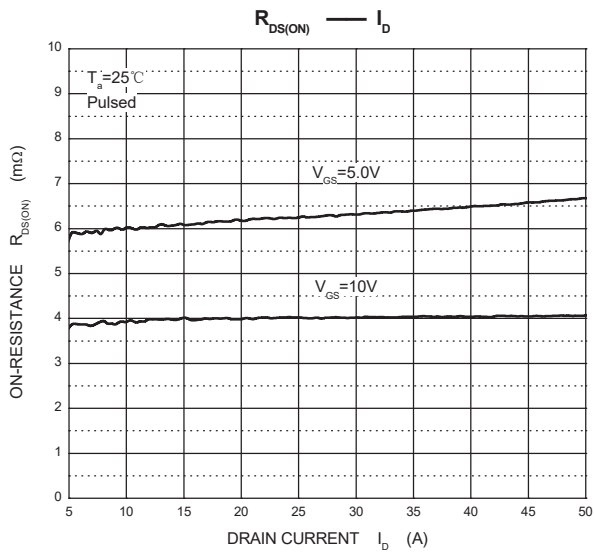
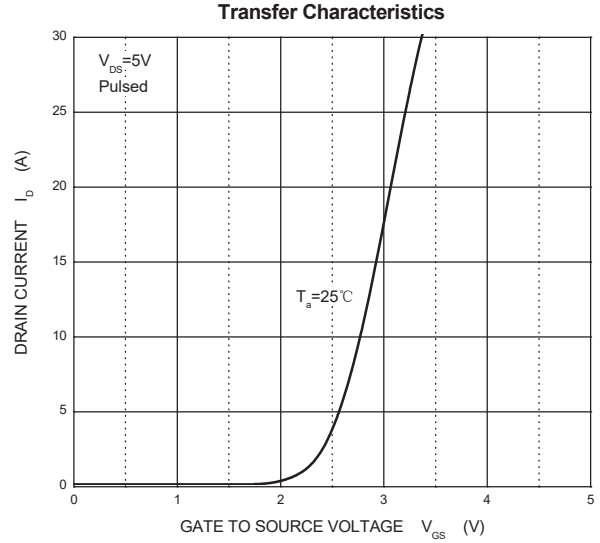
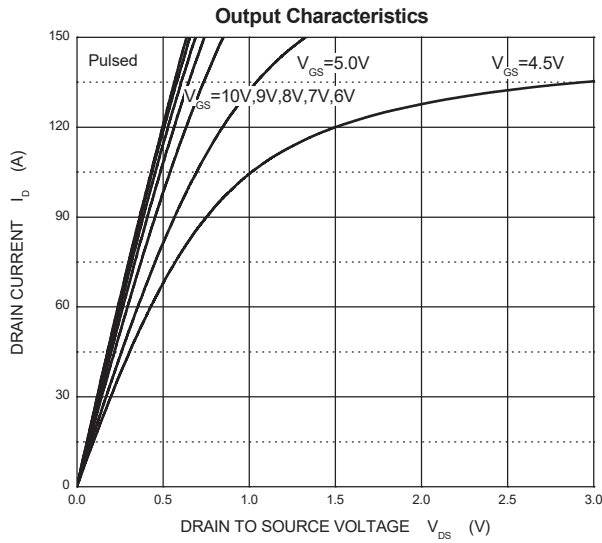

Typical Electrical and Thermal Characteristics

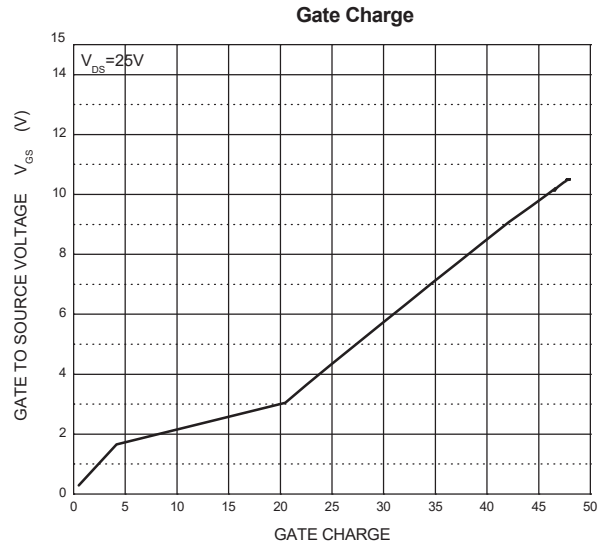
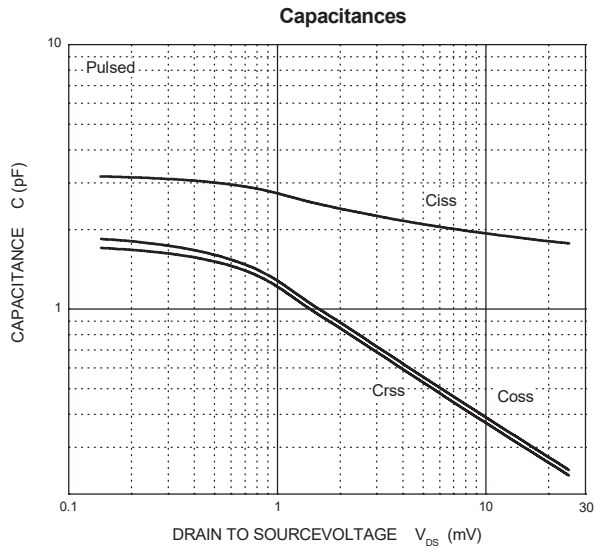

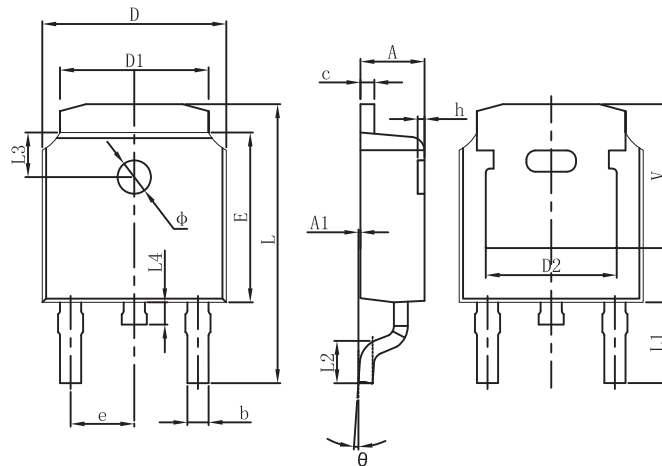
TO-252 Package Information

Symbol	Dimensions In Millimeters		Dimensions In Inches	
	Min.	Max.	Min.	Max.
A	2.200	2.400	0.087	0.094
A1	0.000	0.127	0.000	0.005
b	0.635	0.770	0.025	0.030
c	0.460	0.580	0.018	0.023
D	6.500	6.700	0.256	0.264
D1	5.100	5.460	0.201	0.215
D2	4.830 REF.		0.190 REF.	
E	6.000	6.200	0.236	0.244
e	2.186	2.386	0.086	0.094
L	9.712	10.312	0.382	0.406
L1	2.900 REF.		0.114 REF.	
L2	1.400	1.700	0.055	0.067
L3	1.600 REF.		0.063 REF.	
L4	0.600	1.000	0.024	0.039
Φ	1.100	1.300	0.043	0.051
θ	0°	8°	0°	8°
h	0.000	0.300	0.000	0.012
V	5.250 REF.		0.207 REF.	

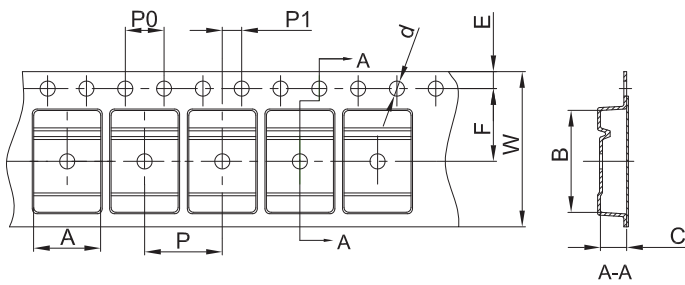
TO-252 Tape and Reel
TO-252 Embossed Carrier Tape

Dimensions are in millimeter										
Pkg type	A	B	C	d	E	F	P0	P	P1	W
TO-252	6.90	10.50	2.70	Ø1.55	1.75	7.50	4.00	8.00	2.00	16.00

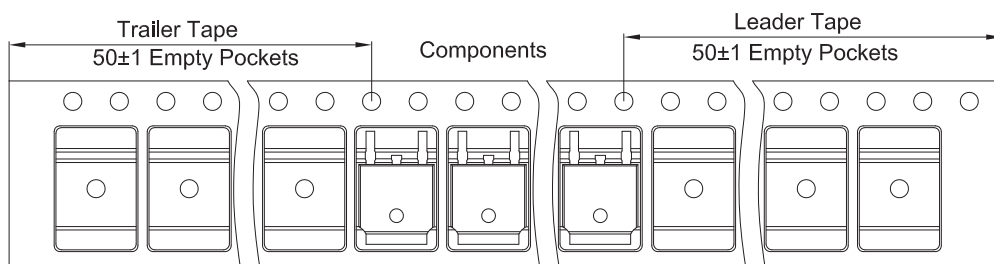
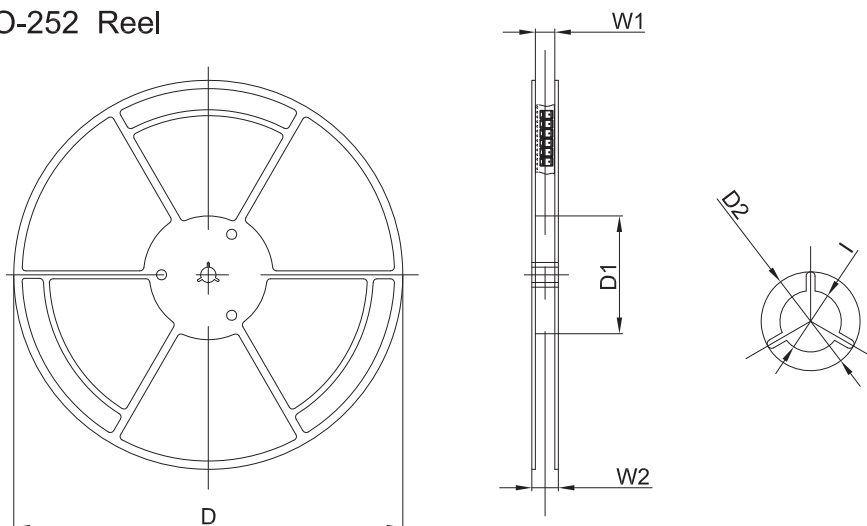
TO-252 Tape Leader and Trailer

TO-252 Reel

Dimensions are in millimeter						
Reel Option	D	D1	D2	W1	W2	I
13" Dia	330.00	100.00	Ø21.00	16.40	21.00	Ø13.00

REEL	Reel Size	Box	Box Size(mm)	Carton	Carton Size(mm)	G.W.(kg)
2,500 pcs	13inch	2,500 pcs	340×336×29	25,000 pcs	353×346×365	

单击下面可查看定价，库存，交付和生命周期等信息

[>>GP\(格瑞宝\)](#)