



#### Product Summary

$V_{(BR)DSS}$	$R_{DS(on)TYP}$	$I_D$
20V	190mΩ@4.5V	0.75A
	260mΩ@2.5V	
	390mΩ@1.8V	

#### Feature

- High-Side Switching
- Low On-Resistance
- Low Threshold
- Fast Switching Speed
- ESD Protected

#### Application

- Drivers: Relays, Solenoids, Lamps, Hammers, Displays, Memories
- Battery Operated Systems
- Power Supply Converter Circuits
- Load/Power Switching Cell Phones, Pagers

#### MARKING:

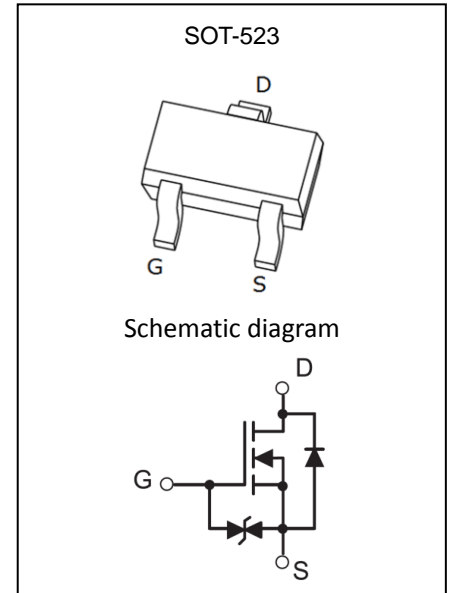

#### ABSOLUTE MAXIMUM RATINGS ( $T_a=25^\circ\text{C}$ unless otherwise noted)

Parameter	Symbol	Value	Unit
Drain-Source Voltage	$V_{DS}$	20	V
Gate-Source Voltage	$V_{GS}$	$\pm 12$	V
Continuous Drain Current	$I_D$	0.75	A
Pulsed Drain Current ( $t=300\mu\text{s}$ ) <sup>(1)</sup>	$I_{DM}$	3	A
Power Dissipation <sup>(2)</sup>	$P_D$	150	mW
Thermal Resistance from Junction to Ambient	$R_{\theta JA}$	833	$^\circ\text{C}/\text{W}$
Junction Temperature	$T_J$	150	$^\circ\text{C}$
Storage Temperature	$T_{STG}$	-55~ +150	$^\circ\text{C}$

**MOSFET ELECTRICAL CHARACTERISTICS(T<sub>a</sub>=25°C unless otherwise noted)**

Parameter	Symbol	Test Condition	Min	Type	Max	Unit
<b>Static Characteristics</b>						
Drain-source breakdown voltage	V <sub>(BR)DSS</sub>	V <sub>GS</sub> = 0V, I <sub>D</sub> =250μA	20			V
Zero gate voltage drain current	I <sub>DSS</sub>	V <sub>DS</sub> =20V, V <sub>GS</sub> = 0V			1	μA
Gate-body leakage current	I <sub>GSS</sub>	V <sub>GS</sub> =±10V, V <sub>DS</sub> = 0V			±20	μA
Gate threshold voltage <sup>(3)</sup>	V <sub>GS(th)</sub>	V <sub>DS</sub> =V <sub>GS</sub> , I <sub>D</sub> =250μA	0.35	0.75	1.1	V
Drain-source on-resistance <sup>(3)</sup>	R <sub>DS(on)</sub>	V <sub>GS</sub> =4.5V, I <sub>D</sub> =650mA		190	260	mΩ
		V <sub>GS</sub> =2.5V, I <sub>D</sub> =550mA		260	360	
		V <sub>GS</sub> =1.8V, I <sub>D</sub> =450mA		390	590	
Forward tranconductance	g <sub>FS</sub>	V <sub>DS</sub> =10V, I <sub>D</sub> =800mA	1			S
<b>Dynamic characteristics<sup>(4)</sup></b>						
Input Capacitance	C <sub>iss</sub>	V <sub>DS</sub> =16V, V <sub>GS</sub> =0V, f =1MHz			120	pF
Output Capacitance	C <sub>oss</sub>				20	
Reverse Transfer Capacitance	C <sub>rss</sub>				15	
<b>Switching Characteristics<sup>(4)</sup></b>						
Turn-on delay time	t <sub>d(on)</sub>	V <sub>DD</sub> =10V, I <sub>D</sub> =500mA, V <sub>GS</sub> =4.5V, R <sub>G</sub> =10Ω		6.7		ns
Turn-on rise time	t <sub>r</sub>			4.8		
Turn-off delay time	t <sub>d(off)</sub>			17.3		
Turn-off fall time	t <sub>f</sub>			7.4		
<b>Source-Drain Diode characteristics</b>						
Diode Forward voltage <sup>(3)</sup>	V <sub>DS</sub>	I <sub>S</sub> =0.15A, V <sub>GS</sub> = 0V			1.2	V

**Notes:**

1. Repetitive Rating: Pulse width limited by maximum junction temperature.
2. This test is performed with no heat sink at T<sub>a</sub>=25°C.
3. Pulse Test : Pulse Width≤300μs, Duty Cycle≤0.5%.
4. These parameters have no way to verify.

**Typical Electrical and Thermal Characteristics**

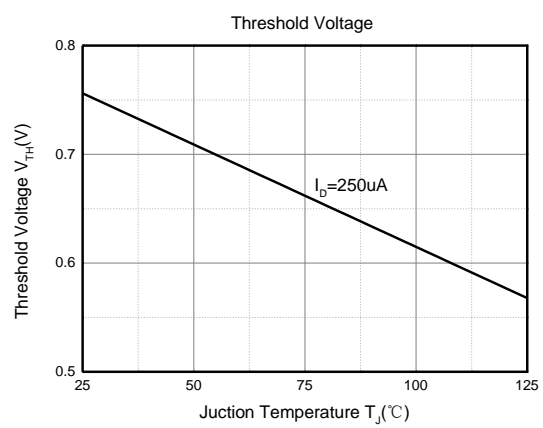
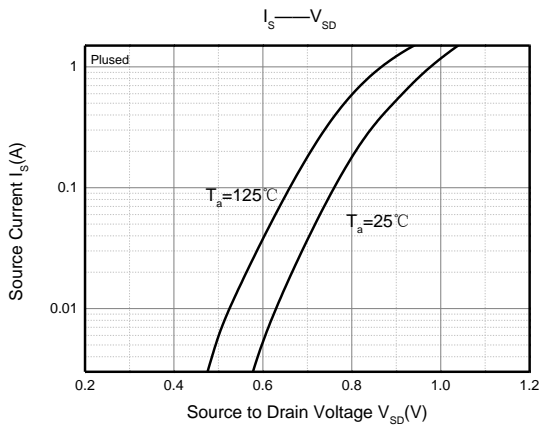
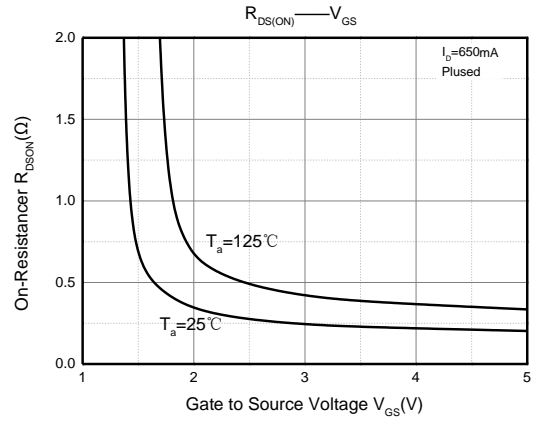
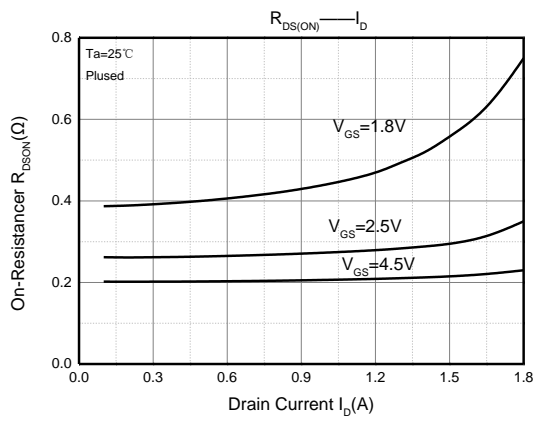
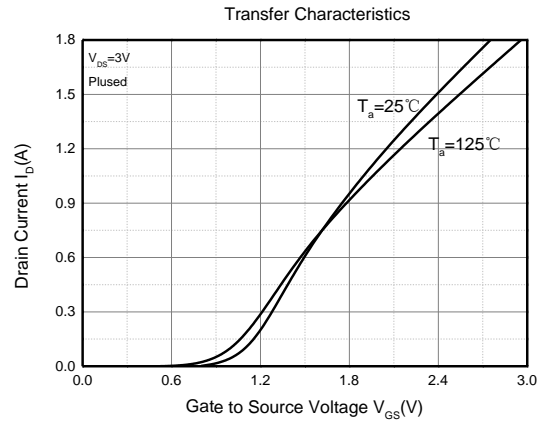
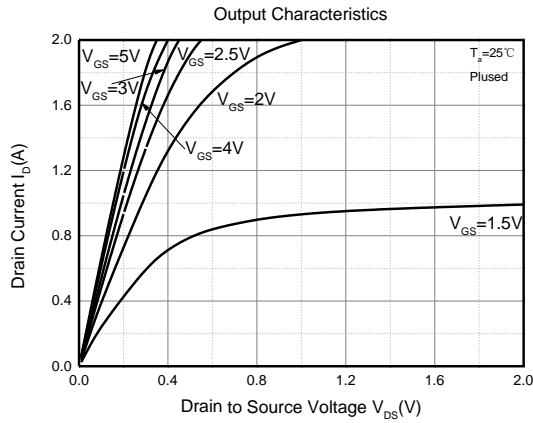

**SOT-523 Package Information**

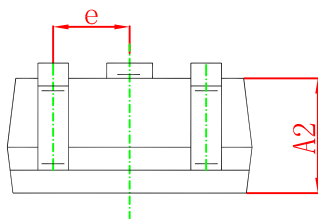
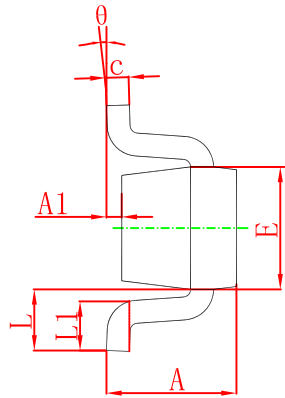
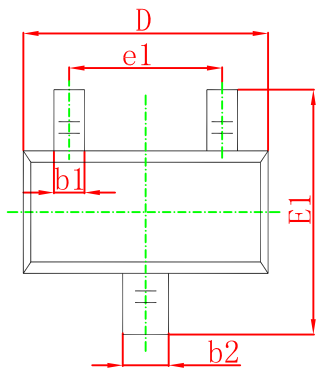

Symbol	Dimensions In Millimeters		Dimensions In Inches	
	Min.	Max.	Min.	Max.
A	0.700	0.900	0.028	0.035
A1	0.000	0.100	0.000	0.004
A2	0.700	0.800	0.028	0.031
b1	0.150	0.250	0.006	0.010
b2	0.250	0.350	0.010	0.014
c	0.100	0.200	0.004	0.008
D	1.500	1.700	0.059	0.067
E	0.700	0.900	0.028	0.035
E1	1.450	1.750	0.057	0.069
e	0.500 TYP.		0.020 TYP.	
e1	0.900	1.100	0.035	0.043
L	0.400 REF.		0.016 REF.	
L1	0.260	0.460	0.010	0.018
theta	0°	8°	0°	8°

**SOT-523 Tape and Reel**

**SOT-523 Tape and reel**

SOT-523 Embossed Carrier Tape

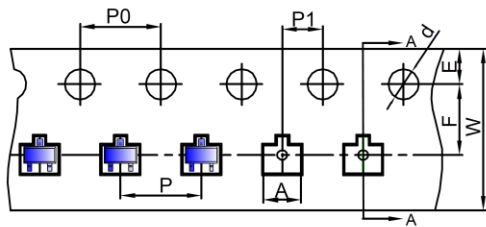

Dimensions are in millimeter										
Pkg type	A	B	C	d	E	F	P0	P	P1	W
SOT-523	1.85	1.85	0.875	Ø1.50	1.75	3.50	4.00	4.00	2.00	8.00

**SOT-523 Tape Leader and Trailer**

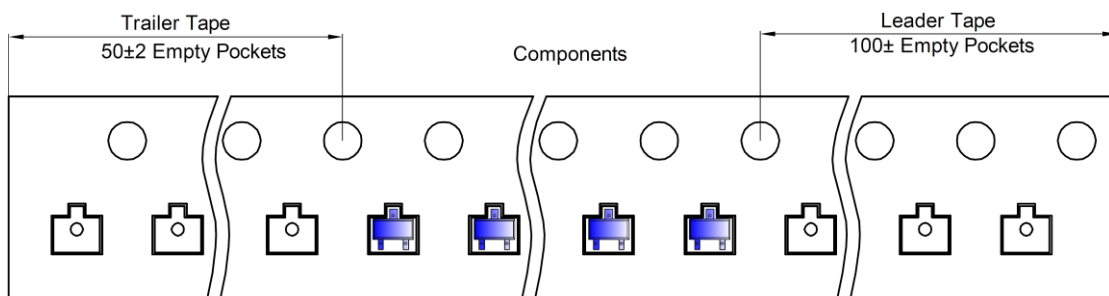

**SOT-523 Reel**

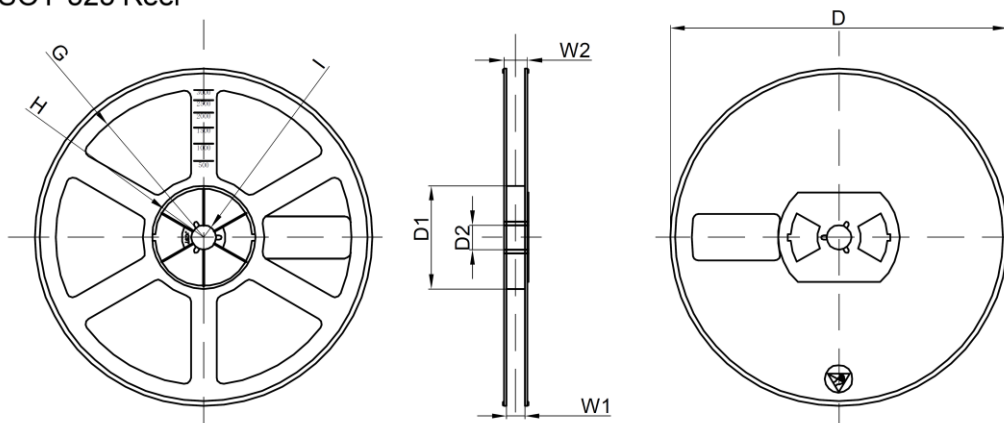

Dimensions are in millimeter								
Reel Option	D	D1	D2	G	H	I	W1	W2
7" Dia	Ø178.00	54.40	13.00	R78.00	R25.60	R6.50	9.50	12.30

REEL	Reel Size	Box	Box Size(mm)	Carton	Carton Size(mm)	G.W.(kg)
3000 pcs	7 inch	30,000 pcs	203×203×195	120,000 pcs	438×438×220	

单击下面可查看定价，库存，交付和生命周期等信息

[>>GP\(格瑞宝\)](#)