



Product Summary

$V_{(BR)DSS}$	$R_{DS(on)TYP}$	I_D
-20V	450mΩ@-4.5V	-0.66A
	650mΩ@-2.5V	
	950mΩ@-1.8V	

Feature

- Surface Mount Package
- P-Channel Switch with Low RDS(on)
- Operated at Low Logic Level Gate Drive

Application

- Load/Power Switching
- Interfacing, Logic Switching
- Battery Management for Ultra Small Portable Electronics

MARKING:

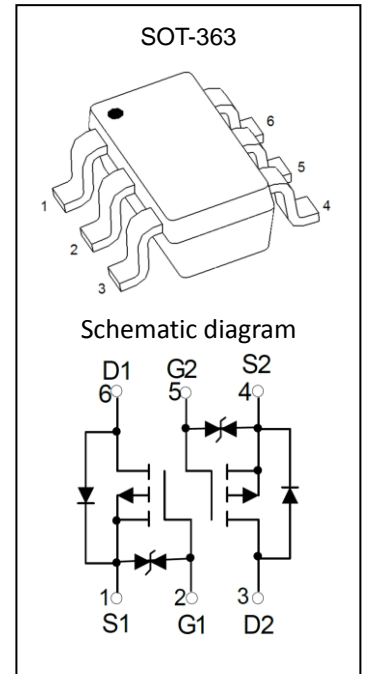
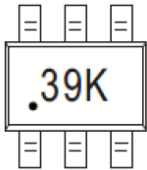

ABSOLUTE MAXIMUM RATINGS ($T_a=25^{\circ}C$ unless otherwise noted)

Parameter	Symbol	Value	Unit
Drain-Source Voltage	V_{DS}	-20	V
Gate-Source Voltage	V_{GS}	± 12	V
Continuous Drain Current	I_D	-0.66	A
Pulsed Drain Current ⁽¹⁾	I_{DM}	-1.8	A
Power Dissipation ⁽²⁾	P_D	150	mW
Thermal Resistance from Junction to Ambient ⁽¹⁾	$R_{\theta JA}$	833	$^{\circ}C/W$
Junction Temperature	T_J	150	$^{\circ}C$
Storage Temperature	T_{STG}	-55~ +150	$^{\circ}C$

MOSFET ELECTRICAL CHARACTERISTICS(T_a=25°C unless otherwise noted)

Parameter	Symbol	Test Condition	Min	Type	Max	Unit
Static Characteristics						
Drain-source breakdown voltage	V _{(BR)DSS}	V _{GS} = 0V, I _D = -250μA	-20			V
Zero gate voltage drain current	I _{DSS}	V _{DS} = -20V, V _{GS} = 0V			-1	μA
Gate-body leakage current	I _{GSS}	V _{GS} = ±10V, V _{DS} = 0V			±20	μA
Gate threshold voltage ⁽³⁾	V _{GS(th)}	V _{DS} = V _{GS} , I _D = -250μA	-0.35	-0.61	-1.1	V
Drain-source on-resistance ⁽³⁾	R _{DS(on)}	V _{GS} = -4.5V, I _D = -1A		450	580	mΩ
		V _{GS} = -2.5V, I _D = -0.8A		650	840	
		V _{GS} = -1.8V, I _D = -0.5A		950		
Forward tranconductance	g _{FS}	V _{DS} = -10V, I _D = -0.54A	0.8			S
Dynamic characteristics⁽⁴⁾						
Input Capacitance	C _{iss}	V _{DS} = -16V, V _{GS} = 0V, f = 1MHz		113		pF
Output Capacitance	C _{oss}			15		
Reverse Transfer Capacitance	C _{rss}			9		
Switching Characteristics⁽⁴⁾						
Turn-on delay time	t _{d(on)}	V _{DS} = -10V, I _D = -200mA, V _{GS} = -4.5V, R _G = 10Ω		9		ns
Turn-on rise time	t _r			5.7		
Turn-off delay time	t _{d(off)}			32.6		
Turn-off fall time	t _f			20.3		
Source-Drain Diode characteristics						
Diode forward voltage ⁽³⁾	V _{DS}	I _S = -0.5A, V _{GS} = 0V			-1.2	V

Notes:

1. Repetitive Rating: Pulse width limited by maximum junction temperature.
2. This test is performed with no heat sink at T_a=25°C.
3. Pulse Test : Pulse Width ≤ 300μs, Duty Cycle ≤ 0.5%.
4. These parameters have no way to verify.

Typical Electrical and Thermal Characteristics

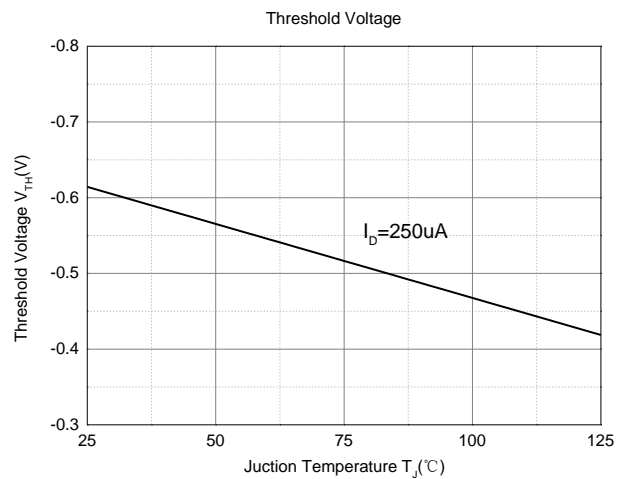
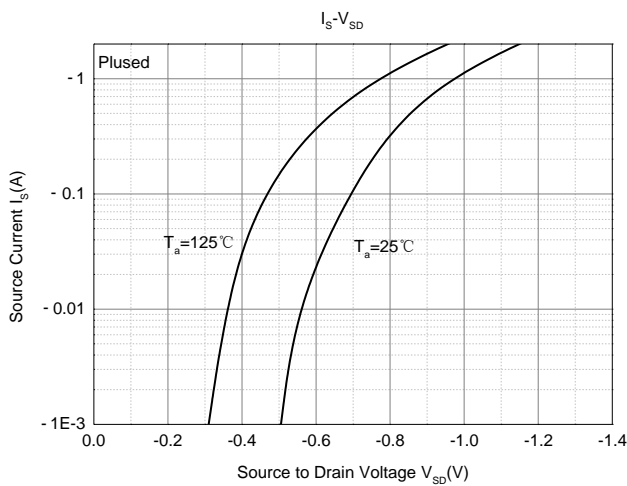
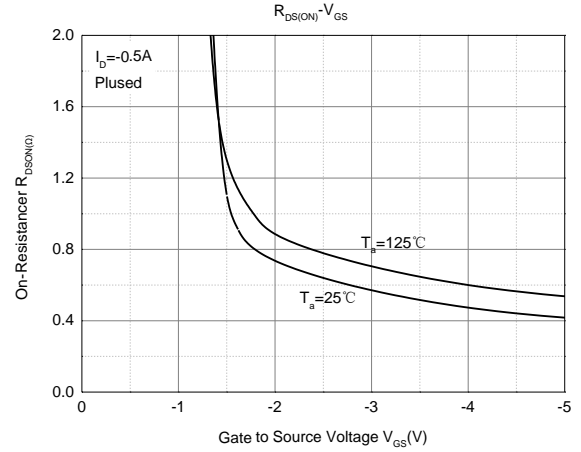
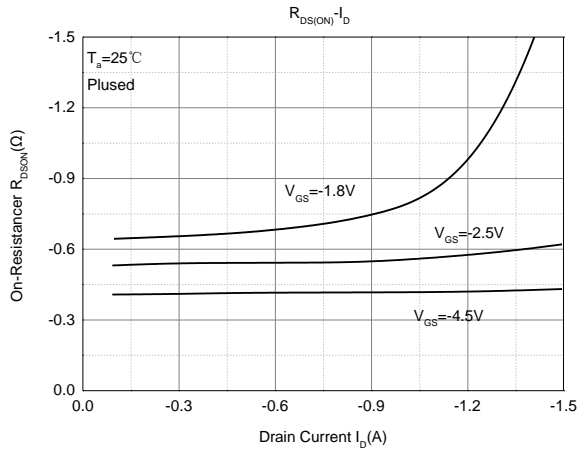
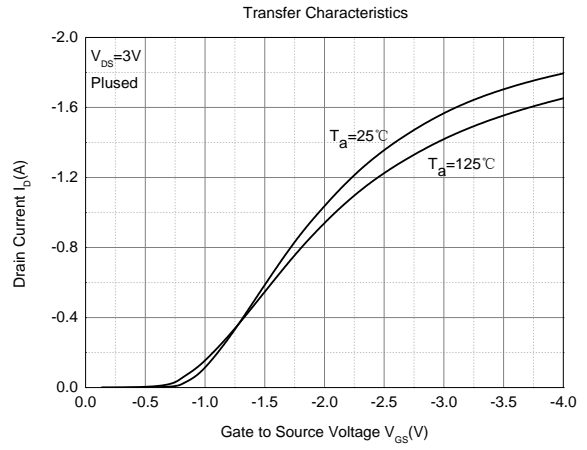
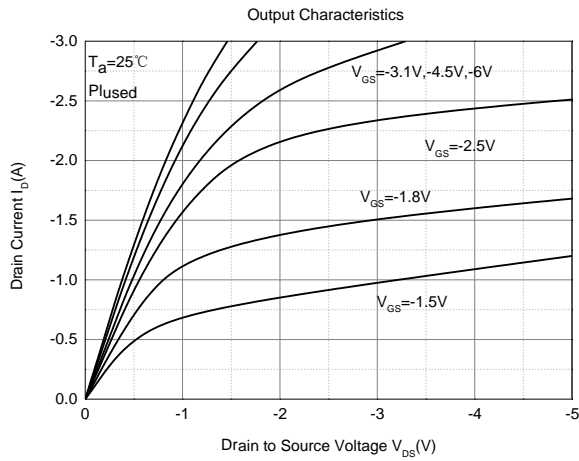

SOT-363 Package Information

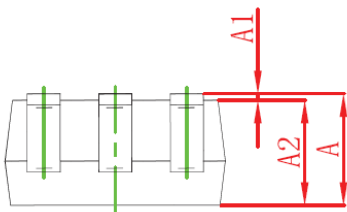
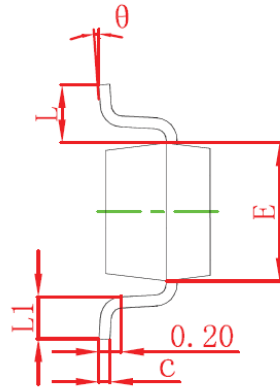
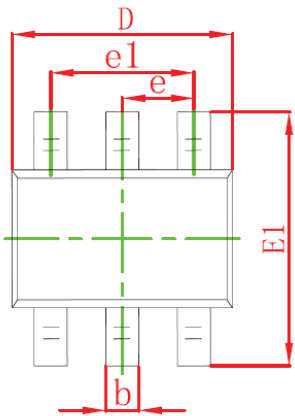

Symbol	Dimensions In Millimeters		Dimensions In Inches	
	Min	Max	Min	Max
A	0.900	1.100	0.035	0.043
A1	0.000	0.100	0.000	0.004
A2	0.900	1.000	0.035	0.039
b	0.150	0.350	0.006	0.014
c	0.100	0.150	0.004	0.006
D	2.000	2.200	0.079	0.087
E	1.150	1.350	0.045	0.053
E1	2.150	2.400	0.085	0.094
e	0.650 TYP		0.026 TYP	
e1	1.200	1.400	0.047	0.055
L	0.525 REF		0.021 REF	
L1	0.260	0.460	0.010	0.018
θ	0°	8°	0°	8°

SOT-363 Tape and Reel

SOT-363 Tape and reel

SOT-363 Embossed Carrier Tape

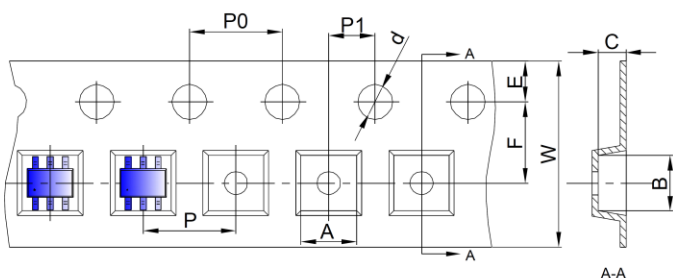

Dimensions are in millimeter										
Pkg type	A	B	C	d	E	F	P0	P	P1	W
SOT-363	2.25	2.55	1.20	Ø1.50	1.75	3.50	4.00	4.00	2.00	8.00

SOT-363 Tape Leader and Trailer

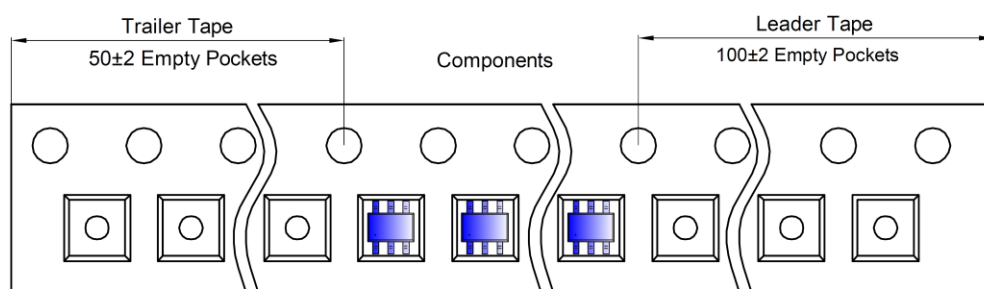

SOT-363 Reel

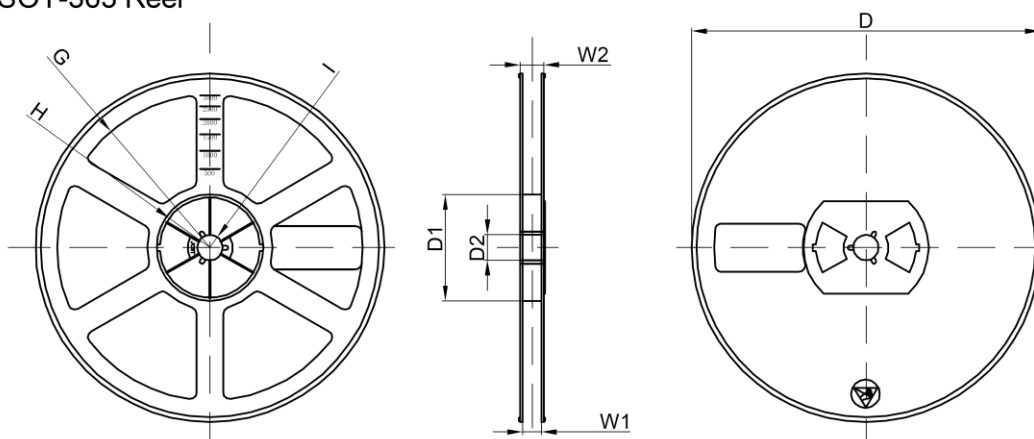

Dimensions are in millimeter								
Reel Option	D	D1	D2	G	H	I	W1	W2
7" Dia	Ø178.00	54.40	13.00	R78.00	R25.60	R6.50	9.50	12.30

REEL	Reel Size	Box	Box Size(mm)	Carton	Carton Size(mm)	G.W.(kg)
3000 pcs	7 inch	30,000 pcs	203×203×195	120,000 pcs	438×438×220	

单击下面可查看定价，库存，交付和生命周期等信息

[>>GP\(格瑞宝\)](#)