



Product Summary

$V_{(BR)DSS}$	$R_{DS(on)TYP}$	I_D
30V	20m Ω @10V	5.8A
	22m Ω @4.5V	
	25m Ω @2.5V	

Feature

- TrenchFET Power MOSFET
- Excellent $R_{DS(on)}$ and Low Gate Charge

Application

- DC/DC Converter
- Load Switch for Portable Devices
- Battery Switch

MARKING:

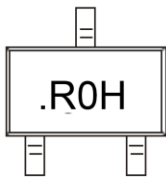

SOT-23-3L

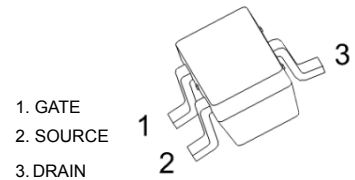

Schematic diagram

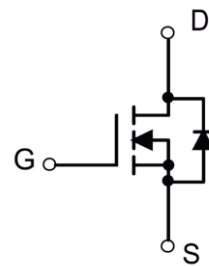

ABSOLUTE MAXIMUM RATINGS ($T_a=25^\circ\text{C}$ unless otherwise noted)

Parameter	Symbol	Value	Unit
Drain-Source Voltage	V_{DS}	30	V
Gate-Source Voltage	V_{GS}	± 12	V
Continuous Drain Current	I_D	5.8	A
Pulsed Drain Current ⁽¹⁾	I_{DM}	30	A
Power Dissipation	P_D	0.4	W
Thermal Resistance from Junction to Ambient ⁽²⁾	$R_{\theta JA}$	313	$^\circ\text{C/W}$
Junction Temperature	T_J	150	$^\circ\text{C}$
Storage Temperature	T_{STG}	-55~ +150	$^\circ\text{C}$

MOSFET ELECTRICAL CHARACTERISTICS($T_a=25^{\circ}\text{C}$ unless otherwise noted)

Parameter	Symbol	Test Condition	Min	Type	Max	Unit
Static Characteristics						
Drain-source breakdown voltage	$V_{(BR)DSS}$	$V_{GS} = 0V, I_D = 250\mu A$	30			V
Zero gate voltage drain current	I_{DSS}	$V_{DS} = 24V, V_{GS} = 0V$			1	μA
Gate-body leakage current	I_{GSS}	$V_{GS} = \pm 12V, V_{DS} = 0V$			± 0.1	μA
Gate threshold voltage ⁽³⁾	$V_{GS(th)}$	$V_{DS} = V_{GS}, I_D = 250\mu A$	0.7	1.0	1.4	V
Drain-source on-resistance ⁽³⁾	$R_{DS(on)}$	$V_{GS} = 10V, I_D = 5.8A$		20	27	m Ω
		$V_{GS} = 4.5V, I_D = 5A$		22	30	
		$V_{GS} = 2.5V, I_D = 4A$		25	35	
Forward tranconductance ⁽³⁾	g_{FS}	$V_{DS} = 5V, I_D = 5A$	8			S
Dynamic characteristics⁽⁴⁾						
Input Capacitance	C_{iss}	$V_{DS} = 15V, V_{GS} = 0V, f = 1MHz$			1155	pF
Output Capacitance	C_{oss}			108		
Reverse Transfer Capacitance	C_{rss}			84		
Gate resistance	R_g	$V_{DS} = 0V, V_{GS} = 0V, f = 1MHz$			3.6	Ω
Switching Characteristics⁽⁴⁾						
Turn-on delay time	$t_{d(on)}$	$V_{GS} = 10V, V_{DS} = 15V,$ $R_L = 2.7\Omega, R_{GEN} = 3\Omega$			5	ns
Turn-on rise time	t_r				7	
Turn-off delay time	$t_{d(off)}$				40	
Turn-off fall time	t_f				6	
Source-Drain Diode characteristics						
Diode Forward voltage ⁽³⁾	V_{SD}	$V_{GS} = 0V, I_S = 1A$			1	V

Notes:

1. Repetitive Rating : Pulse width limited by maximum junction temperature.
2. Surface Mounted on FR4 Board, $t < 5\text{sec}$.
3. Pulse Test : Pulse Width $\leq 300\mu s$, Duty Cycle $\leq 2\%$.
4. Guaranteed by design, not subject to production testing.

Typical Electrical and Thermal Characteristics

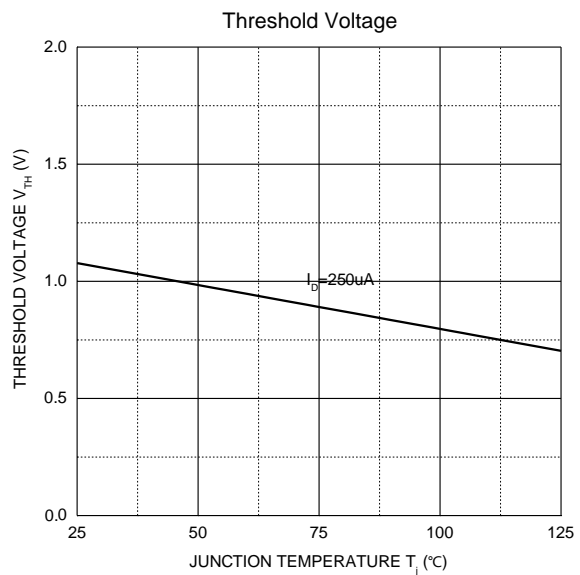
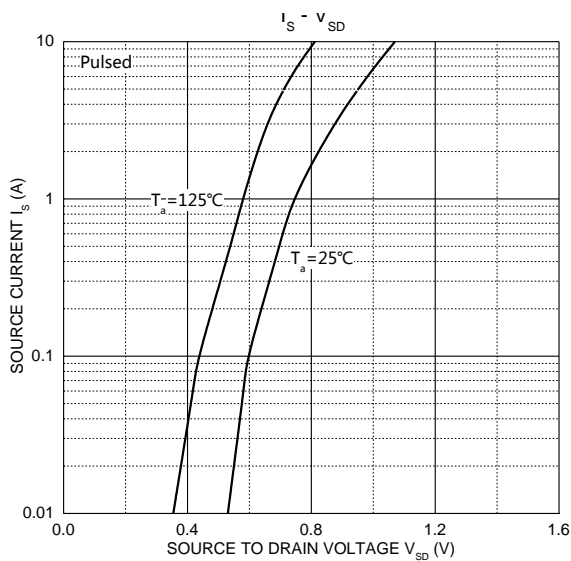
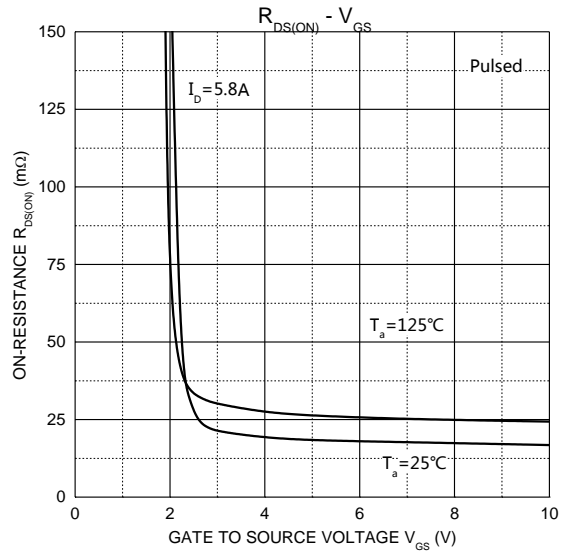
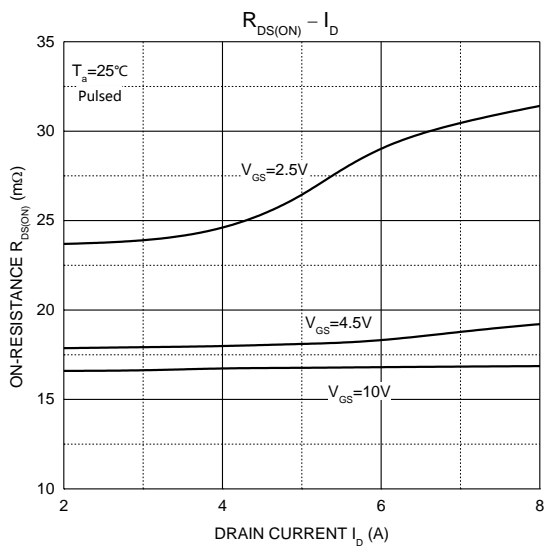
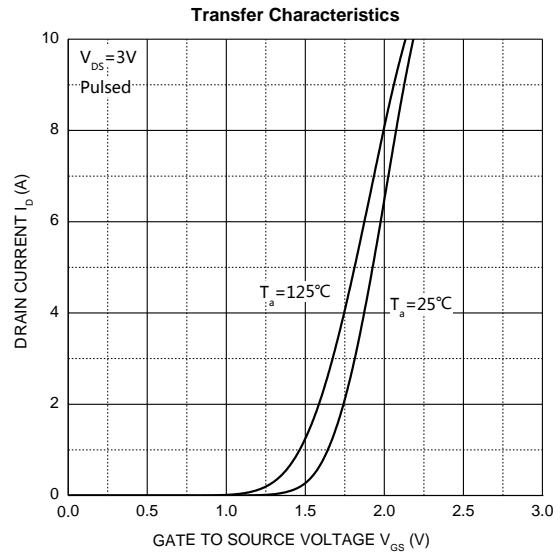
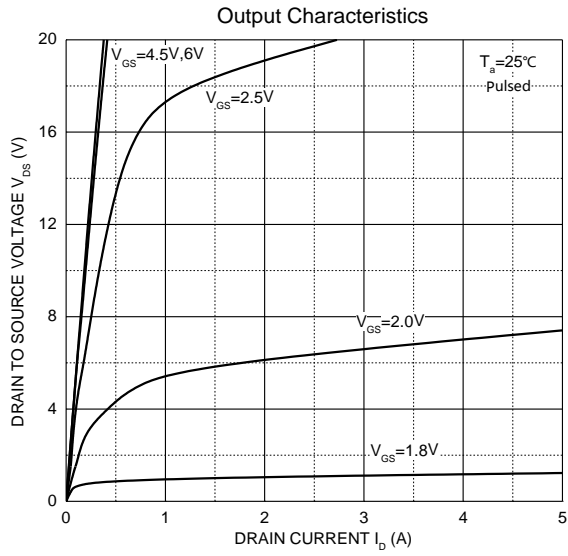

SOT-23-3L Package Information

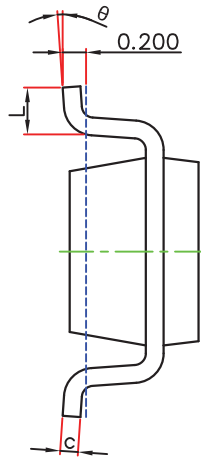
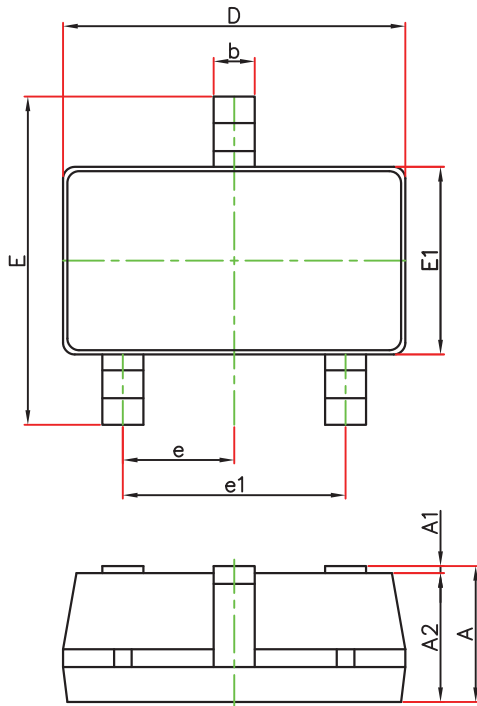

Symbol	Dimensions In Millimeters		Dimensions In Inches	
	Min.	Max.	Min.	Max.
A	1.050	1.250	0.041	0.049
A1	0.000	0.100	0.000	0.004
A2	1.050	1.150	0.041	0.045
b	0.300	0.500	0.012	0.020
c	0.100	0.200	0.004	0.008
D	2.820	3.020	0.111	0.119
E1	1.500	1.700	0.059	0.067
E	2.650	2.950	0.104	0.116
e	0.950(BSC)		0.037(BSC)	
e1	1.800	2.000	0.071	0.079
L	0.300	0.600	0.012	0.024
θ	0°	8°	0°	8°

SOT-23-3L Tape and Reel

SOT-23-3L Embossed Carrier Tape

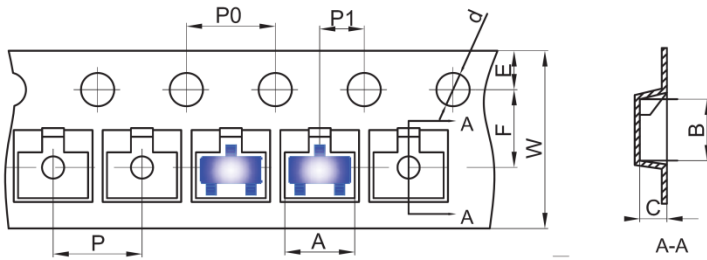

Dimensions are in millimeter											
Pkg type	A	B	C	d	E	F	P0	P	P1	W	
SOT-23-3L	3.18	3.28	1.32	Ø1.50	1.75	3.50	4.00	4.00	2.00	8.00	

SOT-23-3L Tape Leader and Trailer

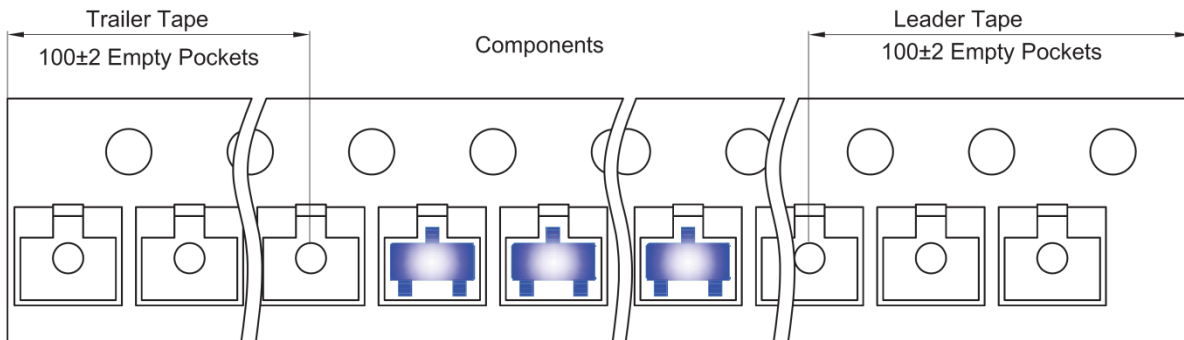

SOT-23-3L Reel

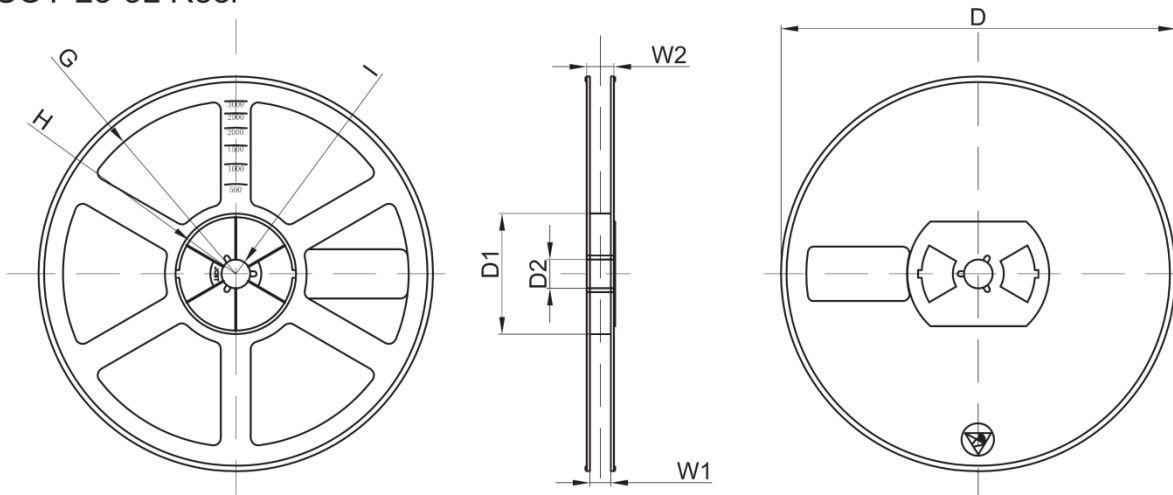

Dimensions are in millimeter								
Reel Option	D	D1	D2	G	H	I	W1	W2
7" Dia	Ø180.00	60.00	13.00	R78.00	R25.60	R6.50	9.50	13.10

REEL	Reel Size	Box	Box Size(mm)	Carton	Carton Size(mm)	G.W.(kg)
3000 pcs	7 inch	30,000 pcs	203×203×195	120,000 pcs	438×438×220	

单击下面可查看定价，库存，交付和生命周期等信息

[>>GP\(格瑞宝\)](#)