



Product Summary

$V_{(BR)DSS}$	$R_{DS(on)TYP}$	I_D
-30V	50mΩ@-10V	-4.2A
	60mΩ@-4.5V	
	70mΩ@-2.5V	

Feature

- TrenchFET Power MOSFET
- Exceptional on-resistance and maximum DC current capability

Application

- DC/DC Converter
- Load Switch for Portable Devices
- Battery Switch

MARKING:

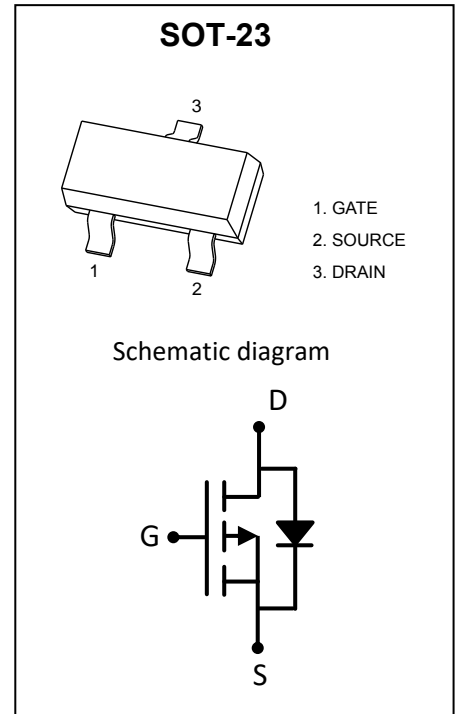
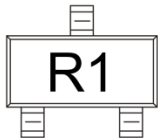

ABSOLUTE MAXIMUM RATINGS ($T_a=25^\circ\text{C}$ unless otherwise noted)

Parameter	Symbol	Value	Unit
Drain-Source Voltage	V_{DS}	-30	V
Gate-Source Voltage	V_{GS}	± 12	V
Continuous Drain Current	I_D	-4.2	A
Power Dissipation	P_D	0.35	W
Thermal Resistance from Junction to Ambient	$R_{\theta JA}$	357	$^\circ\text{C}/\text{W}$
Junction Temperature	T_J	150	$^\circ\text{C}$
Storage Temperature	T_{STG}	-55~ +150	$^\circ\text{C}$

MOSFET ELECTRICAL CHARACTERISTICS($T_a=25^{\circ}\text{C}$ unless otherwise noted)

Parameter	Symbol	Test Condition	Min	Type	Max	Unit
Static Characteristics						
Drain-source breakdown voltage	$V_{(BR)DSS}$	$V_{GS} = 0V, I_D = -250\mu A$	-30			V
Zero gate voltage drain current	I_{DSS}	$V_{DS} = -24V, V_{GS} = 0V$			-1	μA
Gate-body leakage current	I_{GSS}	$V_{GS} = \pm 12V, V_{DS} = 0V$			± 100	nA
Gate threshold voltage	$V_{GS(th)}$	$V_{DS} = V_{GS}, I_D = -250\mu A$	-0.7	-0.9	-1.3	V
Drain-source on-resistance ⁽¹⁾	$R_{DS(on)}$	$V_{GS} = -10V, I_D = -4.2A$		50	65	m Ω
		$V_{GS} = -4.5V, I_D = -4A$		60	75	
		$V_{GS} = -2.5V, I_D = -1A$		70	90	
Forward transconductance ⁽¹⁾	g_{FS}	$V_{DS} = -5V, I_D = -4.2A$		10		S
Dynamic characteristics⁽²⁾						
Input Capacitance	C_{iss}	$V_{DS} = -15V, V_{GS} = 0V, f = 1MHz$		954		pF
Output Capacitance	C_{oss}			115		
Reverse Transfer Capacitance	C_{rss}			77		
Switching characteristics⁽²⁾						
Turn-on delay time	$t_{d(on)}$	$V_{GS} = -10V, V_{DS} = -15V,$ $R_L = 3.6\Omega, R_{GEN} = 6\Omega$			6.3	ns
Turn-on rise time	t_r				3.2	
Turn-off delay time	$t_{d(off)}$				38.2	
Turn-off fall time	t_f				12	
Source-Drain Diode characteristics						
Diode forward current	I_S				-2	A
Diode pulsed forward current	I_{SM}				-25	A
Diode Forward voltage ⁽¹⁾	V_{DS}	$V_{GS} = 0V, I_S = -4.2A$			-1.2	V

Notes:

1. Pulse test; pulse width $\leq 300\mu s$, duty cycle $\leq 2\%$.
2. Guaranteed by design, not subject to production testing.

Typical Electrical and Thermal Characteristics

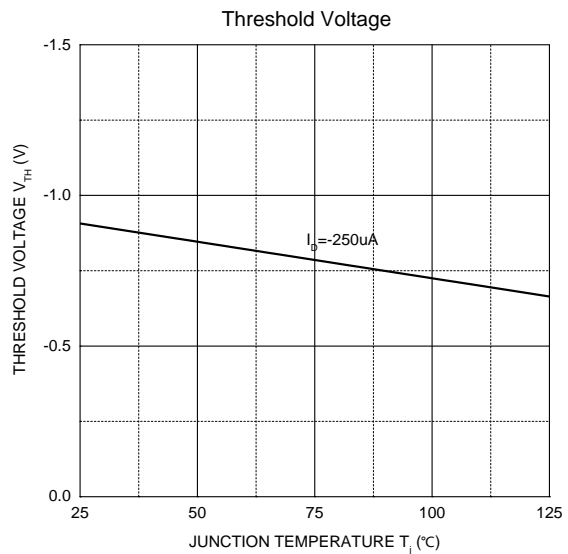
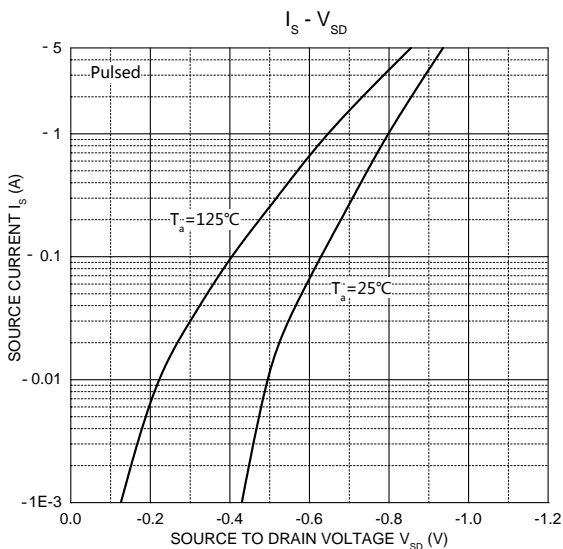
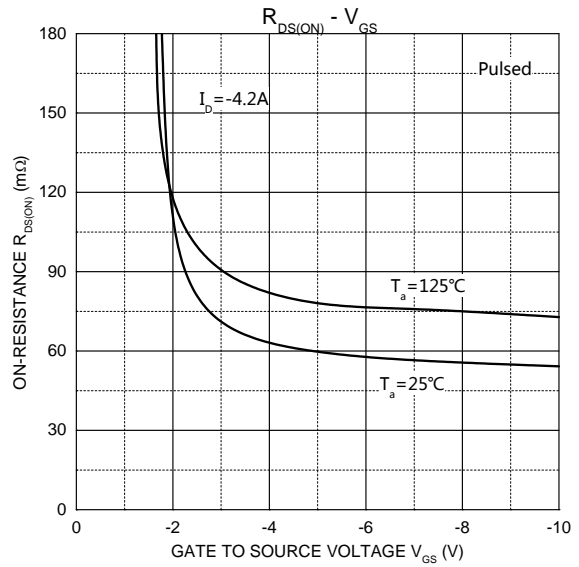
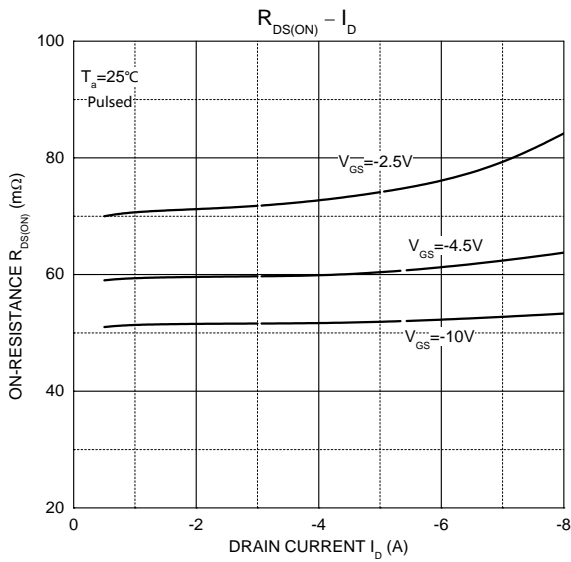
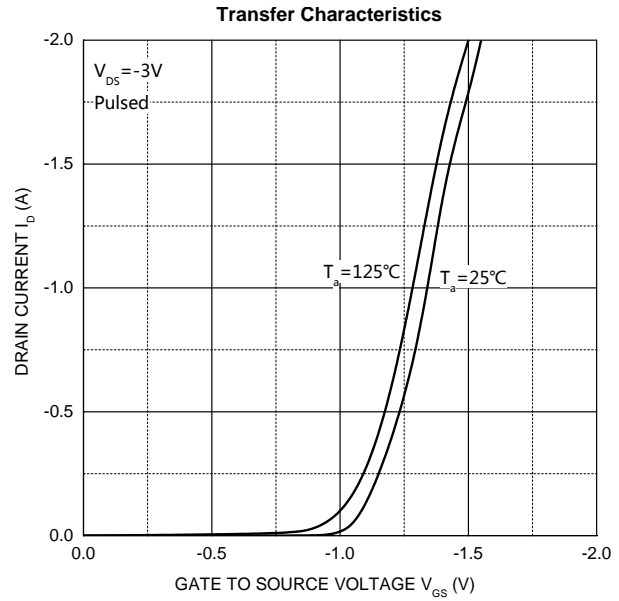
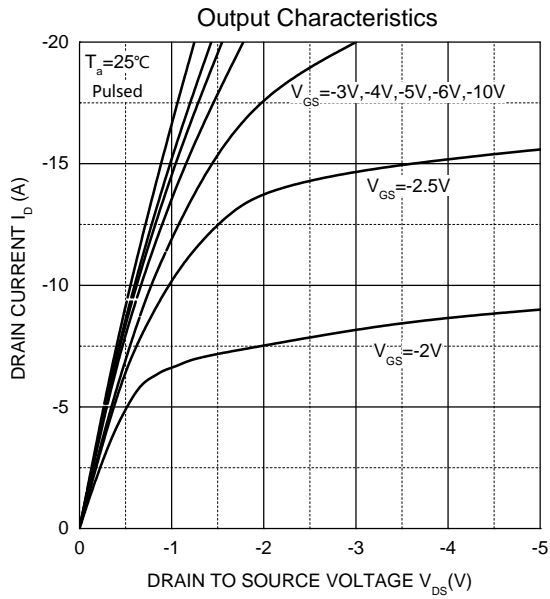

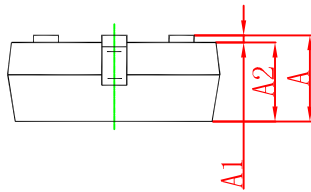
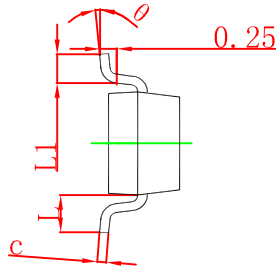
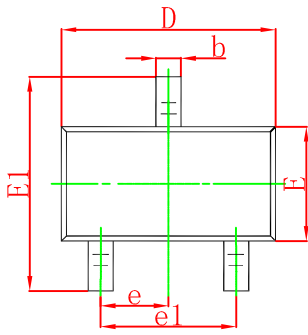
SOT-23 Package Information

Symbol	Dimensions In Millimeters		Dimensions In Inches	
	Min	Max	Min	Max
A	0.900	1.150	0.035	0.045
A1	0.000	0.100	0.000	0.004
A2	0.900	1.050	0.035	0.041
b	0.300	0.500	0.012	0.020
c	0.080	0.150	0.003	0.006
D	2.800	3.000	0.110	0.118
E	1.200	1.400	0.047	0.055
E1	2.250	2.550	0.089	0.100
e	0.950 TYP		0.037 TYP	
e1	1.800	2.000	0.071	0.079
L	0.550 REF		0.022 REF	
L1	0.300	0.500	0.012	0.020
θ	0°	8°	0°	8°

SOT-23 Tape and Reel

SOT-23 Tape and reel

SOT-23 Embossed Carrier Tape

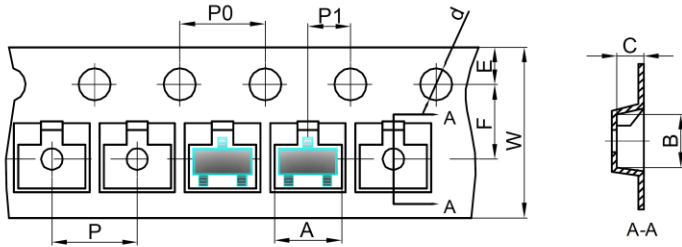

Dimensions are in millimeter										
Pkg type	A	B	C	d	E	F	P0	P	P1	W
SOT-23	3.15	2.77	1.22	Ø1.50	1.75	3.50	4.00	4.00	2.00	8.00

SOT-23 Tape Leader and Trailer

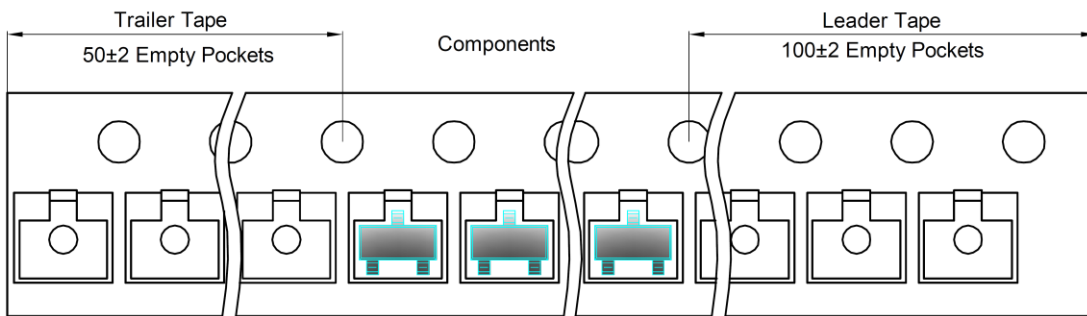

SOT-23 Reel

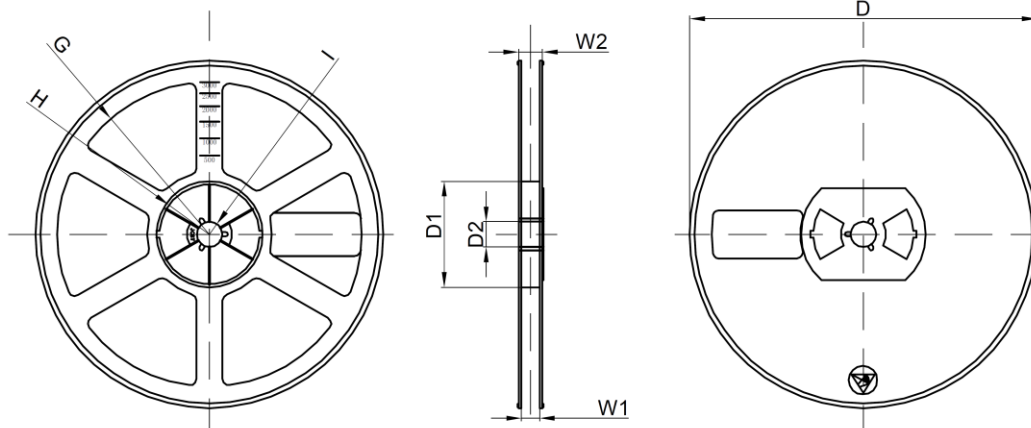

Dimensions are in millimeter								
Reel Option	D	D1	D2	G	H	I	W1	W2
7" Dia	Ø178.00	54.40	13.00	R78.00	R25.60	R6.50	9.50	12.30

REEL	Reel Size	Box	Box Size(mm)	Carton	Carton Size(mm)	G.W.(kg)
3000 pcs	7 inch	30,000 pcs	203×203×195	120,000 pcs	438×438×220	

单击下面可查看定价，库存，交付和生命周期等信息

[>>GP\(格瑞宝\)](#)