

### Product Summary

$V_{(BR)DSS}$	$R_{DS(on)TYP}$	$I_D$
-30V	45mΩ@-10V	-4.1A
	65mΩ@-4.5V	

### Feature

- Trench Power MOSFET
- Excellent  $R_{DS(on)}$
- Low Gate Charge

### Application

- Load Switch
- PWM Application

### MARKING:

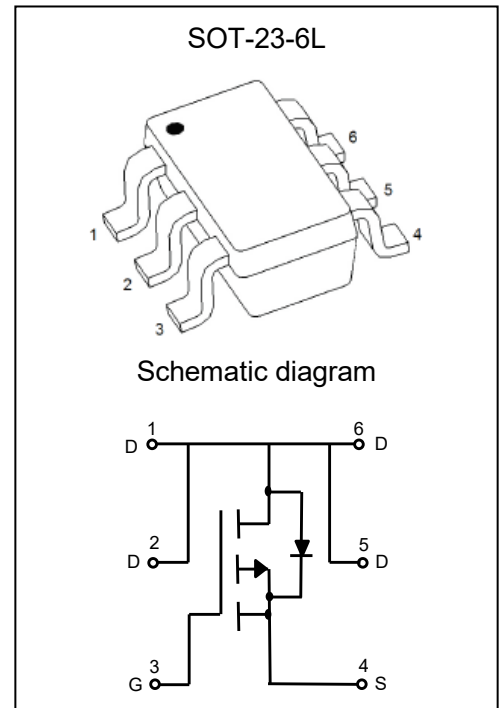
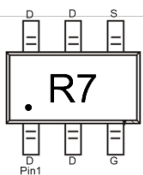

### ABSOLUTE MAXIMUM RATINGS ( $T_a=25^{\circ}\text{C}$ unless otherwise noted)

Parameter	Symbol	Value	Unit
Drain-Source Voltage	$V_{DS}$	-30	V
Gate-Source Voltage	$V_{GS}$	$\pm 20$	V
Continuous Drain Current	$I_D$	-4.1	A
Power Dissipation	$P_D$	0.35	W
Thermal Resistance from Junction to Ambient	$R_{\theta JA}$	357	$^{\circ}\text{C/W}$
Junction Temperature	$T_J$	150	$^{\circ}\text{C}$
Storage Temperature	$T_{STG}$	-55~ +150	$^{\circ}\text{C}$

**MOSFET ELECTRICAL CHARACTERISTICS(T<sub>a</sub>=25°C unless otherwise noted)**

Parameter	Symbol	Test Condition	Min	Type	Max	Unit
<b>Static Characteristics</b>						
Drain-source breakdown voltage	V <sub>(BR)DSS</sub>	V <sub>GS</sub> = 0V, I <sub>D</sub> = -250μA	-30			V
Zero gate voltage drain current	I <sub>DSS</sub>	V <sub>DS</sub> = -24V, V <sub>GS</sub> = 0V			-1	μA
Gate-body leakage current	I <sub>GSS</sub>	V <sub>GS</sub> = ±20V, V <sub>DS</sub> = 0V			±100	nA
Gate threshold voltage <sup>(1)</sup>	V <sub>GS(th)</sub>	V <sub>DS</sub> = V <sub>GS</sub> , I <sub>D</sub> = -250μA	-1	-1.4	-3	V
Drain-source on-resistance <sup>(1)</sup>	R <sub>DS(on)</sub>	V <sub>GS</sub> = -10V, I <sub>D</sub> = -4.1A		45	60	mΩ
		V <sub>GS</sub> = -4.5V, I <sub>D</sub> = -3A		65	87	
Forward tranconductance <sup>(1)</sup>	g <sub>FS</sub>	V <sub>DS</sub> = -5V, I <sub>D</sub> = -4A	5.5			S
Diode Forward voltage <sup>(1)</sup>	V <sub>DS</sub>	V <sub>GS</sub> = 0V, I <sub>S</sub> = -1.0A			-1	V
<b>Dynamic characteristics</b>						
Input Capacitance	C <sub>iss</sub>	V <sub>DS</sub> = -15V, V <sub>GS</sub> = 0V, f = 1MHz		550		pF
Output Capacitance	C <sub>oss</sub>			70		
Reverse Transfer Capacitance	C <sub>rss</sub>			60		
Total Gate Charge	Q <sub>g</sub>	V <sub>DS</sub> = -15V, V <sub>GS</sub> = -4.5V, I <sub>D</sub> = -3A		6		nC
Gate-Source Charge	Q <sub>gs</sub>			2		
Gate-Drain Charge	Q <sub>gd</sub>			1.7		
Turn-on delay time	t <sub>d(on)</sub>	V <sub>DD</sub> = -15V, V <sub>GS</sub> = -10V, R <sub>G</sub> = 3.3Ω, I <sub>D</sub> = -3A		2.7		ns
Turn-on rise time	t <sub>r</sub>			8.2		
Turn-off delay time	t <sub>d(off)</sub>			35		
Turn-off fall time	t <sub>f</sub>			5		

**Notes:**

1. Pulse test; pulse width ≤ 300μs, duty cycle ≤ 2%

Typical Electrical and Thermal Characteristics

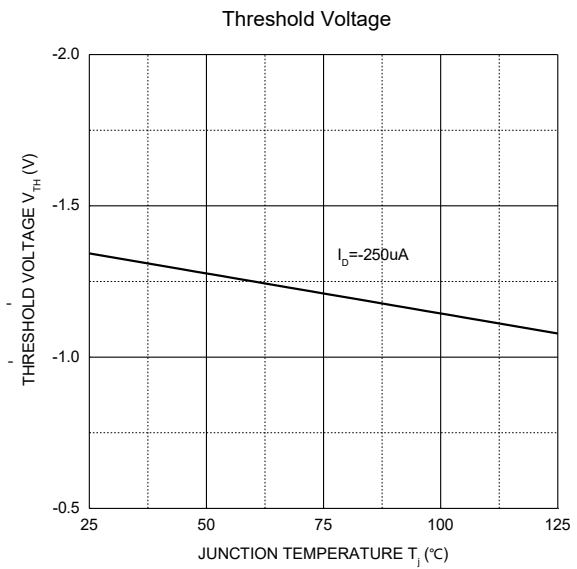
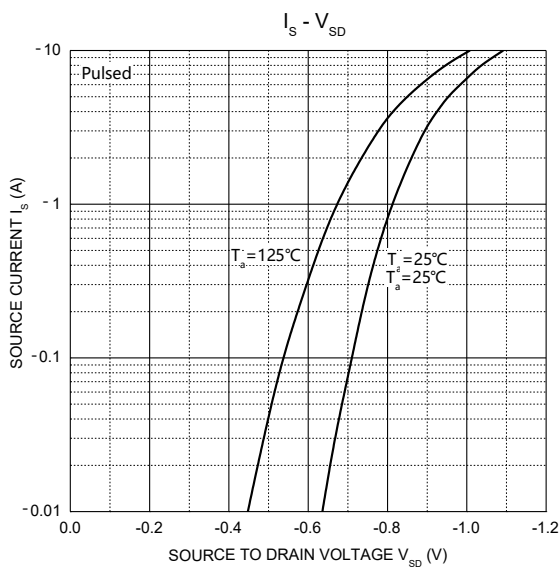
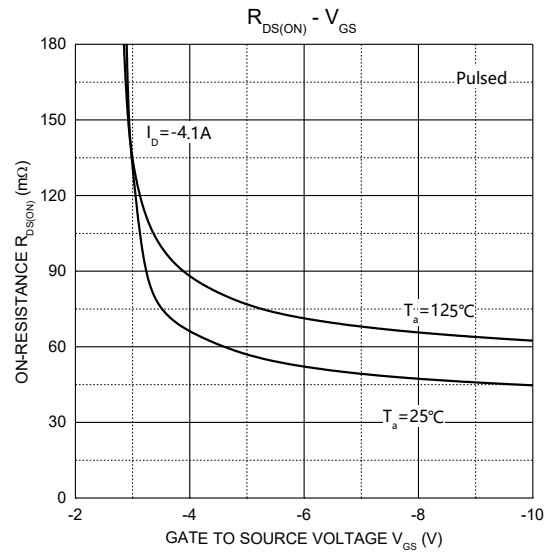
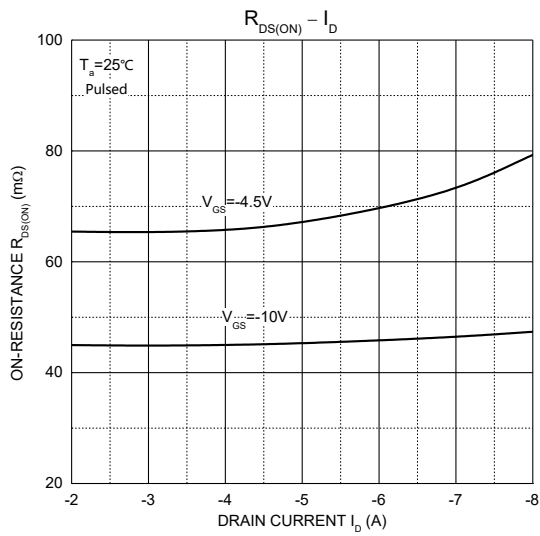
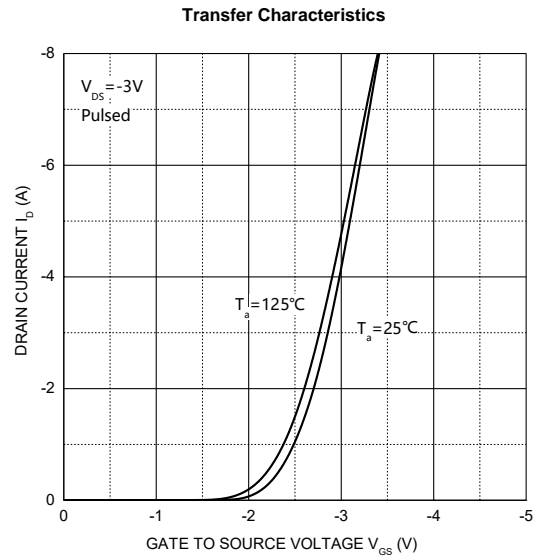
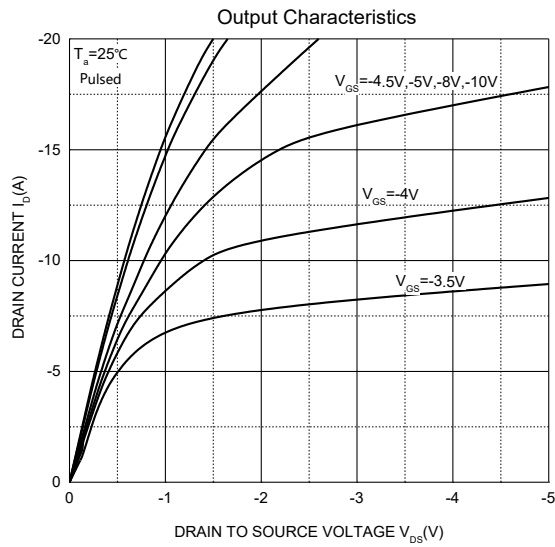

## SOT-23-6L Package Information

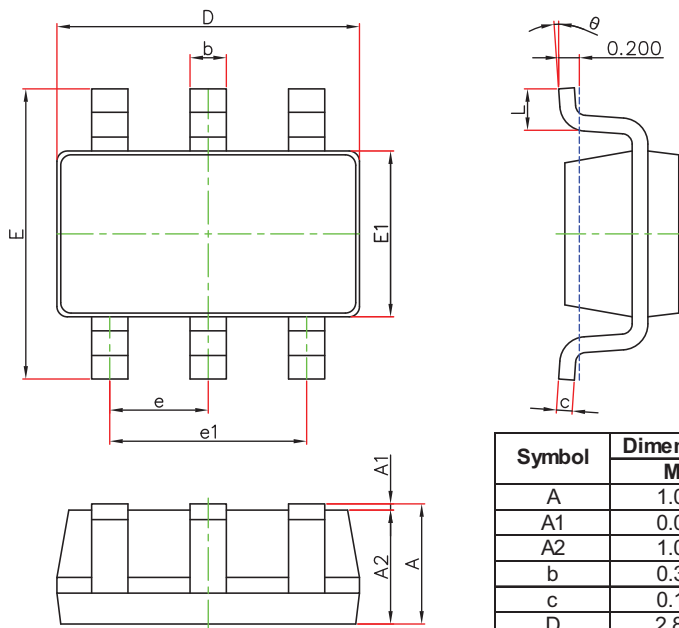

Symbol	Dimensions In Millimeters		Dimensions In Inches	
	Min.	Max.	Min.	Max.
A	1.050	1.250	0.041	0.049
A1	0.000	0.100	0.000	0.004
A2	1.050	1.150	0.041	0.045
b	0.300	0.500	0.012	0.020
c	0.100	0.200	0.004	0.008
D	2.820	3.020	0.111	0.119
E1	1.500	1.700	0.059	0.067
E	2.650	2.950	0.104	0.116
e	0.950(BSC)		0.037(BSC)	
e1	1.800	2.000	0.071	0.079
L	0.300	0.600	0.012	0.024
θ	0°	8°	0°	8°

## SOT-23-6L Tape and Reel

### SOT-23-6L Tape and Reel

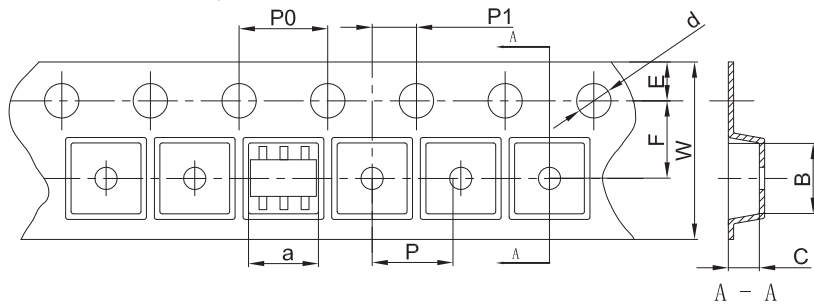

Dimensions are in millimeter										
Pkg type	a	B	C	d	E	F	P0	P	P1	W
SOT-23-6L	3.17	3.23	1.37	Ø1.55	1.75	3.50	4.00	4.00	2.00	8.00

### SOT-23-6L Tape Leader and Trailer

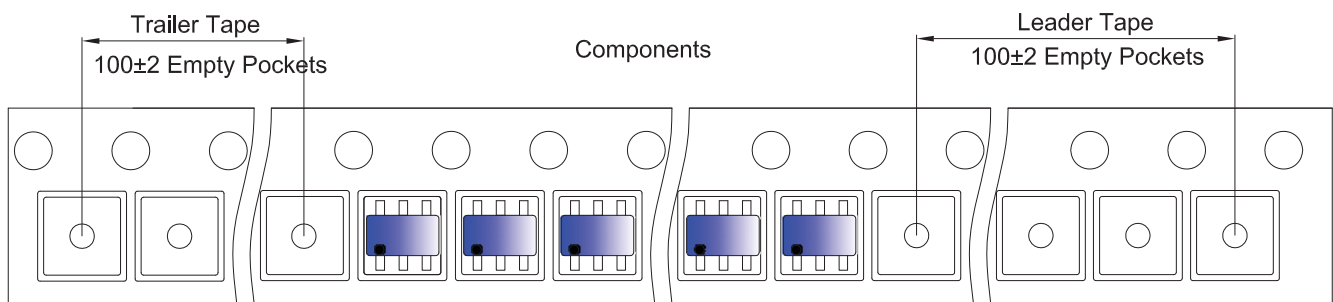

### SOT-23-6L Reel

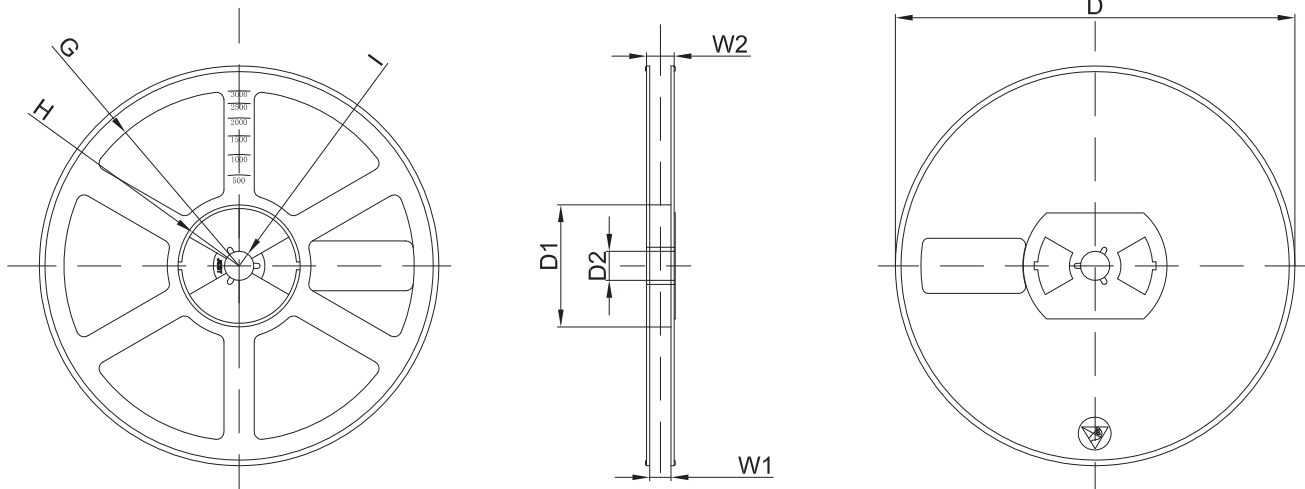

Dimensions are in millimeter								
Reel Option	D	D1	D2	G	H	I	W1	W2
7" Dia	Ø180.00	60.00	13.00	R78.00	R25.60	R6.50	9.50	13.10

REEL	Reel Size	Box	Box Size(mm)	Carton	Carton Size(mm)	G.W.(kg)
3000 pcs	7 inch	30,000 pcs	203×203×195	120,000 pcs	438×438×220	

单击下面可查看定价，库存，交付和生命周期等信息

[>>GP\(格瑞宝\)](#)