



Product Summary

$V_{(BR)DSS}$	$R_{DS(on)TYP}$	I_D
20V	17mΩ@10V	6A
	18mΩ@4.5V	
	22mΩ@2.5V	
	30mΩ@1.8V	

DESCRIPTION

The GP3420 uses advanced trench technology to provide excellent $R_{DS(on)}$. This device is suitable for use as a uni-directional or bi-directional load switch.

MARKING:

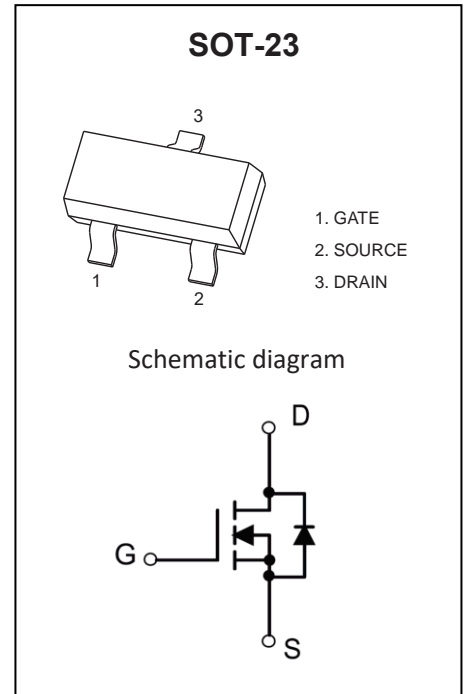
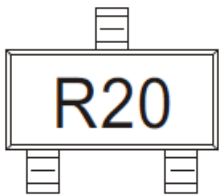

ABSOLUTE MAXIMUM RATINGS ($T_a=25^\circ\text{C}$ unless otherwise noted)

Parameter	Symbol	Value	Unit
Drain-Source Voltage	V_{DS}	20	V
Gate-Source Voltage	V_{GS}	± 12	V
Continuous Drain Current	I_D	6	A
Pulsed Drain Current	I_{DM}	25	
Continuous Source-Drain Diode Current	I_S	2.0	
Power Dissipation	P_D	0.35	W
Thermal Resistance from Junction to Ambient	$R_{\theta JA}$	357	$^\circ\text{C}/\text{W}$
Junction Temperature	T_J	150	$^\circ\text{C}$
Storage Temperature	T_{STG}	-55~ +150	

MOSFET ELECTRICAL CHARACTERISTICS($T_a=25^{\circ}\text{C}$ unless otherwise noted)

Parameter	Symbol	Test Condition	Min	Type	Max	Unit
Static Characteristics						
Drain-source breakdown voltage	$V_{(BR)DSS}$	$V_{GS} = 0V, I_D = 250\mu A$	20			V
Zero gate voltage drain current	I_{DSS}	$V_{DS} = 16V, V_{GS} = 0V$			1	μA
Gate-body leakage current	I_{GSS}	$V_{GS} = \pm 12V, V_{DS} = 0V$			± 100	nA
Gate threshold voltage	$V_{GS(th)}$	$V_{DS} = V_{GS}, I_D = 250\mu A$	0.5	0.7	1.0	V
Drain-source on-resistance	$R_{DS(on)}$	$V_{GS} = 10V, I_D = 5.0A$		17	22	m Ω
		$V_{GS} = 4.5V, I_D = 5.0A$		18	24	
		$V_{GS} = 2.5V, I_D = 4.7A$		22	32	
		$V_{GS} = 1.8V, I_D = 4.3A$		30	45	
Forward transconductance	g_{FS}	$V_{DS} = 5V, I_D = 3.8A$	4			S
Diode Forward voltage	V_{DS}	$V_{GS} = 0V, I_S = 1A$			1	V
Dynamic characteristics*						
Input Capacitance	C_{iss}	$V_{DS} = 10V, V_{GS} = 0V, f = 1MHz$		630		pF
Output Capacitance	C_{oss}			164		
Reverse Transfer Capacitance	C_{rss}			137		
Gate resistance	R_g	$f = 1MHz$		1.5		Ω
Switching Characteristics*						
Turn-on delay time	$t_{d(on)}$	$V_{GS} = 5V, V_{DS} = 10V,$ $R_L = 1.7\Omega, R_{GEN} = 6\Omega$		5.5		ns
Turn-on rise time	t_r			14		
Turn-off delay time	$t_{d(off)}$			29		
Turn-off fall time	t_f			10.2		

*These parameters have no way to verify.

Typical Electrical and Thermal Characteristics

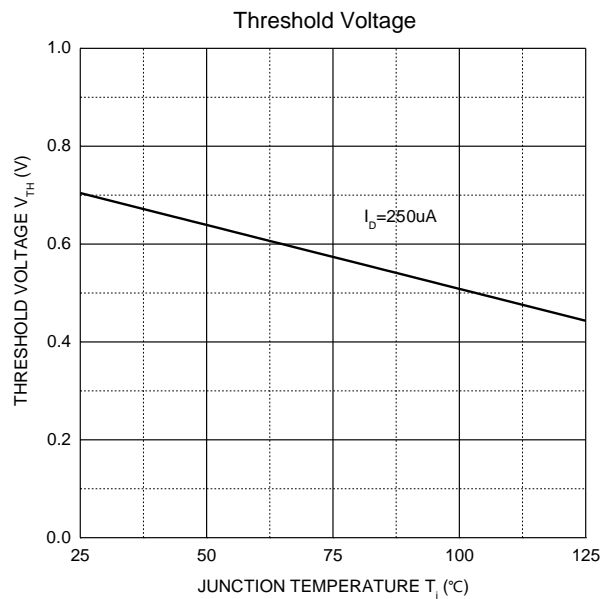
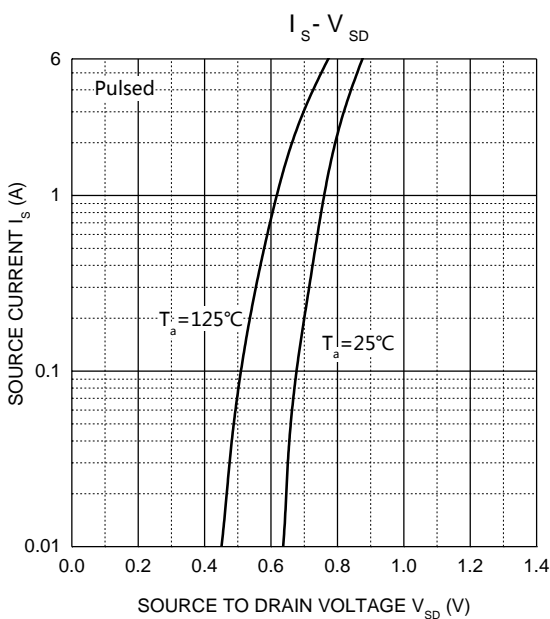
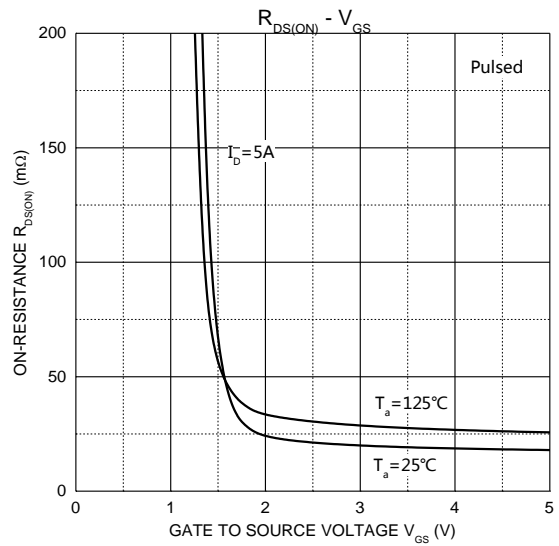
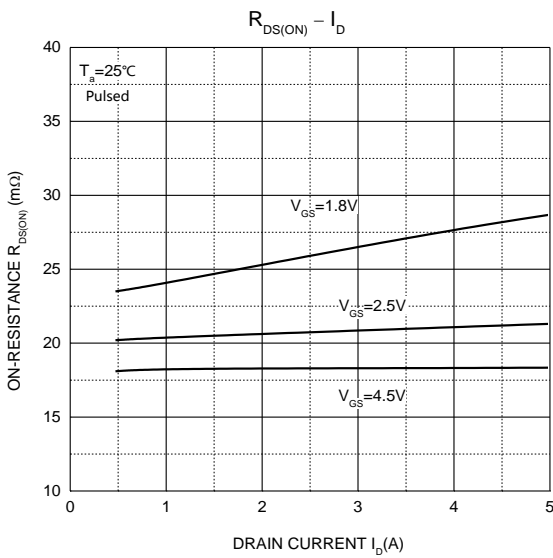
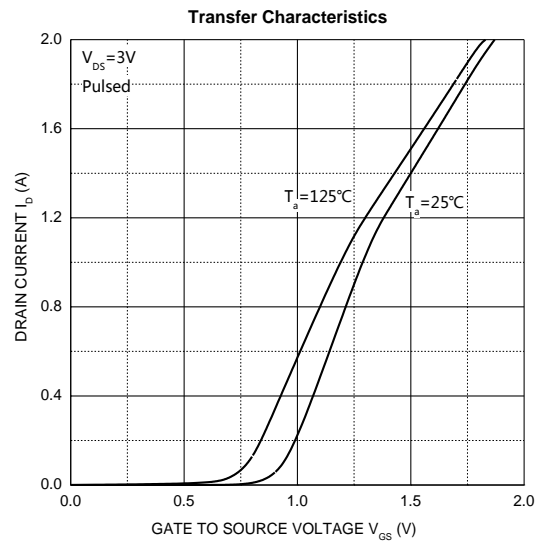
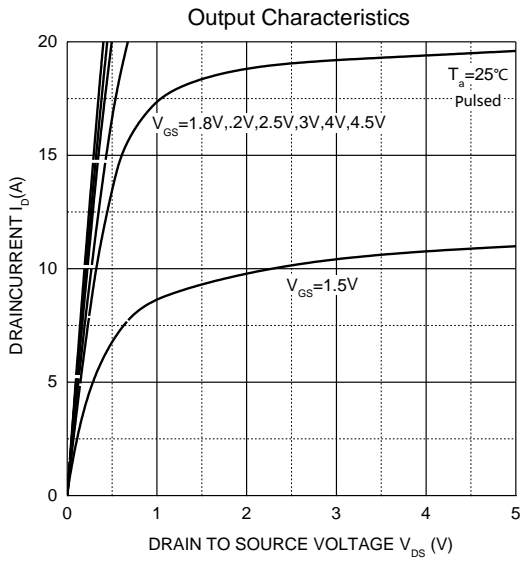

SOT-23 Package Information

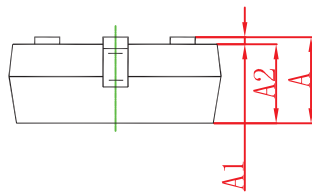
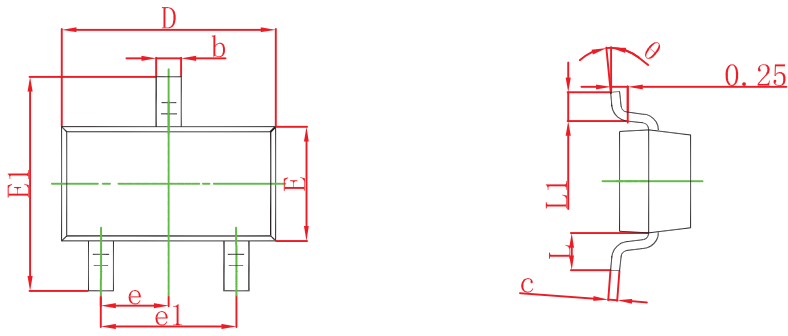

Symbol	Dimensions In Millimeters		Dimensions In Inches	
	Min	Max	Min	Max
A	0.900	1.150	0.035	0.045
A1	0.000	0.100	0.000	0.004
A2	0.900	1.050	0.035	0.041
b	0.300	0.500	0.012	0.020
c	0.080	0.150	0.003	0.006
D	2.800	3.000	0.110	0.118
E	1.200	1.400	0.047	0.055
E1	2.250	2.550	0.089	0.100
e	0.950 TYP		0.037 TYP	
e1	1.800	2.000	0.071	0.079
L	0.550 REF		0.022 REF	
L1	0.300	0.500	0.012	0.020
θ	0°	8°	0°	8°

SOT-23 Tape and Reel

SOT-23 Tape and reel

SOT-23 Embossed Carrier Tape

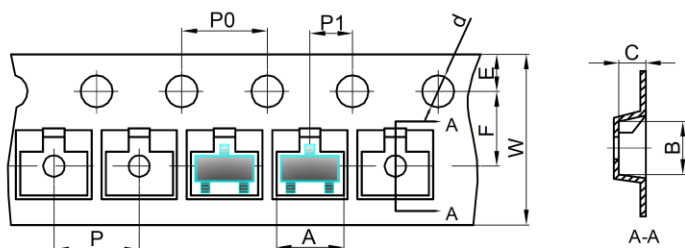

Dimensions are in millimeter										
Pkg type	A	B	C	d	E	F	P0	P	P1	W
SOT-23	3.15	2.77	1.22	Ø1.50	1.75	3.50	4.00	4.00	2.00	8.00

SOT-23 Tape Leader and Trailer

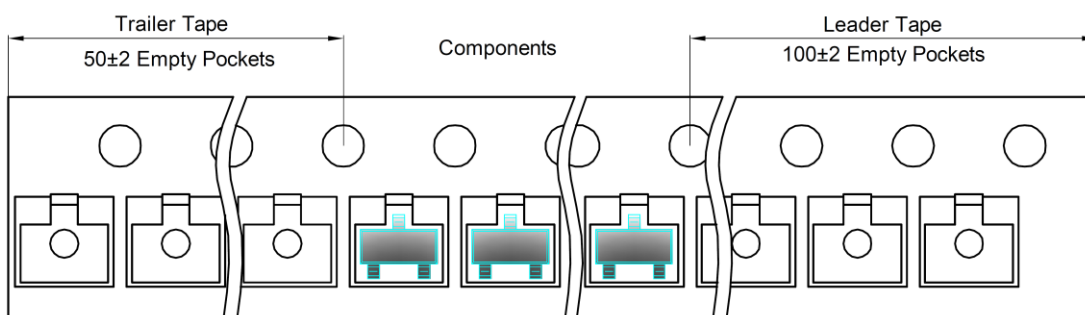

SOT-23 Reel

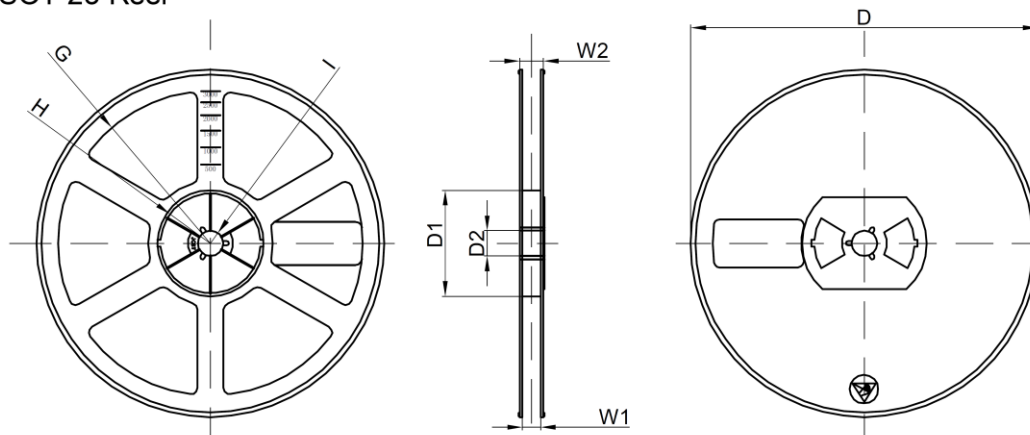

Dimensions are in millimeter								
Reel Option	D	D1	D2	G	H	I	W1	W2
7" Dia	Ø178.00	54.40	13.00	R78.00	R25.60	R6.50	9.50	12.30

REEL	Reel Size	Box	Box Size(mm)	Carton	Carton Size(mm)	G.W.(kg)
3000 pcs	7 inch	30,000 pcs	203×203×195	120,000 pcs	438×438×220	

单击下面可查看定价，库存，交付和生命周期等信息

[>>GP\(格瑞宝\)](#)