

Product Summary

$V_{(BR)DSS}$	$R_{DS(on)TYP}$	I_D
20V	270mΩ@4.5V	0.75A
	320mΩ@2.5V	
	415mΩ@1.8V	

Feature

- Lead Free Product is Acquired
- Surface Mount Package
- N-Channel Switch with Low $R_{DS(on)}$
- Operated at Low Logic Level Gate Drive

Application

- Load/Power Switching
- Interfacing Switching
- Battery Management for Ultra Small Portable Electronics
- Logic Level Shift

MARKING:

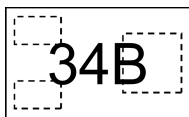

Top View

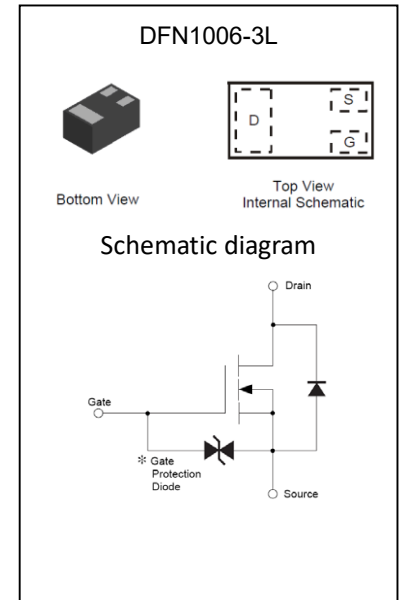

ABSOLUTE MAXIMUM RATINGS ($T_a=25^\circ\text{C}$ unless otherwise noted)

Parameter	Symbol	Value	Unit
Drain-Source Voltage	V_{DS}	20	V
Gate-Source Voltage	V_{GS}	± 12	V
Continuous Drain Current ⁽¹⁾	I_D	0.75	A
Pulsed Drain Current($t_p=10\mu\text{s}$)	I_{DM}	1.8	A
Power Dissipation ⁽¹⁾	P_D	100	mW
Thermal Resistance from Junction to Ambient ⁽¹⁾	$R_{\theta JA}$	1250	$^\circ\text{C/W}$
Junction Temperature	T_J	150	$^\circ\text{C}$
Storage Temperature	T_{STG}	-55~ +150	$^\circ\text{C}$
Lead Temperature for Soldering Purposes(1/8" from case for 10s)	T_L	260	$^\circ\text{C}$

MOSFET ELECTRICAL CHARACTERISTICS(T_a=25°C unless otherwise noted)

Parameter	Symbol	Test Condition	Min	Type	Max	Unit
Static Characteristics						
Drain-source breakdown voltage	V _{(BR)DSS}	V _{GS} = 0V, I _D =250μA	20			V
Zero gate voltage drain current	I _{DSS}	V _{DS} =20V, V _{GS} = 0V			1	μA
Gate-body leakage current	I _{GSS}	V _{GS} =±10V, V _{DS} = 0V			±20	μA
Gate threshold voltage ⁽²⁾	V _{GS(th)}	V _{DS} =V _{GS} , I _D =250μA	0.35	0.75	1.0	V
Drain-source on-resistance ⁽²⁾	R _{DS(on)}	V _{GS} =4.5V, I _D =150mA		270	370	mΩ
		V _{GS} =2.5V, I _D =150mA		320	480	
		V _{GS} =1.8V, I _D =150mA		415	620	
Forward tranconductance	g _{FS}	V _{DS} =10V, I _D =150mA	150			mS
Dynamic characteristics⁽⁴⁾						
Input Capacitance	C _{iss}	V _{DS} =16V, V _{GS} =0V, f=1MHz		79		pF
Output Capacitance	C _{oss}			13		
Reverse Transfer Capacitance	C _{rss}			9		
Switching Characteristics⁽⁴⁾						
Turn-on delay time ⁽³⁾	t _{d(on)}	V _{DS} =10V, I _D =500mA, V _{GS} =4.5V, R _G =10Ω		6.7		ns
Turn-on rise time ⁽³⁾	t _r			4.8		
Turn-off delay time ⁽³⁾	t _{d(off)}			17.3		
Turn-off fall time ⁽³⁾	t _f			7.4		
Source-Drain Diode characteristics						
Diode Forward voltage ⁽³⁾	V _{DS}	I _S =0.15A, V _{GS} = 0V			1.2	V

Notes:

1. Surface mounted on FR4 board using the minimum recommended pad size.
2. Pulse Test : Pulse Width=300μs, Duty Cycle=2%.
3. Switching characteristics are independent of operating junction temperatures.
4. Guaranteed by design, not subject to producing.

Typical Electrical and Thermal Characteristics

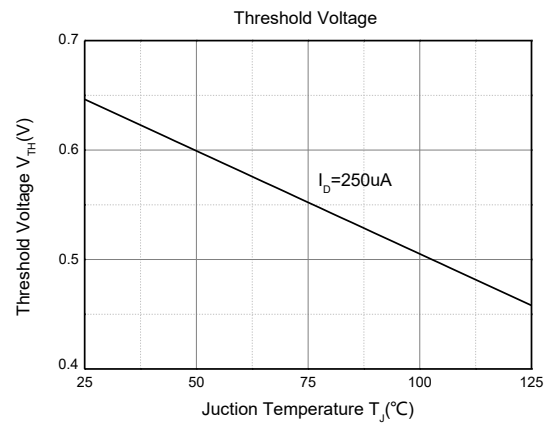
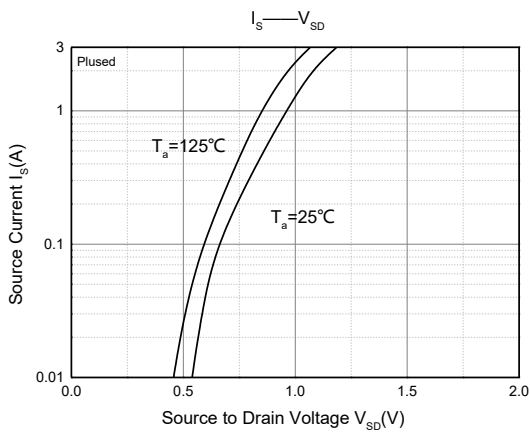
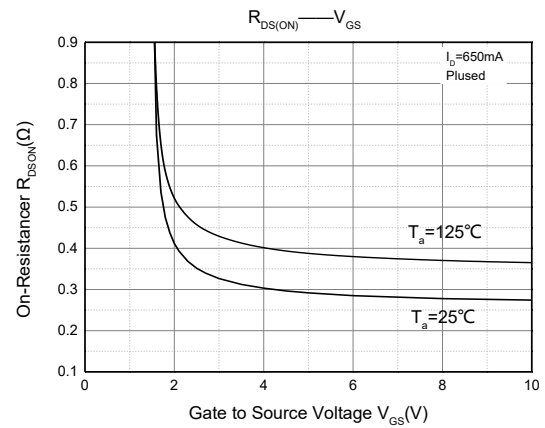
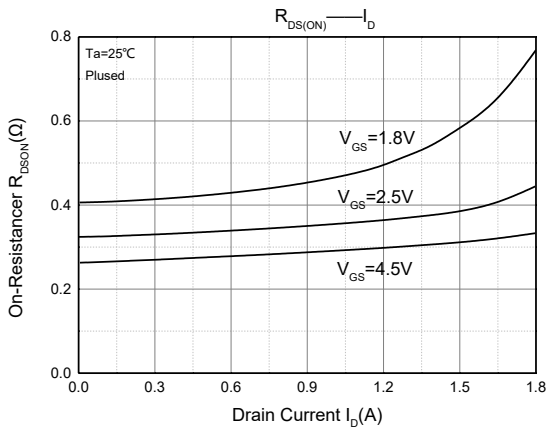
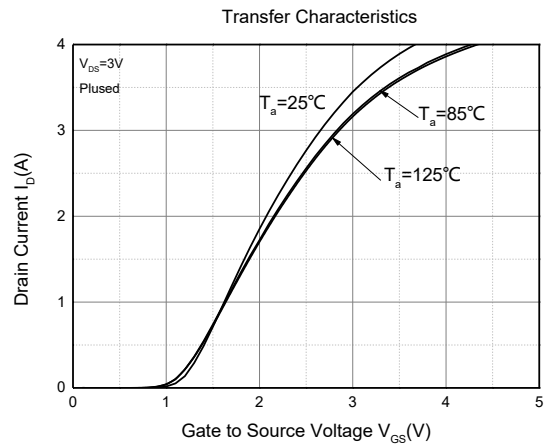
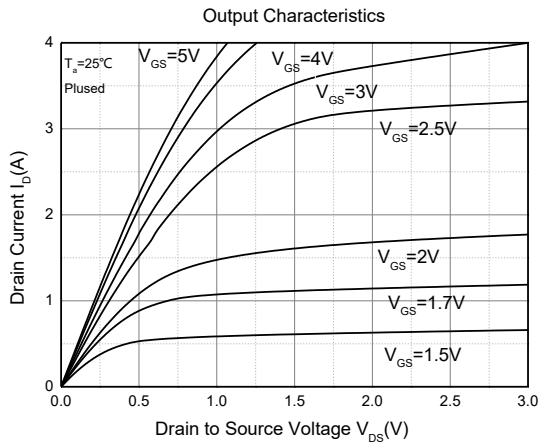

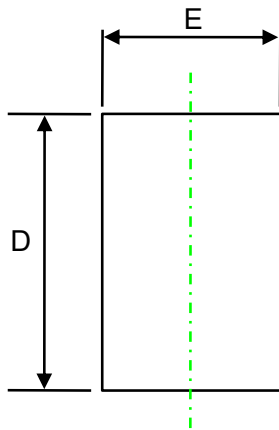
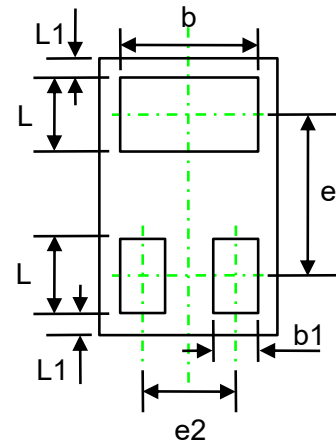
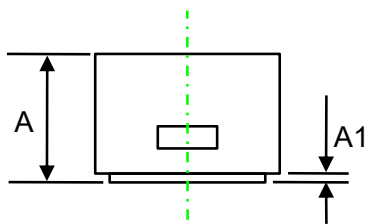
DFN1006-3L Package Information

TOP VIEW

BOTTOM VIEW

SIDE VIEW

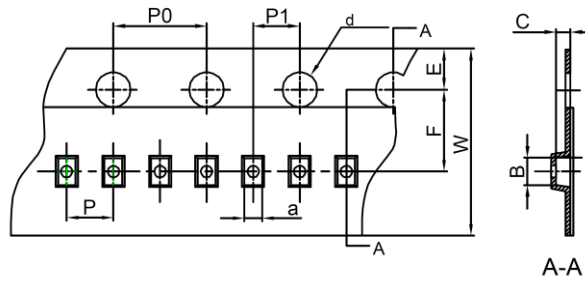
Symbol	Dimensions In Millimeters (mm)		
	Min.	Typ.	Max.
A	0.34	0.37	0.40
A1	0.00	0.03	0.05
D	0.95	1.00	1.05
E	0.55	0.60	0.65
b	0.45	0.50	0.55
e	-	0.65	-
e2	-	0.35	-
L1	0.05 REF.		
L	0.20	0.25	0.30
b1	0.10	0.15	0.20

DFN1006-3L Tape and Reel

DFN1006-3L Embossed Carrier Tape



Dimensions are in millimeter										
Pkg type	a	B	C	d	E	F	P0	P	P1	W
DFN1006-3L	0.66	1.15	0.66	Ø1.50	1.75	3.50	4.00	2.00	2.00	8.00

DFN1006-3L Tape Leader and Trailer

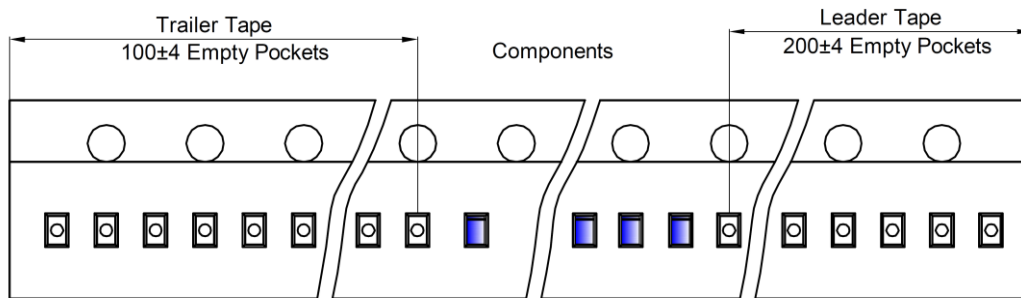

DFN1006-3L Reel

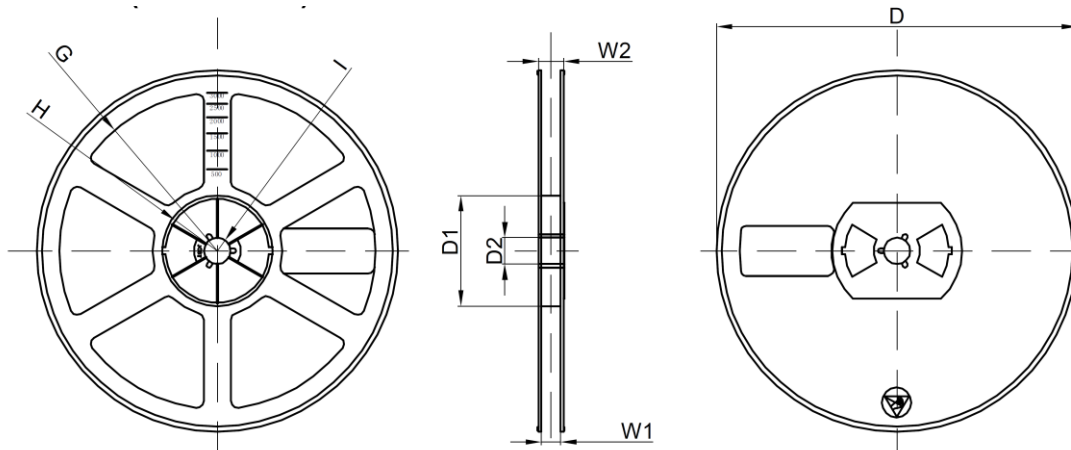

Dimensions are in millimeter								
Reel Option	D	D1	D2	G	H	I	W1	W2
7" Dia	Ø178.00	54.40	13.00	R78.00	R25.60	R6.50	9.50	12.30

REEL	Reel Size	Box	Box Size(mm)	Carton	Carton Size(mm)	G.W.(kg)
10000 pcs	7 inch	100,000 pcs	203×203×195	400,000 pcs	438×438×220	

单击下面可查看定价，库存，交付和生命周期等信息

[>>GP\(格瑞宝\)](#)