

Product Summary

$V_{(BR)DSS}$	$R_{DS(on)TYP}$	I_D
30V	15mΩ@10V	8A
	20mΩ@4.5V	

Feature

- TrenchFET Power MOSFET
- Excellent $R_{DS(on)}$
- Low Gate Charge

Application

- Load Switch for Portable Devices
- Battery Switch

MARKING:

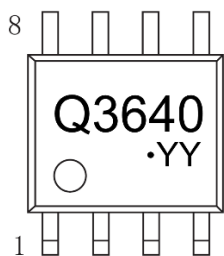

Q3640 = Device code
 YY = Date Code
 Solid dot = Pin1 indicator
 Solid dot = Green molding compound device,
 If none, the normal device.

SOP-8

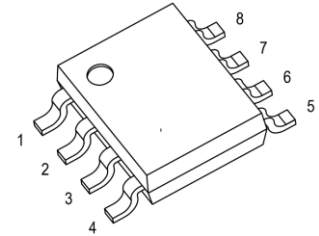

Schematic diagram

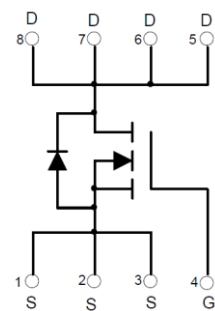

ABSOLUTE MAXIMUM RATINGS ($T_a=25^{\circ}C$ unless otherwise noted)

Parameter	Symbol	Value	Unit
Drain-Source Voltage	V_{DS}	30	V
Gate-Source Voltage	V_{GS}	±20	V
Continuous Drain Current	I_D	8	A
Pulsed Drain Current	I_{DM}	24	A
Power Dissipation	P_D	1.4	W
Thermal Resistance from Junction to Ambient($t \leq 10s$)	$R_{\theta JA}$	89	$^{\circ}C/W$
Junction Temperature	T_J	150	$^{\circ}C$
Storage Temperature	T_{STG}	-55~ +150	$^{\circ}C$

MOSFET ELECTRICAL CHARACTERISTICS (T_a=25°C unless otherwise noted)

Parameter	Symbol	Test Condition	Min	Type	Max	Unit
Static Characteristics						
Drain-source breakdown voltage	V _{(BR)DSS}	V _{GS} = 0V, I _D = 250μA	30			V
Zero gate voltage drain current	I _{DSS}	V _{DS} = 30V, V _{GS} = 0V			1	μA
Gate-body leakage current	I _{GSS}	V _{GS} = ±20V, V _{DS} = 0V			±0.1	μA
On characteristics⁽¹⁾						
Gate threshold voltage	V _{GS(th)}	V _{DS} = V _{GS} , I _D = 250μA	1	1.4	2.5	V
Drain-source on-resistance	R _{DS(on)}	V _{GS} = 10V, I _D = 8A		15	19	mΩ
		V _{GS} = 4.5V, I _D = 4A		20	27	
Dynamic characteristics⁽²⁾						
Input capacitance	C _{iss}	V _{DS} = 15V, V _{GS} = 0V, f = 1MHz		980		pF
Output capacitance	C _{oss}			100		
Reverse transfer capacitance	C _{rss}			85		
Switching characteristics⁽²⁾						
Total gate charge	Q _g	V _{DS} = 15V, V _{GS} = 10V, I _D = 8A		25		nC
Gate-source charge	Q _{gs}			7		
Gate-drain charge	Q _{gd}			9		
Turn-on delay time	t _{d(on)}	V _{DD} = 15V, I _D = 8A, R _G = 3.0Ω V _{GS} = 10V		14		ns
Turn-on rise time	t _r			20		
Turn-off delay time	t _{d(off)}			35		
Turn-off fall time	t _f			13		
Drain-Source Diode Characteristics						
Drain-source diode forward voltage ⁽¹⁾	V _{SD}	V _{GS} = 0V, I _S = 8A			1.2	V
Continuous drain-source diode forward current	I _S				8	A
Pulsed drain-source diode forward current	I _{SM}				24	

Notes:

1. Pulse test; pulse width ≤ 300μs, duty cycle ≤ 2%.
2. Guaranteed by design, not subject to production testing.

Typical Electrical and Thermal Characteristics

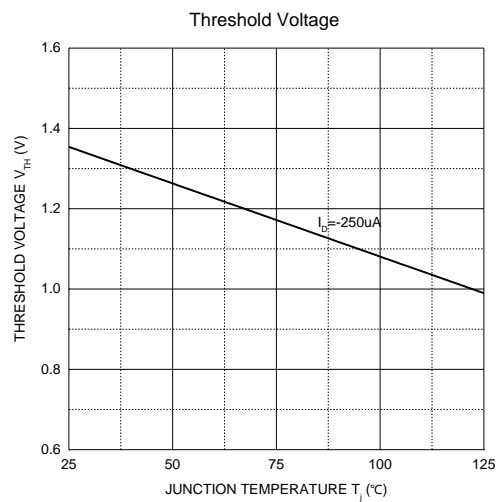
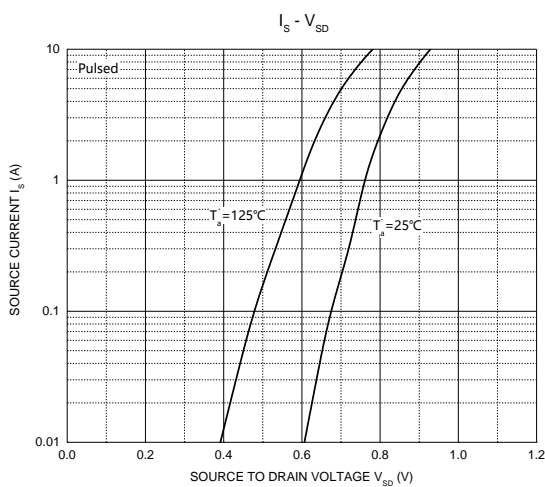
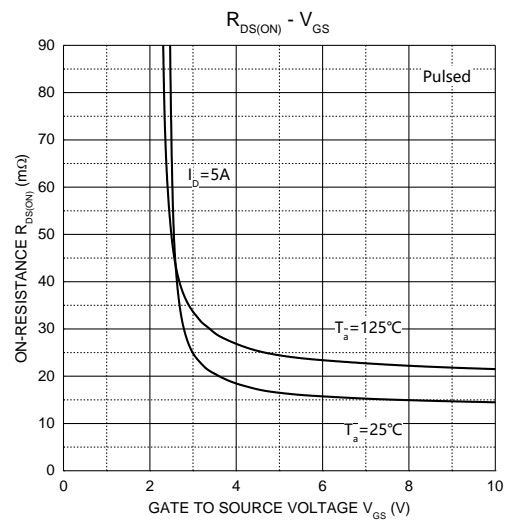
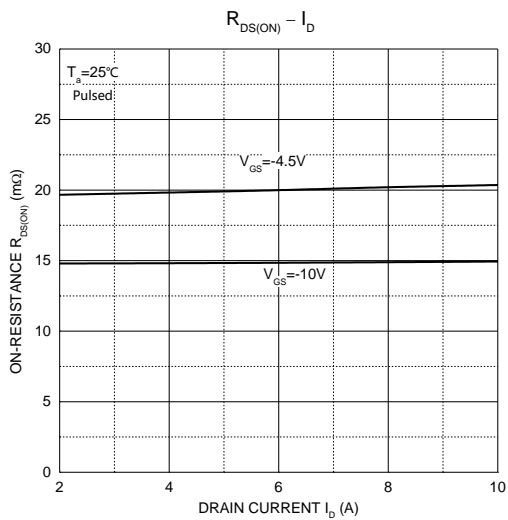
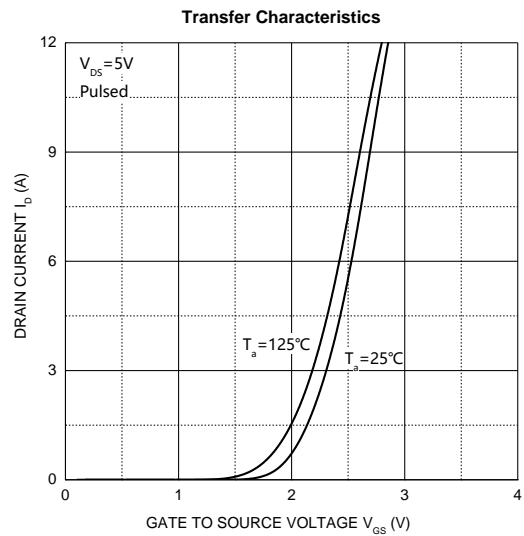
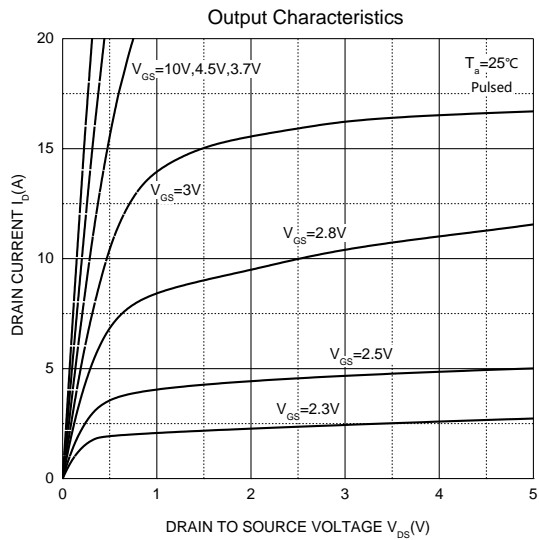

SOP-8 Package Information

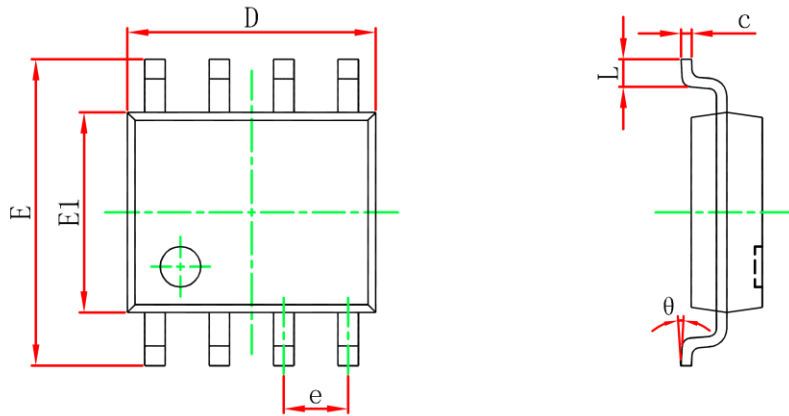

Symbol	Dimensions In Millimeters		Dimensions In Inches	
	Min	Max	Min	Max
A	1.350	1.750	0.053	0.069
A1	0.100	0.250	0.004	0.010
A2	1.350	1.550	0.053	0.061
b	0.330	0.510	0.013	0.020
c	0.170	0.250	0.007	0.010
D	4.800	5.000	0.189	0.197
e	1.270 (BSC)		0.050 (BSC)	
E	5.800	6.200	0.228	0.244
E1	3.800	4.000	0.150	0.157
L	0.400	1.270	0.016	0.050
θ	0°	8°	0°	8°

SOP-8 Package Information

SOP8 Embossed Carrier Tape

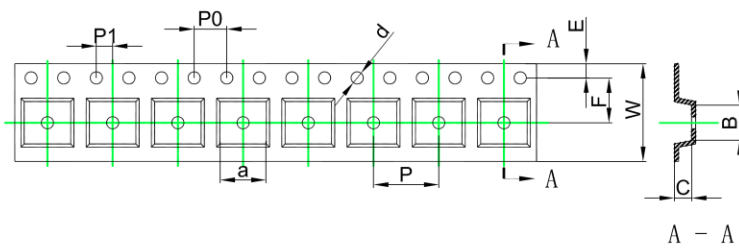

Dimensions are in millimeter

Pkg type	a	B	C	d	E	F	P0	P	P1	W
SOP8	6.40	5.40	2.10	Ø1.50	1.75	5.50	4.00	8.00	2.00	12.00

SOP8 Tape Leader and Trailer

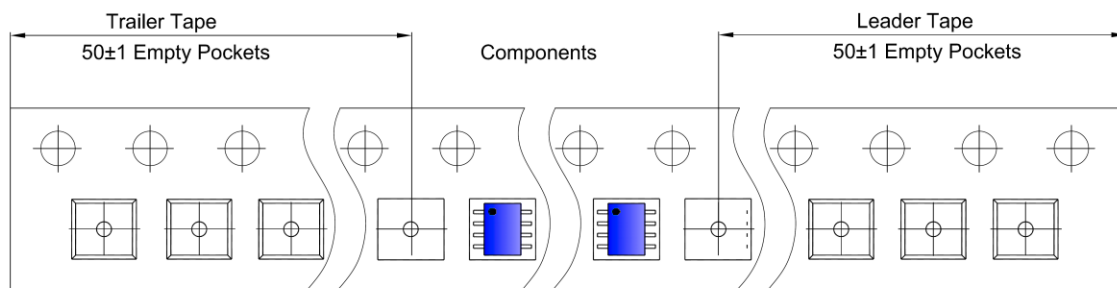

SOP8 Reel

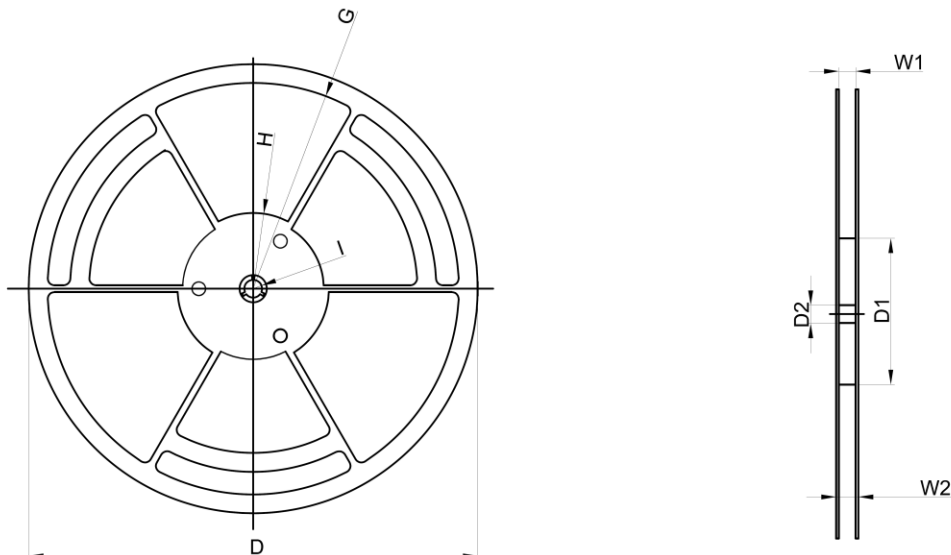

Dimensions are in millimeter

Reel Option	D	D1	D2	G	H	I	W1	W2
13" Dia	Ø330.00	100.00	13.00	R151.00	R56.00	R6.50	12.40	17.60

REEL	Reel Size	Box	Box Size(mm)	Carton	Carton Size(mm)	G.W.(kg)
4,000 pcs	13 inch	8,000 pcs	360×360×65	64,000 pcs	565×380×390	

单击下面可查看定价，库存，交付和生命周期等信息

[>>GP\(格瑞宝\)](#)