



Product Summary

$V_{(BR)DSS}$	$R_{DS(on)TYP}$	I_D
-20V	430mΩ@-4.5V	-0.66A
	620mΩ@-2.5V	
	950mΩ@-1.8V	

Feature

- Surface Mount Package
- P-Channel Switch with Low $R_{DS(on)}$
- Operated at Low Logic Level Gate Drive
- ESD Protected

Application

- Load/Power Switching
- Interfacing, Logic Switching
- Battery Management for Ultra Small Portable Electronics

WBFBP-03E

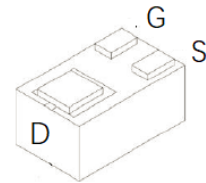

Schematic diagram

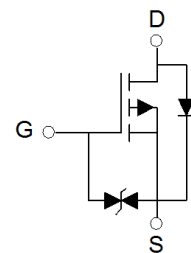

MARKING:



ABSOLUTE MAXIMUM RATINGS ($T_a=25^\circ\text{C}$ unless otherwise noted)

Parameter	Symbol	Value	Unit
Drain-Source Voltage	V_{DS}	-20	V
Gate-Source Voltage	V_{GS}	± 12	V
Continuous Drain Current ⁽¹⁾	I_D	-0.66	A
Pulsed Drain Current ($t_p=10\mu\text{s}$)	I_{DM}	-1.2	A
Power Dissipation ⁽¹⁾	P_D	100	mW
Thermal Resistance from Junction to Ambient ⁽¹⁾	$R_{\theta JA}$	1250	$^\circ\text{C/W}$
Junction Temperature	T_J	150	$^\circ\text{C}$
Storage Temperature	T_{STG}	-55~ +150	
Lead Temperature for Soldering Purposes(1/8" from case for 10s)	T_L	260	

MOSFET ELECTRICAL CHARACTERISTICS(T_a=25°C unless otherwise noted)

Parameter	Symbol	Test Condition	Min	Type	Max	Unit
Static Characteristics						
Drain-source breakdown voltage	V _{(BR)DSS}	V _{GS} = 0V, I _D = -250μA	-20			V
Zero gate voltage drain current	I _{DSS}	V _{DS} = -20V, V _{GS} = 0V			-1	μA
Gate-body leakage current	I _{GSS}	V _{GS} = ±10V, V _{DS} = 0V			±20	μA
Gate threshold voltage ⁽²⁾	V _{GS(th)}	V _{DS} = V _{GS} , I _D = -250μA	-0.35		-1.1	V
Drain-source on-resistance ⁽²⁾	R _{DS(on)}	V _{GS} = -4.5V, I _D = -0.1A		430	560	mΩ
		V _{GS} = -2.5V, I _D = -0.1A		620	800	
		V _{GS} = -1.8V, I _D = -0.1A		950		
Forward tranconductance ⁽²⁾	g _{FS}	V _{DS} = -10V, I _D = -0.54A	0.5			S
Dynamic characteristics⁽⁴⁾						
Input Capacitance	C _{iss}	V _{DS} = -16V, V _{GS} = 0V, f = 1MHz		74		pF
Output Capacitance	C _{oss}			16		
Reverse Transfer Capacitance	C _{rss}			12		
Switching Characteristics⁽⁴⁾						
Turn-on delay time ⁽³⁾	t _{d(on)}	V _{DS} = -10V, I _D = -200mA, V _{GS} = -4.5V, R _G = 10Ω		9		ns
Turn-on rise time ⁽³⁾	t _r			5.7		
Turn-off delay time ⁽³⁾	t _{d(off)}			32.6		
Turn-off fall time ⁽³⁾	t _f			20.3		
Source-Drain Diode characteristics						
Diode forward voltage	V _{DS}	I _S = -0.1A, V _{GS} = 0V		-0.79	-1.2	V

Notes:

- 1.Surface mounted on FR4 board using the minimum recommended pad size.
- 2.Pulse Test : Pulse Width=300μs, Duty Cycle=2%.
- 3.Switching characteristics are independent of operating junction temperatures.
- 4.Guaranteed by design, not subject to producing.

Typical Electrical and Thermal Characteristics

Output Characteristics

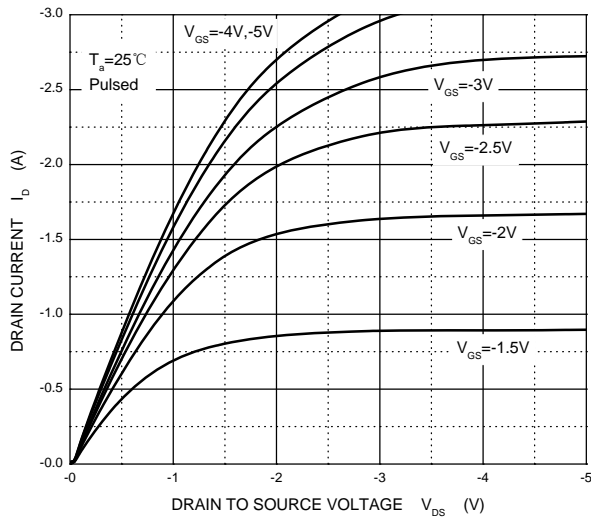

Transfer Characteristics

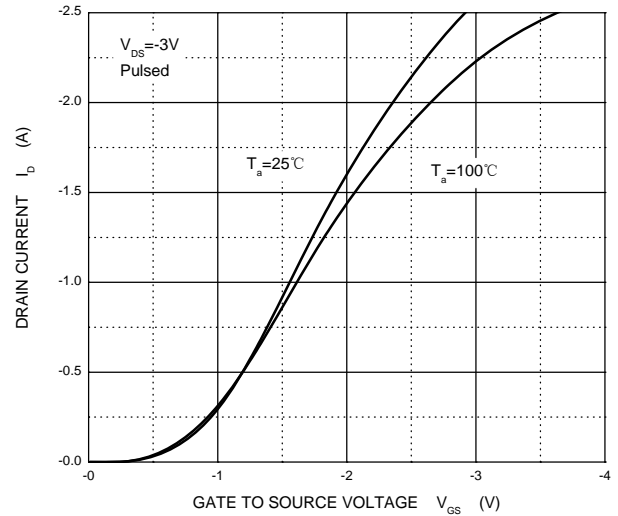

$R_{DS(ON)}$ — I_D

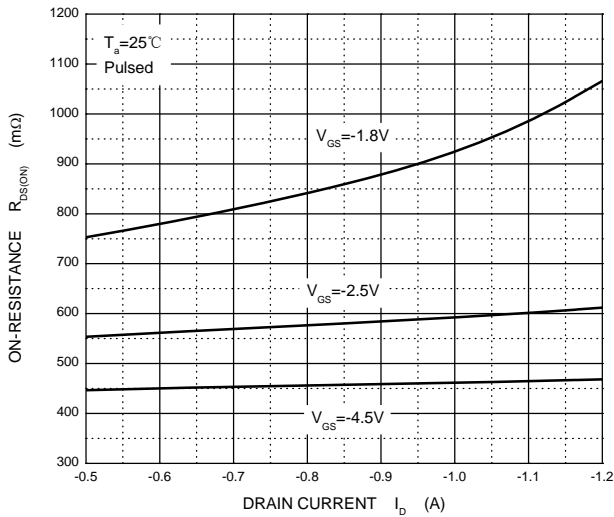

$R_{DS(ON)}$ — V_{GS}

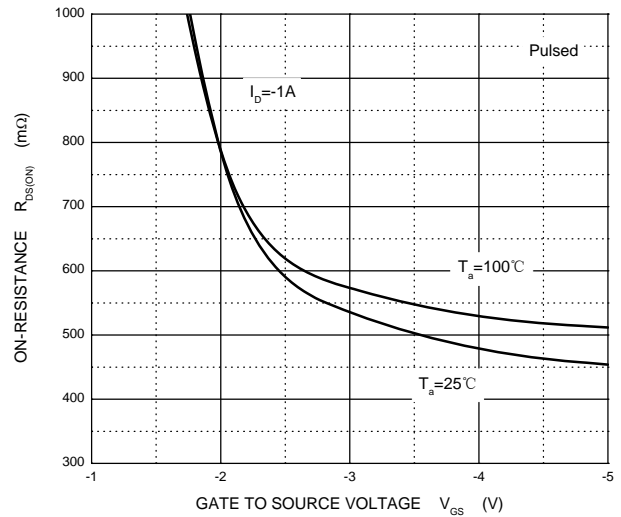

I_S — V_{SD}

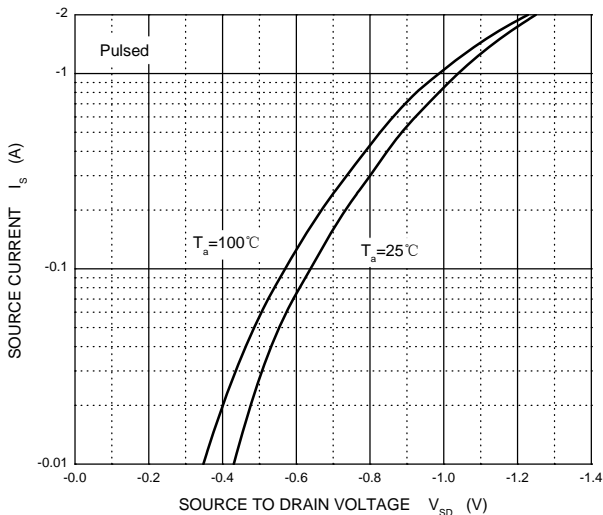

Threshold Voltage

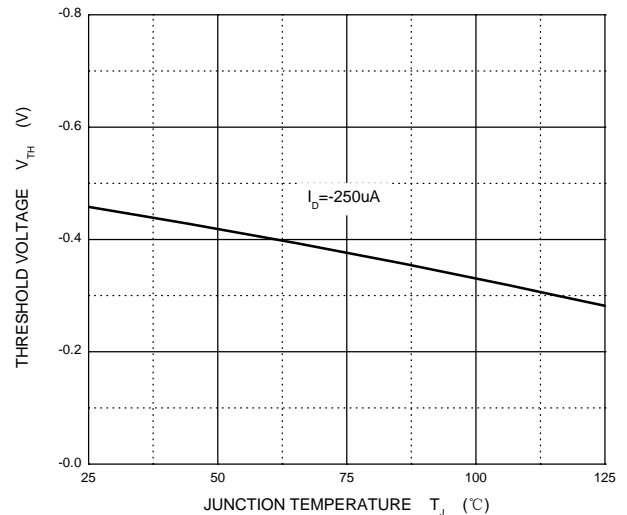

WBFBP-03E Package Information

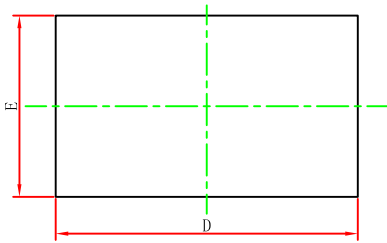

TOP VIEW

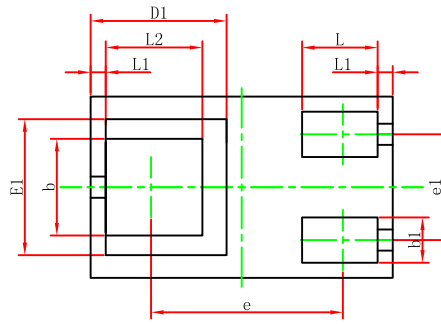

BOTTOM VIEW

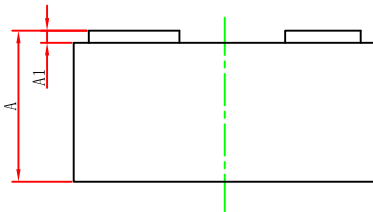

SIDE VIEW

Symbol	Dimensions In Millimeters		Dimensions In Inches	
	Min.	Max.	Min.	Max.
A	0.450	0.550	0.018	0.022
A1	0.010	0.100	0.000	0.004
D	0.950	1.050	0.037	0.041
E	0.550	0.650	0.022	0.026
D1	0.450REF.		0.018REF.	
E1	0.450REF.		0.018REF.	
b	0.270	0.370	0.011	0.015
b1	0.100	0.200	0.004	0.008
e	0.635REF.		0.025REF.	
e1	0.300	0.400	0.012	0.016
L	0.200	0.300	0.008	0.012
L1	0.050REF.		0.002REF.	
L2	0.270	0.370	0.011	0.015

WBFBP-03E Tape and Reel

WBFBP-03E(1.0×0.6×0.5) Embossed Carrier Tape

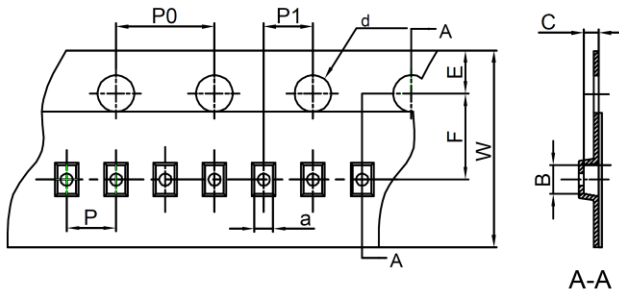

Dimensions are in millimeter										
Pkg type	a	B	C	d	E	F	P0	P	P1	W
WBFBP-03E (1.0×0.6×0.5)	0.66	1.15	0.66	Ø1.50	1.75	3.50	4.00	2.00	2.00	8.00

WBFBP-03E(1.0×0.6×0.5) Tape Leader and Trailer

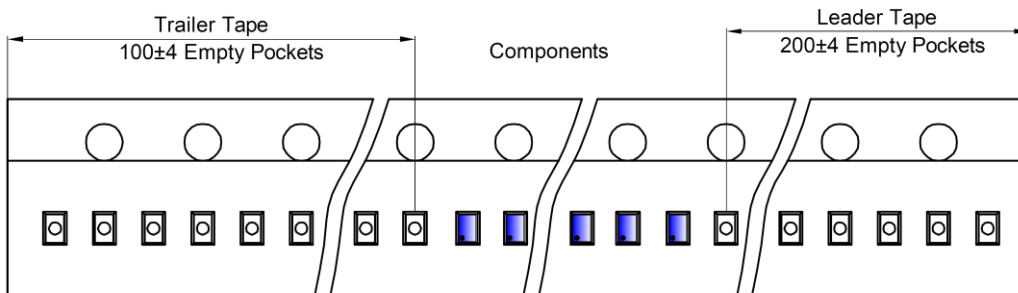

WBFBP-03E(1.0×0.6×0.5) Reel

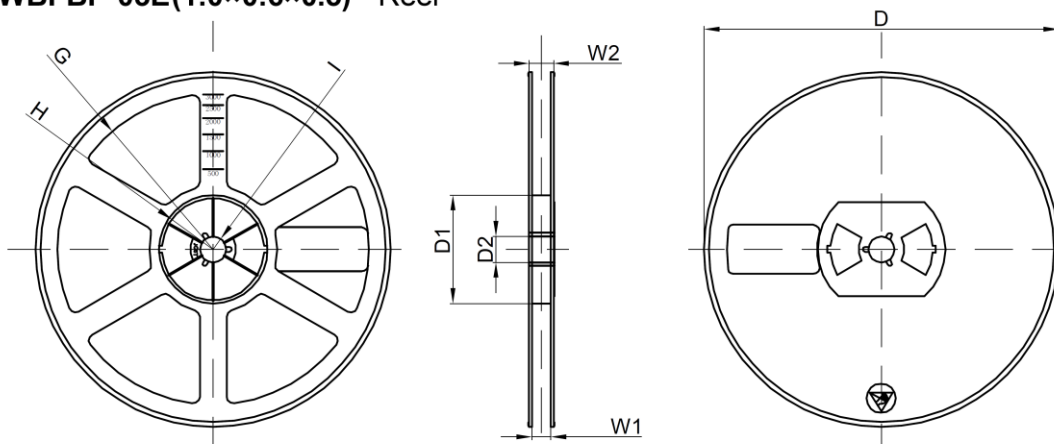

Dimensions are in millimeter								
Reel Option	D	D1	D2	G	H	I	W1	W2
7" Dia	Ø178.00	54.40	13.00	R78.00	R25.60	R6.50	9.50	12.30

REEL	Reel Size	Box	Box Size(mm)	Carton	Carton Size(mm)	G.W.(kg)
10000 pcs	7 inch	100,000 pcs	203×203×195	400,000 pcs	438×438×220	

单击下面可查看定价，库存，交付和生命周期等信息

[>>GP\(格瑞宝\)](#)