



Product Summary

$V_{(BR)DSS}$	$R_{DS(on)TYP}$	I_D
40V	17mΩ@10V	8A
	22mΩ@4.5V	

Feature

- High Cell Density Trenched N-ch MOSFETs
- Excellent $R_{DS(on)}$
- Low Gate Charge

Application

- Power Switching Application
- Hard Switched and High Frequency Circuits
- DC-DC Converter

MARKING:

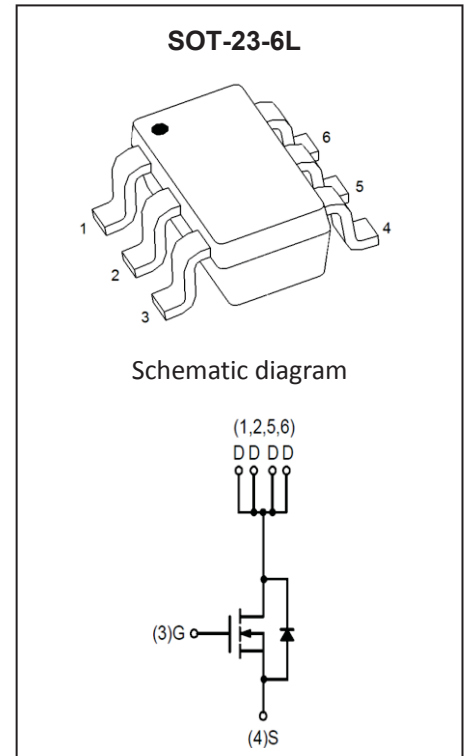
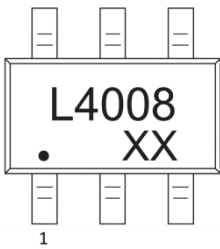

ABSOLUTE MAXIMUM RATINGS ($T_C=25^\circ\text{C}$ unless otherwise noted)

Parameter	Symbol	Value	Unit
Drain-Source Voltage	V_{DS}	40	V
Gate-Source Voltage	V_{GS}	± 20	V
Continuous Drain Current ¹	I_D	8	A
Pulsed Drain Current ²	I_{DM}	32	A
Single Pulse Avalanche Energy ³	E_{AS}	31	mJ
Avalanche Current	I_{AS}	25	A
Power Dissipation ⁴	P_D	0.45	W
Thermal Resistance from Junction to Ambient ¹	$R_{\theta JA}$	277	$^\circ\text{C/W}$
Junction Temperature	T_J	150	$^\circ\text{C}$
Storage Temperature	T_{STG}	-55~ +150	$^\circ\text{C}$

MOSFET ELECTRICAL CHARACTERISTICS (T_J=25°C unless otherwise noted)

Parameter	Symbol	Test Condition	Min	Type	Max	Unit
Static Characteristics						
Drain-source breakdown voltage	V _{(BR)DSS}	V _{GS} = 0V, I _D =250μA	40			V
Zero gate voltage drain current	I _{DSS}	V _{DS} =32V, V _{GS} = 0V			1	μA
Gate-body leakage current	I _{GSS}	V _{GS} =±20V, V _{DS} = 0V			±100	nA
Gate threshold voltage	V _{GS(th)}	V _{DS} =V _{GS} , I _D =250μA	1.0	1.6	2.5	V
Drain-source on-resistance ²	R _{DS(on)}	V _{GS} =10V, I _D =7A		17	22	mΩ
		V _{GS} =4.5V, I _D =6A		22	28	
Forward tranconductance	g _{FS}	V _{DS} =5V, I _D =7A		10		S
Dynamic characteristics						
Input capacitance	C _{iss}	V _{DS} =15V, V _{GS} =0V, f =1MHz		1013		pF
Output capacitance	C _{oss}			107		
Reverse transfer capacitance	C _{rss}			76		
Switching Characteristics						
Total gate charge@4.5V	Q _g	V _{DS} =32V, V _{GS} =4.5V, I _D =7A		9.8		nC
Gate-source charge	Q _{gs}			2.8		
Gate-drain charge	Q _{gd}			3.9		
Turn-on delay time	t _{d(on)}	V _{DD} =20V , V _{GS} =10V , R _G =3.3 Ω, I _D =7A		2.8		ns
Turn-on rise time	t _r			40.4		
Turn-off delay time	t _{d(off)}			22.8		
Turn-off fall time	t _f			6.4		
Diode Characteristics						
Continuous Source Current ^{1,5}	I _S	V _G =V _D =0V , Force Current			8	A
Diode Forward Voltage ²	V _{SD}	V _{GS} =0V , I _S =1A , T _J =25°C			1	V

Notes:

- 1.The data tested by surface mounted on a 1 inch² FR-4 board with 2OZ copper.
- 2.The data tested by pulsed , pulse width ≤ 300us , duty cycle ≤ 2%
- 3.The E_{AS} data shows Max. rating . The test condition is V_{DD} =25V, V_{GS} =10V, L=0.1mH, I_{AS} =25A
- 4.The power dissipation is limited by 150°C junction temperature
- 5.The data is theoretically the same as I_D and I_{DM} , in real applications , should be limited by total power dissipation.

Typical Electrical and Thermal Characteristics

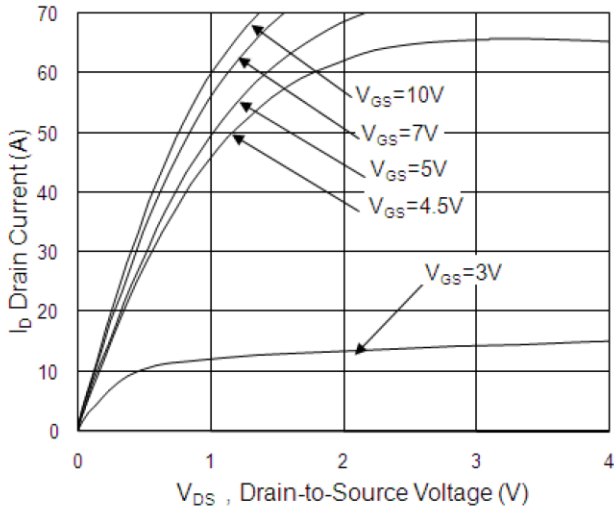

Fig.1 Typical Output Characteristics

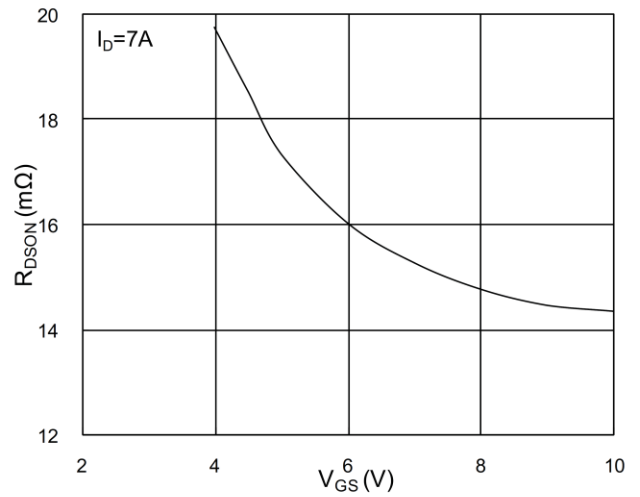

Fig.2 On-Resistance vs. G-S Voltage

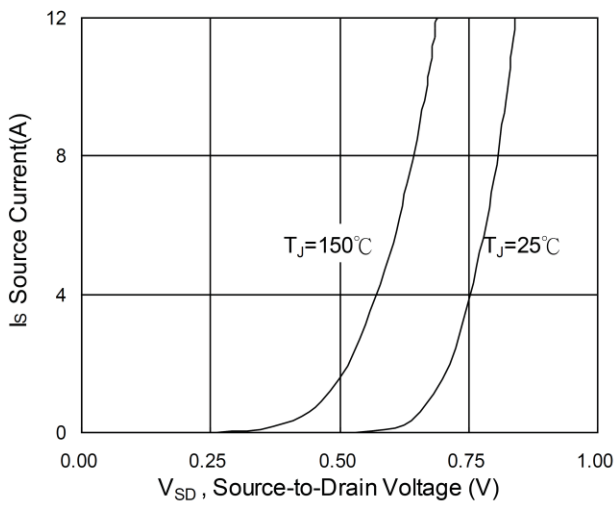

Fig.3 Forward Characteristics of Reverse

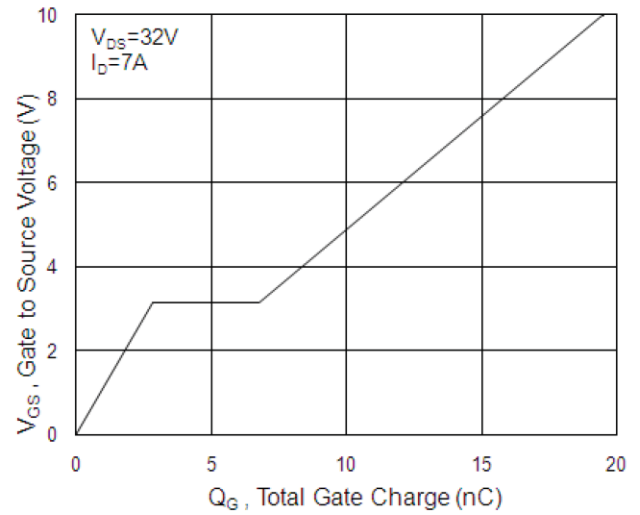

Fig.4 Gate-Charge Characteristics

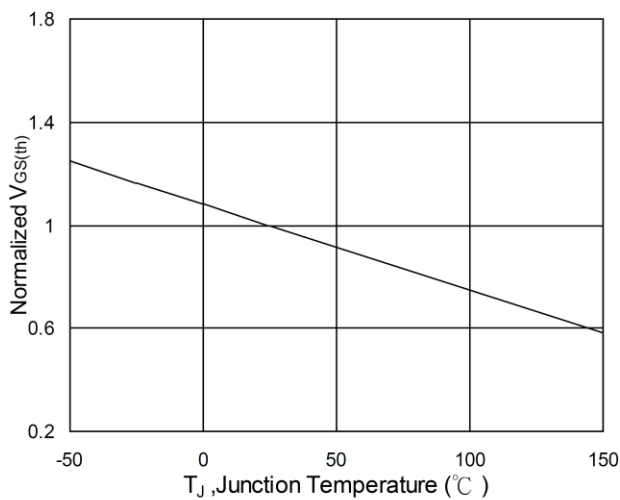

Fig.5 Normalized $V_{GS(th)}$ vs. T_J

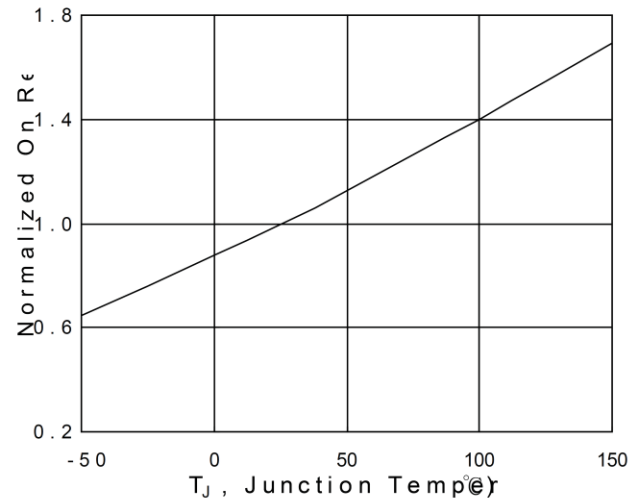

Fig.6 Normalized $R_{DS(on)}$ vs. T_J

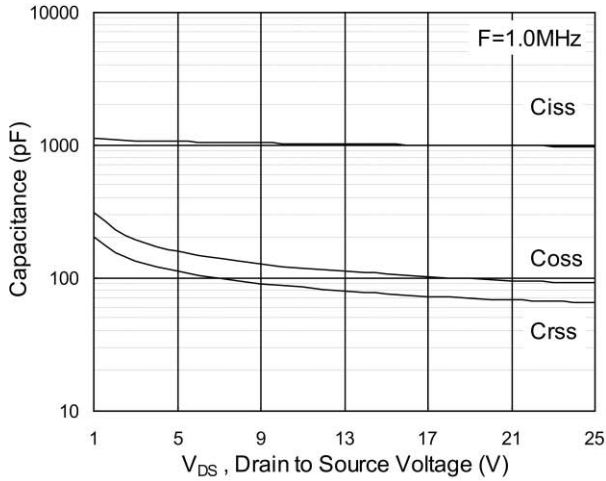

Fig.7 Capacitance

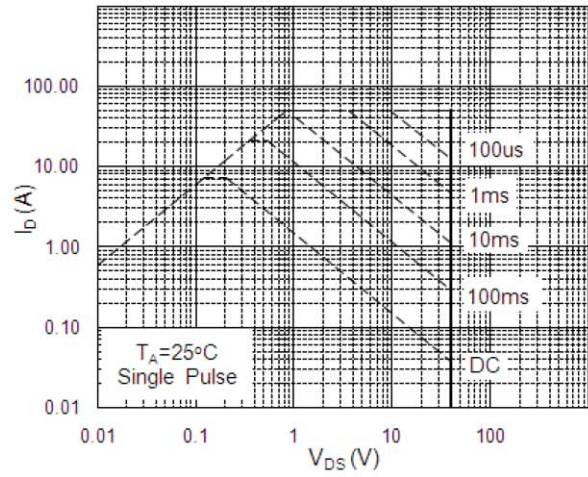

Fig.8 Safe Operating Area

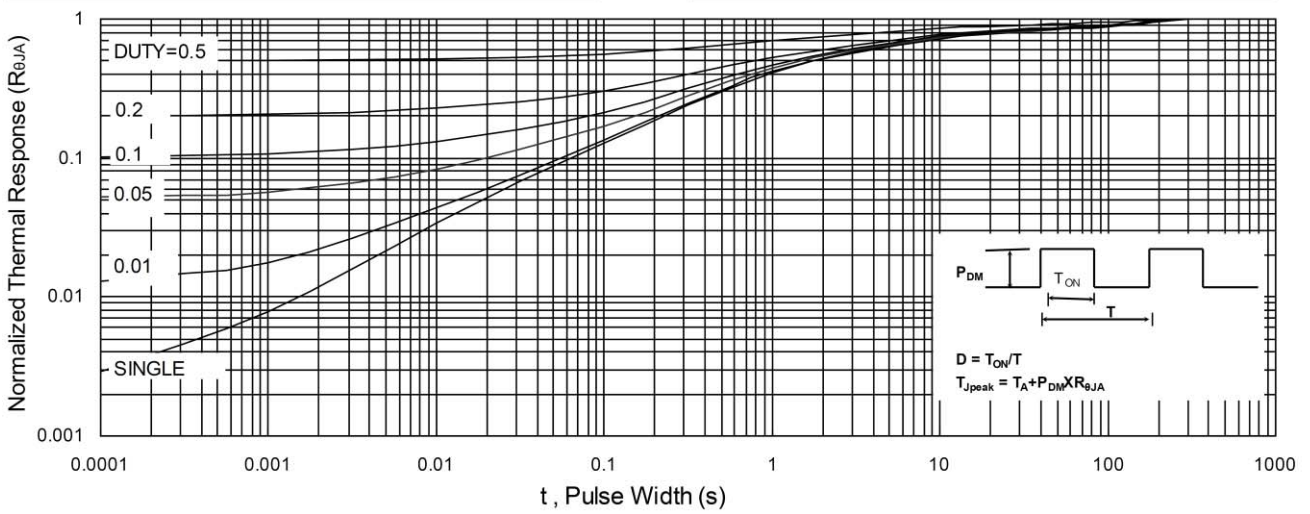
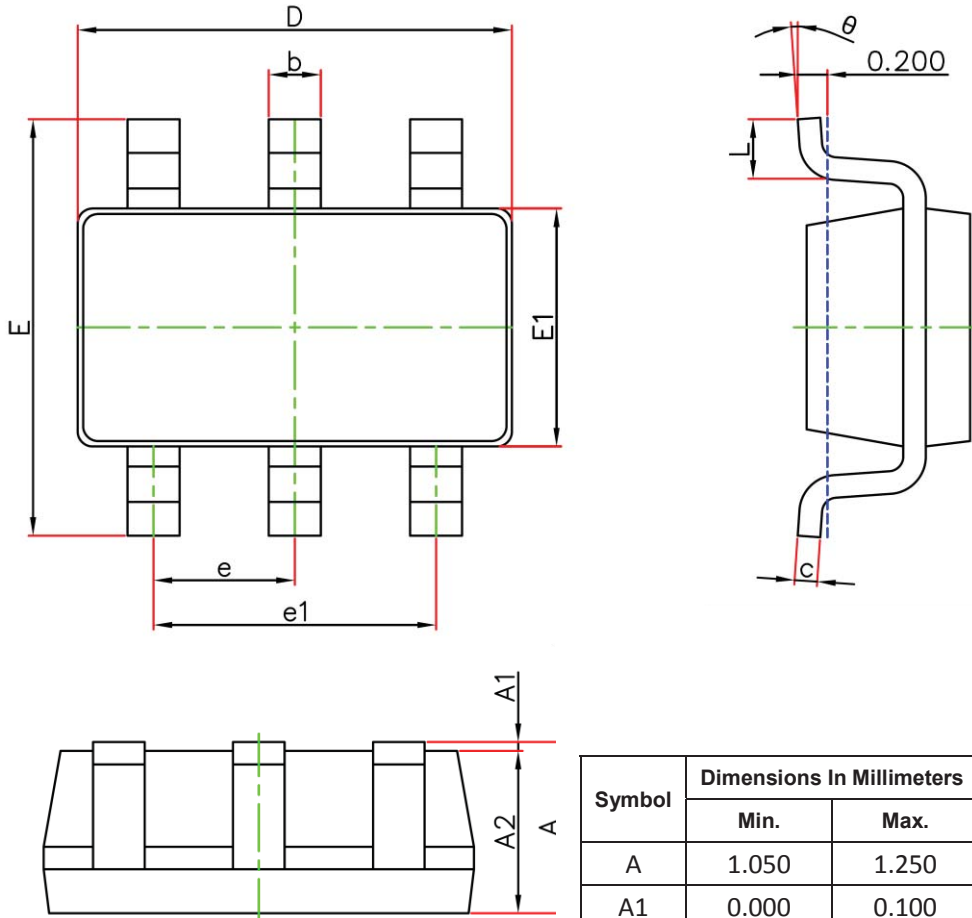

Fig.9 Normalized Maximum Transient Thermal Impedance

SOT-23-6L Package Information



Symbol	Dimensions In Millimeters		Dimensions In Inches	
	Min.	Max.	Min.	Max.
A	1.050	1.250	0.041	0.049
A1	0.000	0.100	0.000	0.004
A2	1.050	1.150	0.041	0.045
b	0.300	0.500	0.012	0.020
c	0.100	0.200	0.004	0.008
D	2.820	3.020	0.111	0.119
E1	1.500	1.700	0.059	0.067
E	2.650	2.950	0.104	0.116
e	0.950(BSC)		0.037(BSC)	
e1	1.800	2.000	0.071	0.079
L	0.300	0.600	0.012	0.024
θ	0°	8°	0°	8°

SOT-23-6L Tape and Reel

SOT-23-6L Embossed Carrier Tape

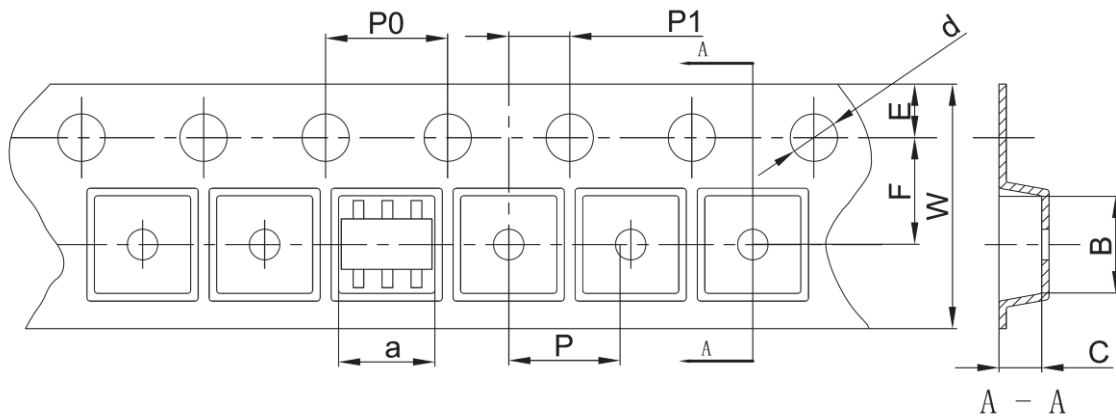

Dimensions are in millimeter										
Pkg type	a	B	C	d	E	F	P0	P	P1	W
SOT-23-6L	3.17	3.23	1.37	Φ1.55	1.75	3.50	4.00	4.00	2.00	8.00

SOT-23-6L Tape Leader and Trailer

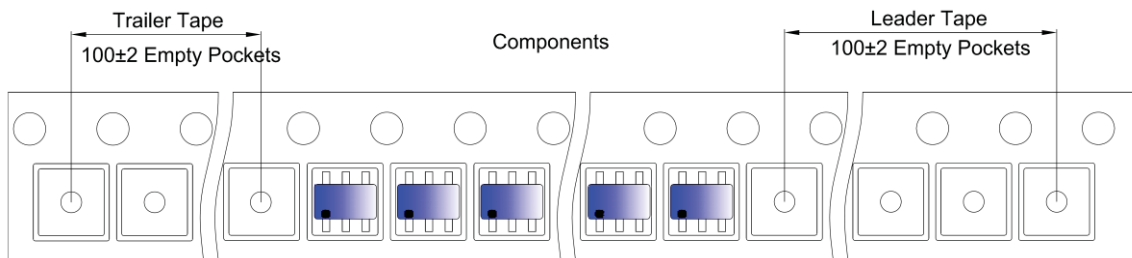

SOT-23-6L Reel

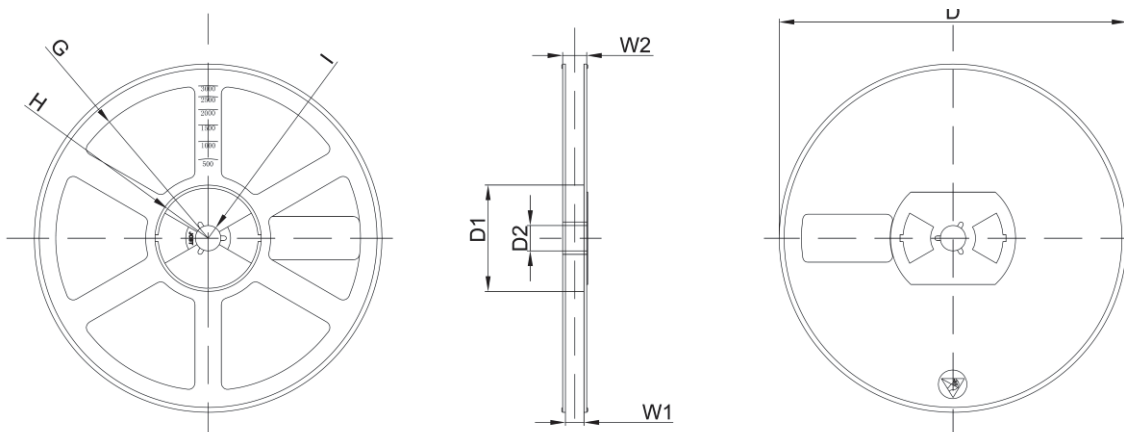

Dimensions are in millimeter								
Reel Option	D	D1	D2	G	H	I	W1	W2
7`Dia	Φ180.00	60.00	13.00	R78.00	R25.60	R6.50	9.50	12.30

Reel	Reel Size	Box	Box Size(mm)	Carton	Carton Size(mm)	G.W.(kg)
3000pcs	7 inch	30,000pcs	203×203×195	120,000pcs	438×438×220	

单击下面可查看定价，库存，交付和生命周期等信息

[>>GP\(格瑞宝\)](#)