

### Product Summary

$V_{(BR)DSS}$	$R_{DS(on)TYP}$	$I_D$
-30V	35mΩ@-10V	-5A
	55mΩ@-4.5V	

### Feature

- Trench Power MOSFET
- Excellent  $R_{DS(ON)}$

### Application

- Load Switch
- Battery Protection Applications

### MARKING:

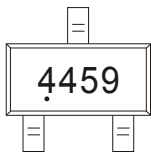

4459 = Device Cpde  
 Solid Dot = Green Molding Compound Device,  
 Otherwise Normal Device

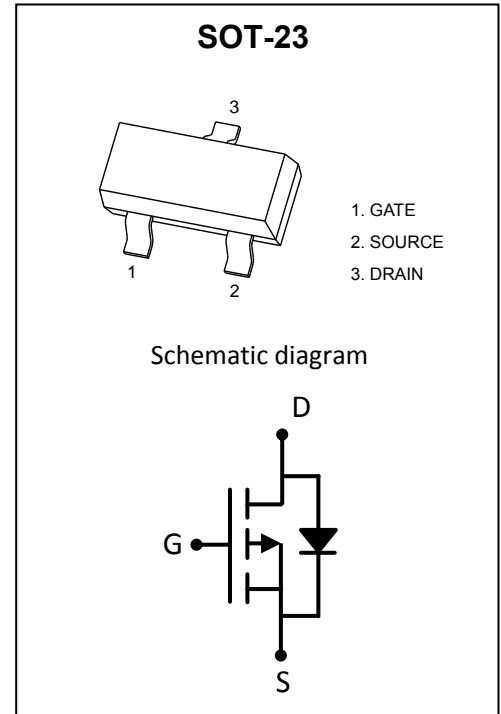

### ABSOLUTE MAXIMUM RATINGS ( $T_a=25^{\circ}C$ unless otherwise noted)

Parameter	Symbol	Value	Unit
Drain-Source Voltage	$V_{DS}$	-30	V
Gate-Source Voltage	$V_{GS}$	$\pm 20$	V
Continuous Drain Current	$I_D$	-5.0	A
Plused Drain Current	$I_{DM}$	-20	A
Maximum Power Dissipation	$P_D$	0.35	W
Thermal Resistance from Junction to Ambient	$R_{\theta JA}$	357	$^{\circ}C/W$
Junction Temperature	$T_J$	150	$^{\circ}C$
Storage Temperature	$T_{STG}$	-55~ +150	$^{\circ}C$

**MOSFET ELECTRICAL CHARACTERISTICS(T<sub>a</sub>=25°C unless otherwise noted)**

Parameter	Symbol	Test Condition	Min	Type	Max	Unit
<b>Static Characteristics</b>						
Drain-source breakdown voltage	V <sub>(BR)DSS</sub>	V <sub>GS</sub> = 0V, I <sub>D</sub> = -250μA	-30			V
Zero gate voltage drain current	I <sub>DSS</sub>	V <sub>DS</sub> = -30V, V <sub>GS</sub> = 0V			-1	μA
Gate-body leakage current	I <sub>GSS</sub>	V <sub>GS</sub> = ±20V, V <sub>DS</sub> = 0V			±100	nA
Gate threshold voltage <sup>1</sup>	V <sub>GS(th)</sub>	V <sub>DS</sub> = V <sub>GS</sub> , I <sub>D</sub> = -250μA	-1.0	-1.5	-2.5	V
Drain-source on-resistance <sup>1</sup>	R <sub>DS(on)</sub>	V <sub>GS</sub> = -10V, I <sub>D</sub> = -5A		35	46	mΩ
		V <sub>GS</sub> = -4.5V, I <sub>D</sub> = -5A		55	72	
Forward tranconductance <sup>1</sup>	g <sub>FS</sub>	V <sub>DS</sub> = -5V, I <sub>D</sub> = -5A	10			S
<b>Dynamic characteristics</b>						
Input Capacitance	C <sub>iss</sub>	V <sub>DS</sub> = -15V, V <sub>GS</sub> = 0V, f = 1MHz		850		pF
Output Capacitance	C <sub>oss</sub>			100		
Reverse Transfer Capacitance	C <sub>rss</sub>			70		
<b>Switching Characteristics</b>						
Turn-on delay time	t <sub>d(on)</sub>	V <sub>GS</sub> = -10V, V <sub>DS</sub> = -15V, R <sub>L</sub> = 2.5Ω, R <sub>GEN</sub> = 3Ω		9		ns
Turn-on rise time	t <sub>r</sub>			7		
Turn-off delay time	t <sub>d(off)</sub>			25		
Turn-off fall time	t <sub>f</sub>			10		
Total gate charge	Q <sub>g</sub>	V <sub>DS</sub> = -15V, V <sub>GS</sub> = -10V, I <sub>D</sub> = -5A		12		nC
Gate-source charge	Q <sub>gs</sub>			2.5		
Gate-drain charge	Q <sub>gd</sub>			4		
<b>Source-Drain Diode characteristics</b>						
Diode Forward voltage <sup>1</sup>	V <sub>DS</sub>	V <sub>GS</sub> = 0V, I <sub>S</sub> = -1A			-1.2	V

**Notes:**

1 Pulse Test : Pulse width ≤ 300μs, duty cycle ≤ 2%.

**Typical Electrical and Thermal Characteristics**

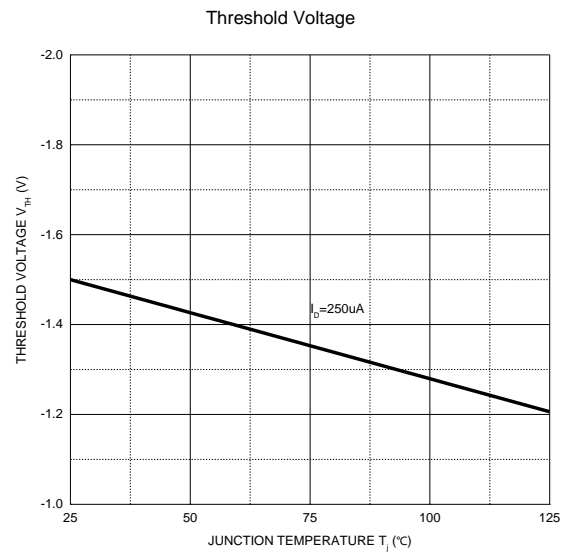
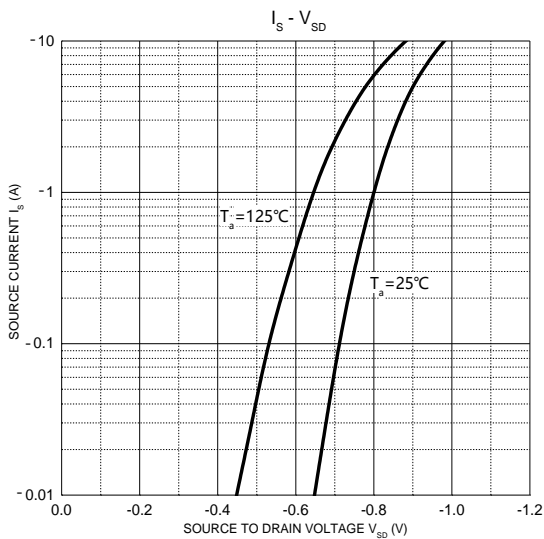
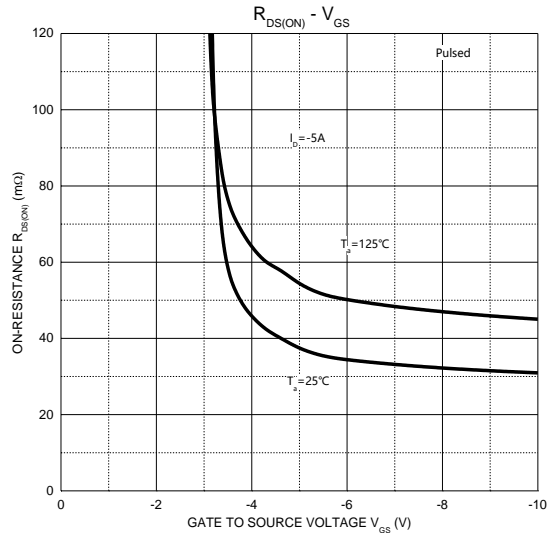
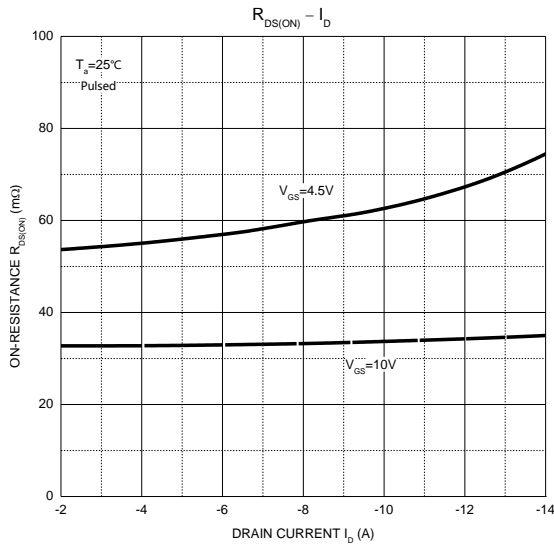
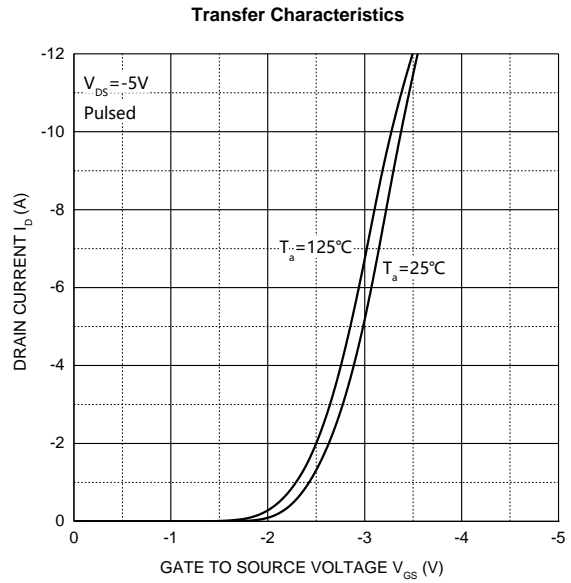
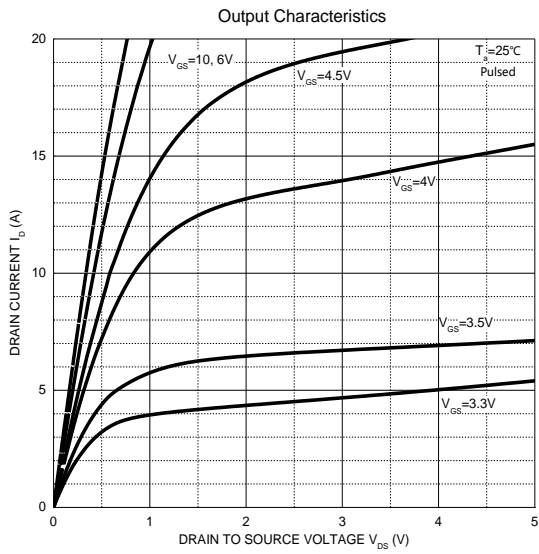

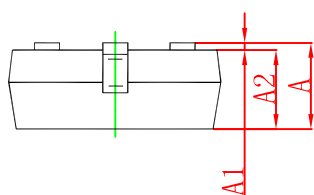
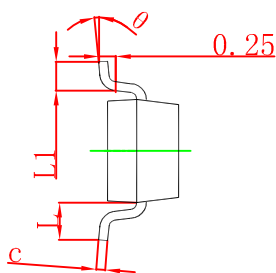
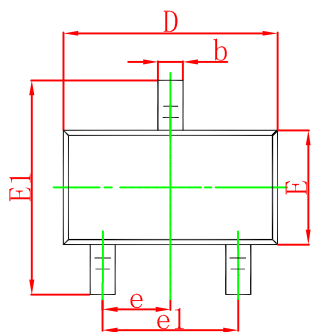
**SOT-23 Package Information**

Symbol	Dimensions In Millimeters		Dimensions In Inches	
	Min	Max	Min	Max
A	0.900	1.150	0.035	0.045
A1	0.000	0.100	0.000	0.004
A2	0.900	1.050	0.035	0.041
b	0.300	0.500	0.012	0.020
c	0.080	0.150	0.003	0.006
D	2.800	3.000	0.110	0.118
E	1.200	1.400	0.047	0.055
E1	2.250	2.550	0.089	0.100
e	0.950 TYP		0.037 TYP	
e1	1.800	2.000	0.071	0.079
L	0.550 REF		0.022 REF	
L1	0.300	0.500	0.012	0.020
θ	0°	8°	0°	8°

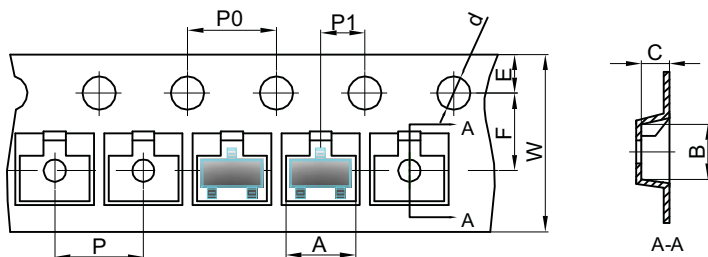
**SOT-23 Tape and Reel**
**SOT-23 Embossed Carrier Tape**

Dimensions are in millimeter										
Pkg type	A	B		d	E	F	P0	P	P1	W
SOT-23	3.15	2.77	1.22	Ø1.50	1.75	3.50	4.00	4.00	2.00	8.00

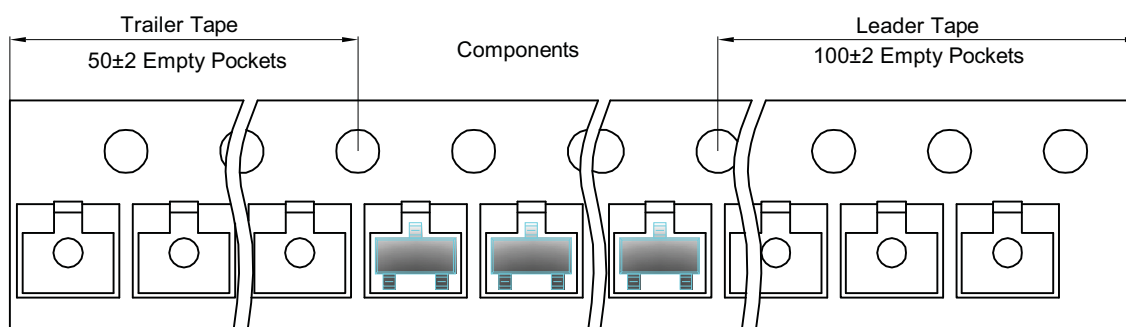
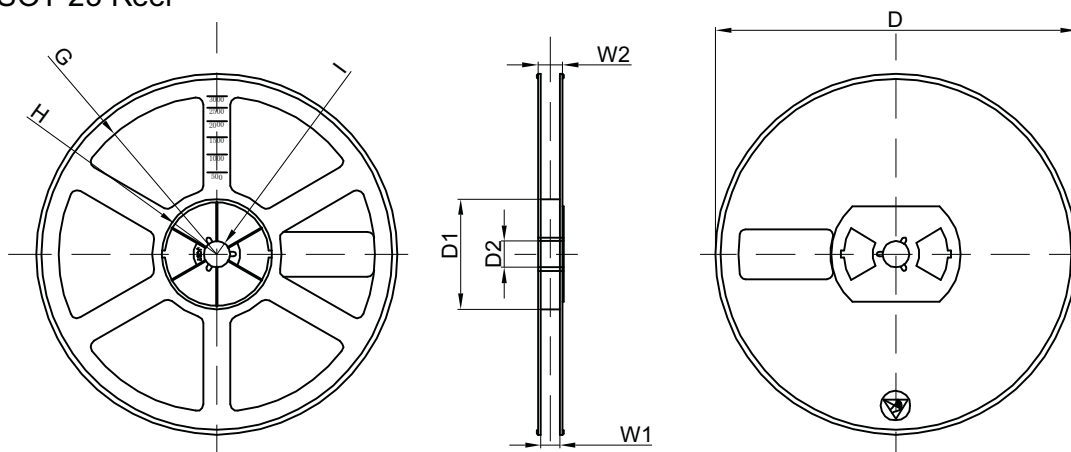
**SOT-23 Tape Leader and Trailer**

**SOT-23 Reel**

Dimensions are in millimeter								
Reel Option	D	D1	D2	G	H	I	W1	W2
7" Dia	Ø178.00	54.40	13.00	R78.00	R25.60	R6.50	9.50	12.30

REEL	Reel Size	Box	Box Size(mm)	Carton	Carton Size(mm)	G.W.(kg)
3000 pcs	7 inch	30,000 pcs	203×203×195	120,000 pcs	438×438×220	

单击下面可查看定价，库存，交付和生命周期等信息

[>>GP\(格瑞宝\)](#)