



Product Summary

$V_{(BR)DSS}$	$R_{DS(on)TYP}$	I_D
-50V	2.3Ω@-10V	-0.18A
	2.7Ω@-5V	

Feature

- Energy Efficient
- Low Threshold Voltage
- High-speed Switching
- Miniature Surface Mount Package Saves Board Space

Application

DC-DC converters, load switching, power management in portable and battery-powered products such as computers, printers, cellular and cordless telephones

MARKING:

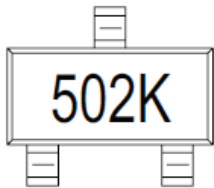

SOT-23

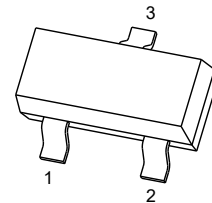

1. GATE
2. SOURCE
3. DRAIN

Schematic diagram

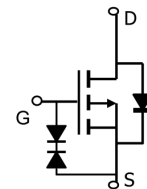

ABSOLUTE MAXIMUM RATINGS ($T_a=25^{\circ}\text{C}$ unless otherwise noted)

Parameter	Symbol	Value	Unit
Drain-Source Voltage	V_{DS}	-50	V
Gate-Source Voltage	V_{GS}	±20	V
Continuous Drain Current	I_D	-0.18	A
Plused Drain Current ⁽¹⁾ @tp<10μs	I_{DM}	-0.54	A
Power Dissipation	P_D	225	mW
Thermal Resistance from Junction to Ambient ⁽²⁾	$R_{\theta JA}$	556	$^{\circ}\text{C}/\text{W}$
Junction Temperature	T_J	150	$^{\circ}\text{C}$
Storage Temperature	T_{STG}	-55~ +150	$^{\circ}\text{C}$

MOSFET ELECTRICAL CHARACTERISTICS ($T_a=25^{\circ}\text{C}$ unless otherwise noted)

Parameter	Symbol	Test Condition	Min	Type	Max	Unit
Static Characteristics						
Drain-source breakdown voltage	$V_{(BR)DSS}$	$V_{GS} = 0V, I_D = -250\mu A$	-50			V
Zero gate voltage drain current	I_{DSS}	$V_{DS} = -50V, V_{GS} = 0V$			-1	μA
		$V_{DS} = -25V, V_{GS} = 0V$			-0.1	μA
Gate-body leakage current	I_{GSS}	$V_{GS} = \pm 20V, V_{DS} = 0V$			± 100	nA
Gate threshold voltage ⁽³⁾	$V_{GS(th)}$	$V_{DS} = V_{GS}, I_D = -250\mu A$	-0.9	-1.6	-2	V
Drain-source on-resistance ⁽³⁾	$R_{DS(on)}$	$V_{GS} = -10V, I_D = -0.1A$		2.3	6	Ω
		$V_{GS} = -5V, I_D = -0.1A$		2.7	7	
Forward transconductance ⁽¹⁾	g_{FS}	$V_{DS} = -25V, I_D = -0.1A$	50			mS
Dynamic characteristics⁽⁴⁾						
Input Capacitance	C_{iss}	$V_{DS} = -5V, V_{GS} = 0V, f = 1MHz$		22		pF
Output Capacitance	C_{oss}			7.5		
Reverse Transfer Capacitance	C_{rss}			4		
Switching characteristics⁽⁴⁾						
Turn-on delay time	$t_{d(on)}$	$V_{DD} = -15V, R_L = 50\Omega, I_D = -2.5A$		1.85		ns
Turn-on rise time	t_r			0.7		
Turn-off delay time	$t_{d(off)}$			12		
Turn-off fall time	t_f			6		
Source-Drain Diode characteristics						
Diode forward current	I_S				-0.13	A
Diode pulsed forward current	I_{SM}				-0.52	
Diode Forward voltage	V_{DS}	$V_{GS} = 0V, I_S = -0.13A$			-1.2	V

Notes :

1. Repetitive rating : Pulse width limited by junction temperature.
2. Surface mounted on FR4 board , $t \leq 10s$.
3. Pulse Test : Pulse Width $\leq 300\mu s$, Duty Cycle $\leq 2\%$.
4. Guaranteed by design, not subject to producing.

Typical Electrical and Thermal Characteristics

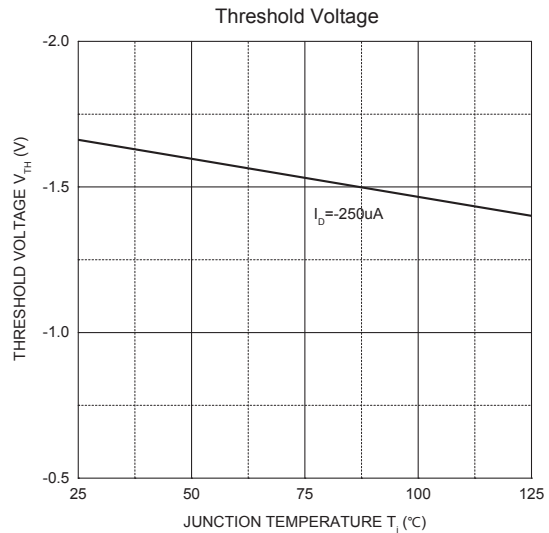
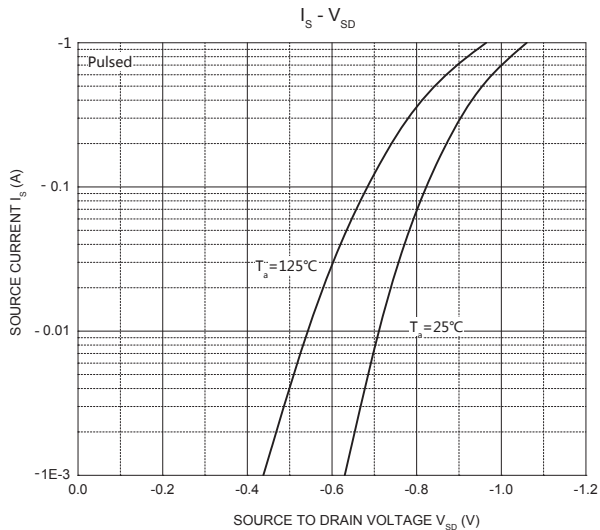
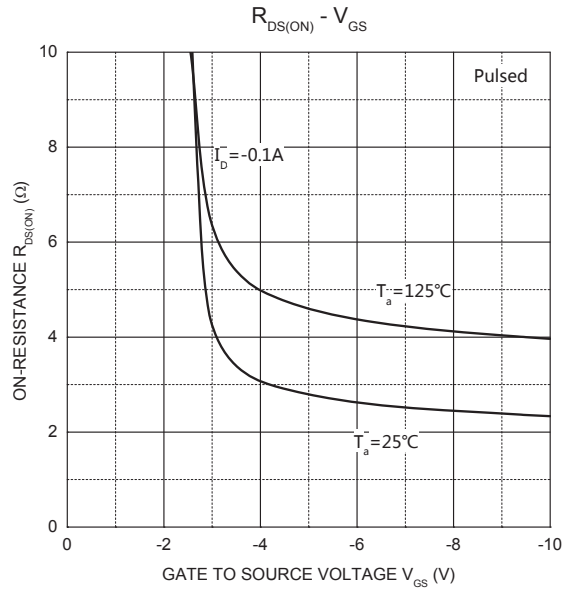
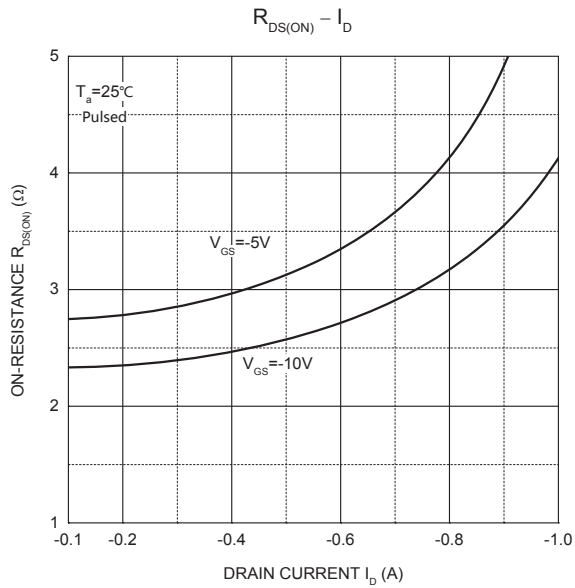
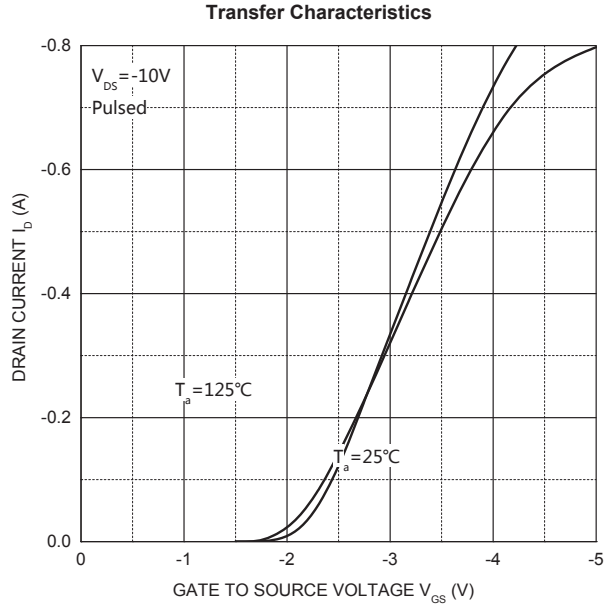
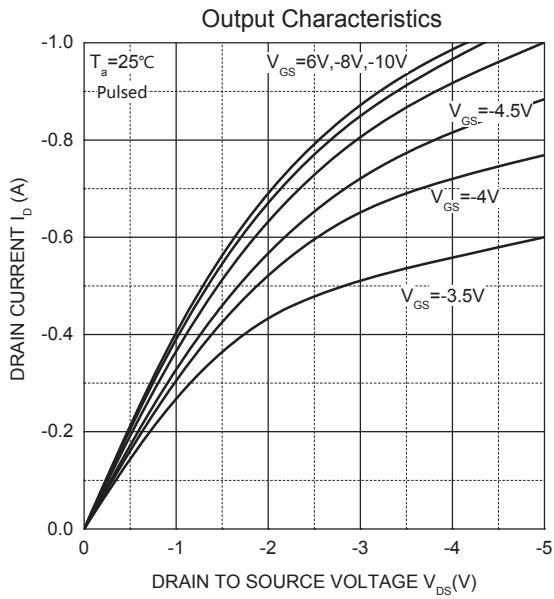

SOT-23 Package Information

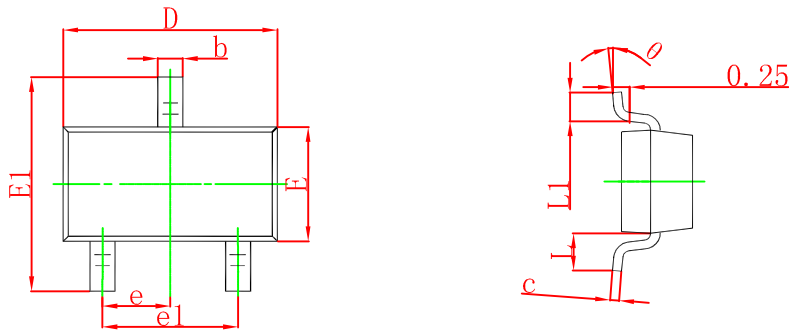

Symbol	Dimensions In Millimeters		Dimensions In Inches	
	Min	Max	Min	Max
A	0.900	1.150	0.035	0.045
A1	0.000	0.100	0.000	0.004
A2	0.900	1.050	0.035	0.041
b	0.300	0.500	0.012	0.020
c	0.080	0.150	0.003	0.006
D	2.800	3.000	0.110	0.118
E	1.200	1.400	0.047	0.055
E1	2.250	2.550	0.089	0.100
e	0.950 TYP		0.037 TYP	
e1	1.800	2.000	0.071	0.079
L	0.550 REF		0.022 REF	
L1	0.300	0.500	0.012	0.020
θ	0°	8°	0°	8°

SOT-23 Tape and reel

SOT-23 Embossed Carrier Tape

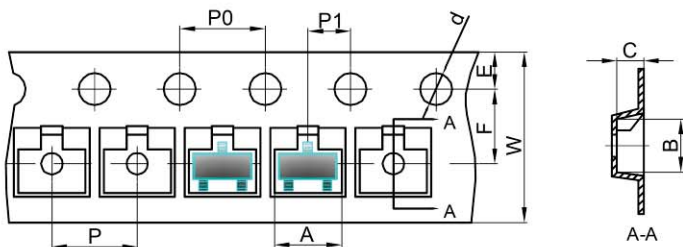

Dimensions are in millimeter										
Pkg type	A	B	C	d	E	F	P0	P	P1	W
SOT-23	3.15	2.77	1.22	Ø1.50	1.75	3.50	4.00	4.00	2.00	8.00

SOT-23 Tape Leader and Trailer

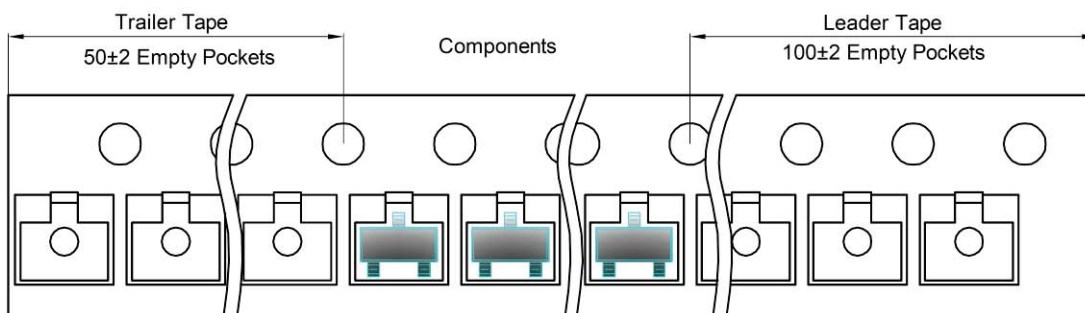

SOT-23 Reel

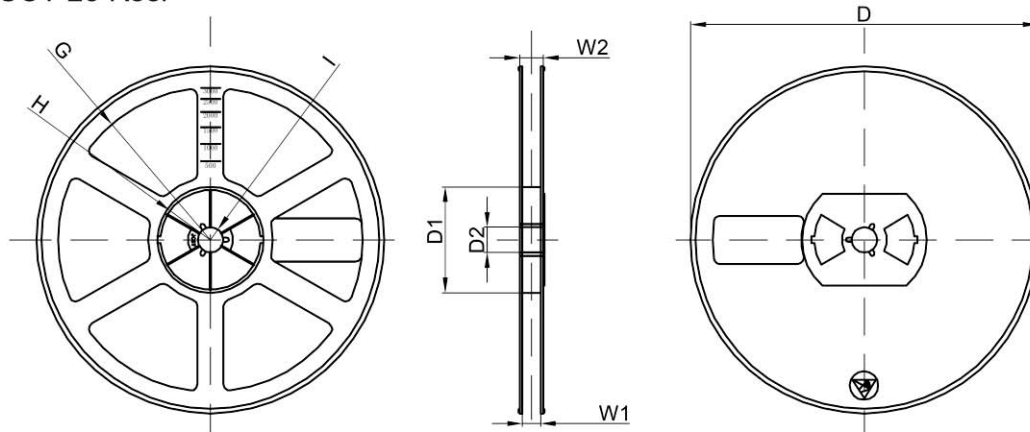

Dimensions are in millimeter								
Reel Option	D	D1	D2	G	H	I	W1	W2
7" Dia	Ø178.00	54.40	13.00	R78.00	R25.60	R6.50	9.50	12.30

REEL	Reel Size	Box	Box Size(mm)	Carton	Carton Size(mm)	G.W.(kg)
3000 pcs	7 inch	30,000 pcs	203×203×195	120,000 pcs	438×438×220	

单击下面可查看定价，库存，交付和生命周期等信息

[>>GP\(格瑞宝\)](#)