

# SPECIFICATIONS FOR APPROVAL



Customer Part No.: \_\_\_\_\_ HELE. Part No: **S2H008000I3CHE-T**

Application For: \_\_\_\_\_ Products: **OSCILLATOR**

Accepted Model: \_\_\_\_\_ Type & Freq.: **HSO221S / 8.0000MHZ**

Sample Order No: **EOS-F70285-1** Date: **2015/12/22**

Approved By :

加高電子股份有限公司  
加高電子股份有限公司

**HARMONY ELECTRONICS CORP.**

**HARMONY ELECTRONICS (THAILAND) CO., LTD.**

**HARMONY ELECTRONICS (SHENZHEN) CORP., LTD.**

**TAIPEI OFFICE:**

公司:(114)  
台北市內湖區堤頂大道 2 段 409 號 2 樓  
2F., NO.409, SEC.2, TIDING BLVD.,  
NEIHU DISTRICT, TAIPEI CITY 114,  
TAIWAN  
TEL:886-2-26588883  
FAX:886-2-26588683

**TAIWAN FACTORY:**

工廠:(831)  
高雄市大寮區大發工業區華東路 39 號  
No.39, HWA DONG RD., DALLIAO  
DIST.,DAFA INDUSTRIAL PARK.,  
KAOHSIUNG CITY 831, TAIWAN  
TEL: (07)787-1555-6  
FAX: (07)787-1557

**THAILAND FACTORY:**

66MOO 5, KAONGU-BEOKPRAI RD.,  
T.BEOKPRAI, A. BANPONG,  
RAJCHABUREE PROVINCE 70110,  
THAILAND  
TEL: (032)221994-6,  
200740-1  
FAX: (032)200742

**SHENZHEN FACTORY:**

深圳市福永鎮塘尾村橋塘路聚源工業區  
QIAO TANG RD., TANGWEI VILLAGE  
FU YONG TOWN SHENZHEN CITY  
CHINA  
TEL: 0755-27309272 /  
27309262  
FAX: 0755-27309755

Title				Country of origin		
<b>HSO221S SPECIFICATION</b>				<b>TAIWAN FACTORY</b>		
Date	Confirm	Check	Prepare	Spec. No.	Rev.	Page
<b>2015/12/22</b>	F. S. TSAI	C. H. WENG	U. F. CHEN	<b>S2H008000I3CHE-T</b>	0	1

**HARMONY ELECTRONICS CORP.**

# HSO221S SPECIFICATION

## INDEX

ITEM	PAGE
1. Type . . . . .	3
2. Output Frequency . . . . .	3
3. Absolute Maximum Ratings . . . . .	3
4. Electric Specifications . . . . .	3-4
5. Dimensions . . . . .	5
6. Inside Structure . . . . .	6
7. Mechanical Performance . . . . .	6
8. Environment Performance . . . . .	7
9. Supplement . . . . .	8-9
10. Taping and Packing . . . . .	9-12
11. Flow Chart . . . . .	13

Title				Country of origin		
<b>HSO221S SPECIFICATION</b>				<b>TAIWAN FACTORY</b>		
Date	Confirm	Check	Prepare	Spec. No.	Rev.	Page
2015/12/22	F. S. TSAI	C. H. WENG	U. F. CHEN	<b>S2H008000I3CHE-T</b>	0	2

HARMONY ELECTRONICS CORP.

1. Type Name :  
HSO221S

2. Output Frequency :  
8.000000MHz

3. Absolute Maximum Ratings :

Item	Symbol	Value	Unit
Vdd terminal voltage	Vdd	-0.5 ~ 4.0	V
Input terminal voltage	Vcont	-0.5 ~ Vdd+0.5	V
Output terminal voltage	Vout	-0.5 ~ Vdd+0.5	V
Output terminal current	Iout	15	mA
Storage temp. range	Tstr	-55~125	deg.C

4. Electric Specifications :

Item	Symbol	Value			Unit	Condition		
		Min	Typ	Max		Etc	Vdd	Temp
Frequency Stability	$\Delta f/F$	-50	-	+50	ppm		3.3+/- 0.3V	-40~85 °C
Operating temp. range	Topr	-40	25	+85	°C			
Supply voltage	Vdd	3.0	3.3	3.6	V			
Current consumption 1 (#1 pin: open or "H")	Idd1	-	-	7	mA	Fig1,2	3.3V	25+/-3 °C
Current consumption 2 (#1 pin: "L" level)	Idd2	-	-	0.01	mA			
Symmetry	Duty	40	50	60	%			
Low level output voltage	Vol	-	-	0.1xVdd	V			
High level output voltage	Voh	0.9xVdd	-	-	V			
Rise & Fall time	Tr & Tf	-	-	10	ns			
Pin #1 options	YES							
Output load	C-MOS CL=15 pF (Idd1, Idd2 test at No Load)							
Low level input current	Iil	-	-	10	uA	Fig3	3.3V	25+/-3 °C
High Level input current	Iih	-	-	10	uA			
Low level input voltage	Vil	-	-	Vddx0.3	V			
High level input voltage	Vih	Vddx0.7	-	-	V			
Output disable time	Tplz	-	-	150	ns			
Output enable time	Tpzl	-	-	10	ms			
Aging	-	-3	-	3	ppm/year			

F: Output Frequency

$\Delta f$  = Oscillation Frequency - F

Frequency Stability is inclusive of 25°C

Tolerance, operating temperature range, input voltage change,

Load change, first of aging, shock and vibration.

Moisture Sensitivity Level: Level 1

Title				Country of origin		
<b>HSO221S SPECIFICATION</b>				<b>TAIWAN FACTORY</b>		
Date	Confirm	Check	Prepare	Spec. No.	Rev.	Page
2015/12/22	F. S. TSAI	C. H. WENG	U. F. CHEN	<b>S2H008000I3CHE-T</b>	0	3

HARMONY ELECTRONICS CORP.

Fig. 1) Measurement Circuit :

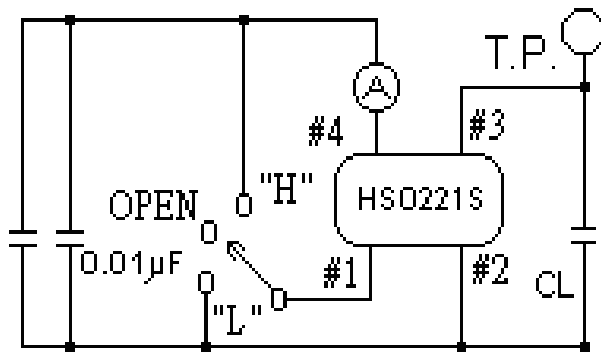

CL = Include jig & probe capacitance  
(Refer to 4)

Switch	Out term.
H	Oscillation out
Open	Oscillation out
L	High Z

Fig. 2) Output Wave Form :

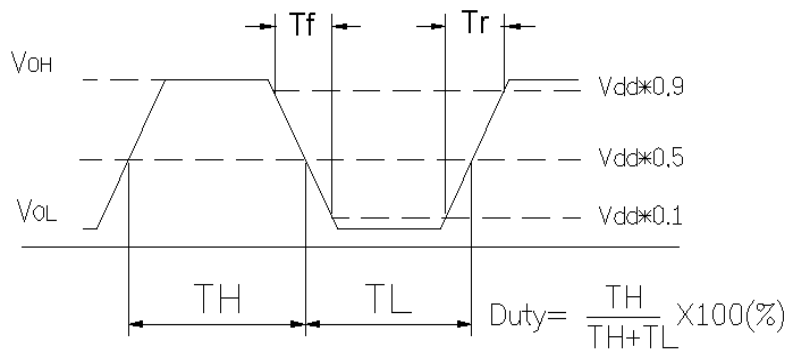
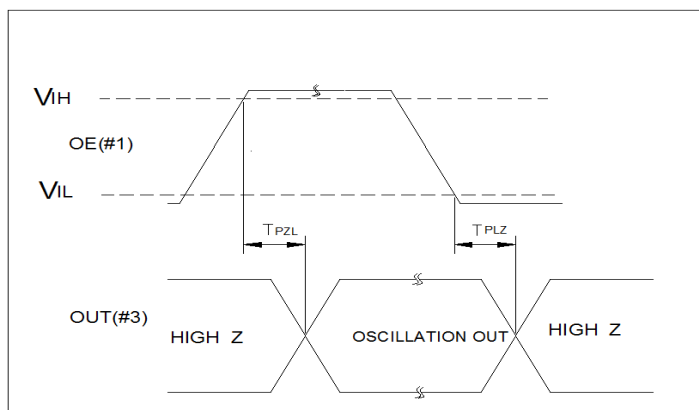

Fig. 3) Input Output Condition :



Title <b>HSO221S SPECIFICATION</b>				Country of origin <b>TAIWAN FACTORY</b>		
Date <b>2015/12/22</b>	Confirm F. S. TSAI	Check C. H. WENG	Prepare U. F. CHEN	Spec. No. <b>S2H008000I3CHE-T</b>	Rev. 0	Page 4

HARMONY ELECTRONICS CORP.

**5. Dimensions :**

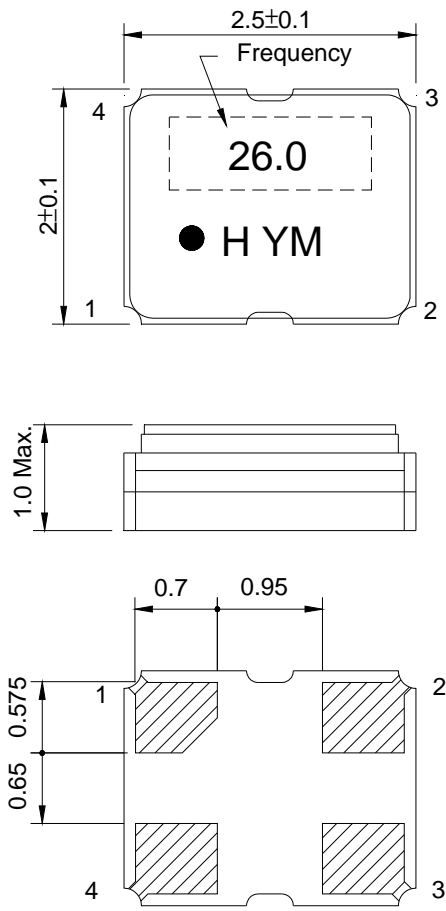

Pin Connections	
1	OE(Output Enable)
2	GND
3	Output
4	Vdd

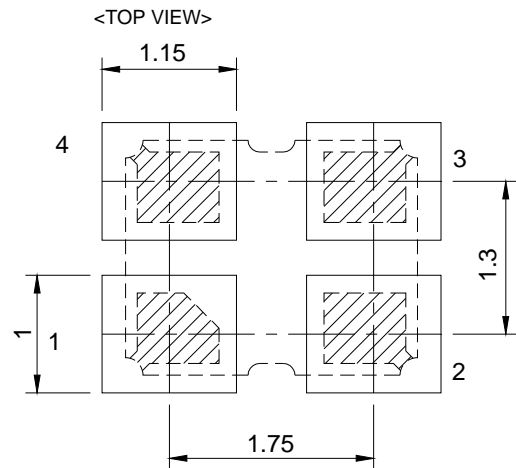

UNIT:mm  
TOLERANCE:±0.1

Lot No. :

Year : Last digit of the year

Year	2000	2001	2002	2003	2004	2005	2006	2007	2008	2009
	2010	2011	2012	2013	2014	2015	2016	2017	2018	2019
Code	0	1	2	3	4	5	6	7	8	9

Month : Alphabet assign below

Month	1	2	3	4	5	6	7	8	9	10	11	12
Code	A	B	C	D	E	F	G	H	J	K	L	M

Marking : Laser marking

Title <b>HSO221S SPECIFICATION</b>				Country of origin <b>TAIWAN FACTORY</b>			
Date <b>2015/12/22</b>	Confirm F. S. TSAI	Check C. H. WENG	Prepare U. F. CHEN	Spec. No. <b>S2H008000I3CHE-T</b>	Rev. 0	Page 5	

**HARMONY ELECTRONICS CORP.**

## 6. Inside Structure :

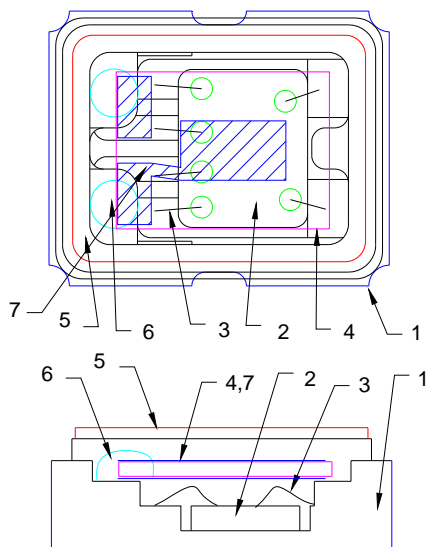

### Reference drawing

(1) Base:	Alumina Ceramic (Al <sub>2</sub> O <sub>3</sub> ) Metalized Pad: W Ni Plating Au Plating
(2) IC:	IC(Si. Al.)
(3) Au Bonding Wire:	Au
(4) Crystal Blank	Rectangular At-Cut Quartz Crystal Blank
(5) LID:	Fe+Ni+Co
(6) Adhesive	Silver Conductive Silicon Resin
(7) Electrode	

The use prohibition chemistry substance of Table 1 of DHE-0204-1 (HE-QA-24) is not included in this item.

## 7. Mechanical Performance :

Item		Test Methods	Specifications Code
1	Natural Drop	Drop 3 times from the height of 50cm onto min. 30mm thickness hard wooden board. Refer to: JIS C 60068-2-6	A
2	Vibration	Frequency 10-55Hz, Sine Wave full amplitude of 0.8mm to X, Y and Z 3 axes, Duration of 2 hours to each axis. Refer to: MIL-HDBK-781A 6.5.2/ JIS C 60068-2-6	A
3	Sealing Tightness	(1) Leak Rate 1.0x10 <sup>-8</sup> Pa·m <sup>3</sup> /sec. Max. Measured by Helium leak detector. – Fine Leakage. (2) Dipping in the FC-40 at +125 +/-5deg.C for 5 minutes, no gas bubble observed from the inside of the can.	---
4	Solder ability	After applying ROSIN Flux, dipping in solder bath at 245deg.C +/-5deg.C for 3 +/-0.5 sec. Refer to: JIS C 60068-2-20	B

Title				Country of origin		
<b>HSO221S SPECIFICATION</b>				<b>TAIWAN FACTORY</b>		
Date	Confirm	Check	Prepare	Spec. No.	Rev.	Page
2015/12/22	F. S. TSAI	C. H. WENG	U. F. CHEN	<b>S2H008000I3CHE-T</b>	0	6

HARMONY ELECTRONICS CORP.

## 8. Environment Performance :

Item		Test Methods	Specifications Code
1	Humidity	Temperature 60°C +/-2°C ,RH 90~95%, Duration of 240 hours. Back to room temperature first, then in 1~2 hours, the component shall be checked. Refer to: JIS C 60068-2-3	A
2	Storage in Low Temperature	-40deg.C +/-2deg.C, Duration of 240 hours. Back to the room temperature first, then in 1~2 hours, the component shall be checked. Refer to: JIS C 60068-2-1	A
3	Storage in High Temperature	+85deg.C +/-2deg.C, Duration of 240 hours. Back to the room temperature first, then in 1~2 hours, the component shall be checked. Refer to: JIS C 60068-2-2	A
4	Temperature cycles	-30deg.C +/-2deg.C (30min) ↔ +80deg.C +/-2deg.C (30min) 25 cycles. Temp. increasing or reducing time need to be within 3 minutes. Back to the room temperature first, then in 1~2 hours, the component shall be checked. Refer to: JIS C 0025	A
5	High Temperature Operation	+85deg.C +/-2deg.C, +3.3V Vdd Duration of 240 hours. Back to the room temperature first, then in 1~2 hours, the component shall be checked. Refer to: JIS C 60068-2-2	A

Specifications code	Specifications
A	Frequency variation shall be within +/-5ppm and equivalent resistance shall be within the specification after the test
B	More than 90% of lead shall be covered by new solder.

Title <b>HSO221S SPECIFICATION</b>				Country of origin <b>TAIWAN FACTORY</b>		
Date <b>2015/12/22</b>	Confirm F. S. TSAI	Check C. H. WENG	Prepare U. F. CHEN	Spec. No. <b>S2H008000I3CHE-T</b>	Rev. 0	Page 7

HARMONY ELECTRONICS CORP.

**9. Supplement :**

9.1. Please stay with our proposed reflow condition and do then soldering 2 times max.

*Available for Lead Free Soldering*

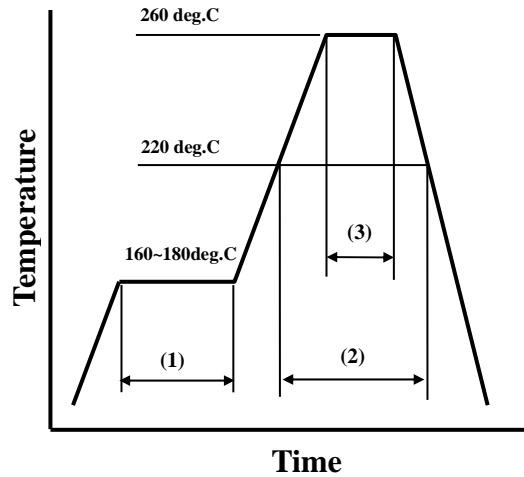

(1)	Preheat	160~180 deg.C	120sec.
(2)	Primary heat	220 deg.C	60sec.
(3)	Peak	260 deg.C	10sec. Max.

9.2. Land Pattern Layout : (Example)

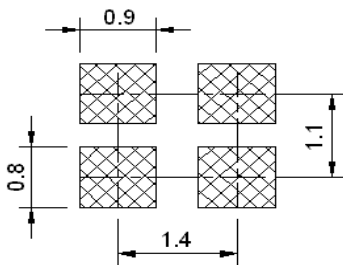

9.3. Solder Iron : (Example)

Bit temp.: 350deg.C Max. , Time: 3sec Max. , Each terminal solder a 1 time Max.

Title <b>HSO221S SPECIFICATION</b>				Country of origin <b>TAIWAN FACTORY</b>		
Date <b>2015/12/22</b>	Confirm F. S. TSAI	Check C. H. WENG	Prepare U. F. CHEN	Spec. No. <b>S2H008000I3CHE-T</b>	Rev. 0	Page 8

**HARMONY ELECTRONICS CORP.**



9.4.Mounting :

This component is designed for automatic insertion.  
However, you are requested to do the trial with your insertion machine in order to be Sure of proper operation and no damage of component.  
Please pay attention to board warp which may damage the component and cause Soldering Process.  
Avoid mounting and processing by Ultrasonic welding because this method has a Possibility of an excessive vibration spreading inside the crystal products and Becoming the cause of characteristic deterioration and not oscillating.

9.5.Cleaning :

Cleaning liquid which corrodes Nickel shall not be used.  
It may cause the problem on the surface, color, marking etc.  
Ultra-sonic cleaning is possible, however, you are requested to check on your board. Because we only checked as single unit.

9.6.Handling :

HSO211S series is designed to withstand Drop and Vibration, however, the crystal blank might be broken. So, if excess force is given, please check the characteristics before use.  
HSO221S series has C-MOS circuit inside. Please pay attention to static-electricity as same handling as other C-MOS. devices.

9.7.By-pass Capacitor :

It has no by-pass capacitor integrated. We recommend you to use capacitor (like ceramic chip capacitor) 0.01µF in-between Vdd and GND.

9.8.Storage :

Please keep away from high temperature and high humidity, which may cause put solderbility. No direct Sunlight, No dew as well.

Title				Country of origin		
<b>HSO221S SPECIFICATION</b>				<b>TAIWAN FACTORY</b>		
Date	Confirm	Check	Prepare	Spec. No.	Rev.	Page
<b>2015/12/22</b>	F. S. TSAI	C. H. WENG	U. F. CHEN	<b>S2H008000I3CHE-T</b>	0	9

## 10. Taping and Packing :

### 10.1. Emboss Tape Specifications :

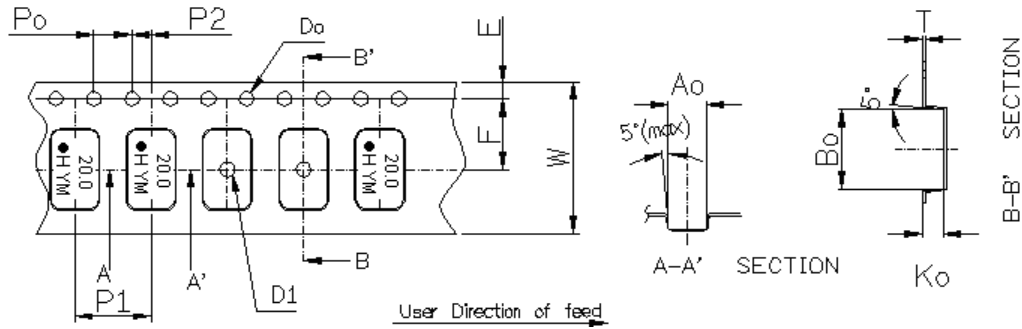

Symbol	A <sub>0</sub>	B <sub>0</sub>	K <sub>0</sub>	P <sub>0</sub>	P <sub>1</sub>	P <sub>2</sub>
Spec	2.25±0.05	2.7±0.05	1.15±0.05	4.0±0.1	4.0±0.1	2.0±0.05
Symbol	E	F	D <sub>0</sub>	D <sub>1</sub>	W	T
Spec	1.75±0.1	3.5±0.05	∅1.55±0.05	∅1.1±0.1	8.0±0.2	0.25±0.05

### 10.2. Reel Specifications :

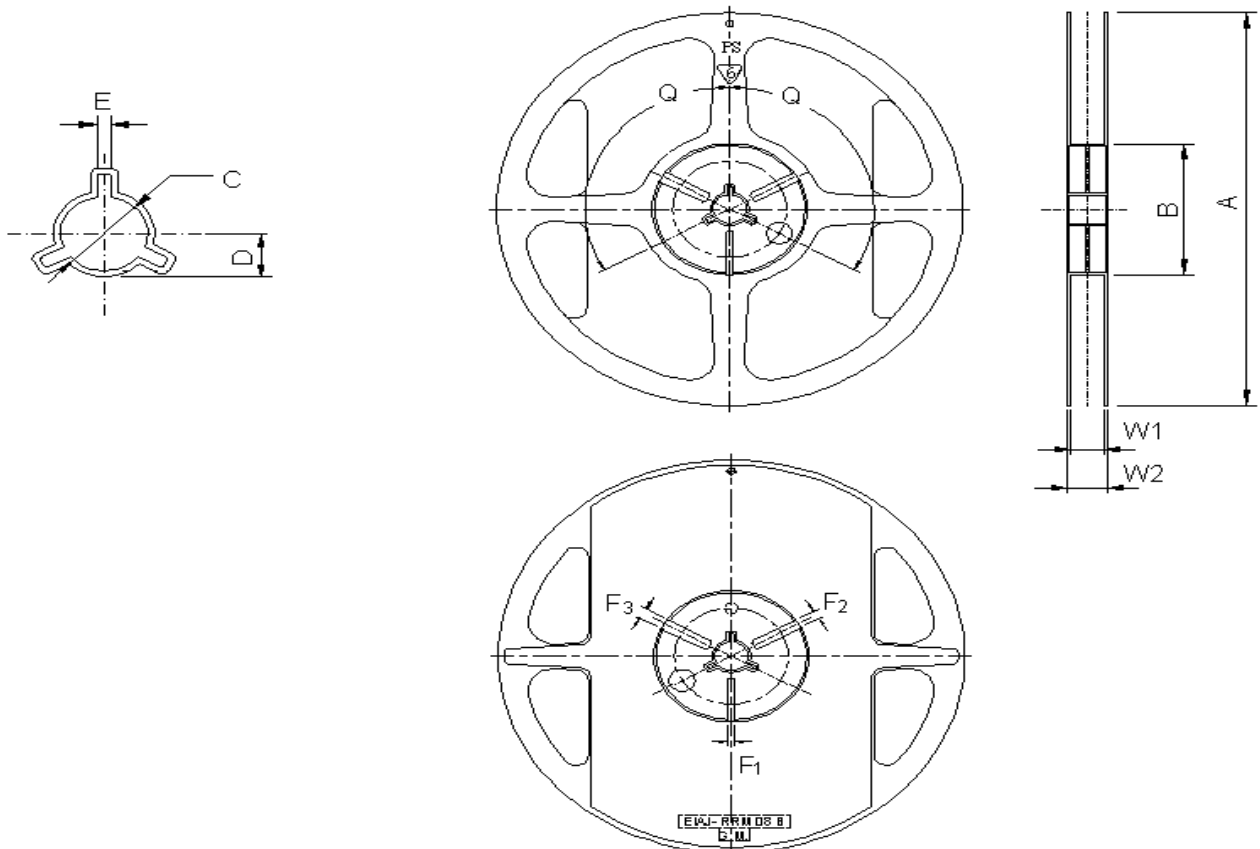

Title <b>HSO221S SPECIFICATION</b>				Country of origin <b>TAIWAN FACTORY</b>		
Date <b>2015/12/22</b>	Confirm F. S. TSAI	Check C. H. WENG	Prepare U. F. CHEN	Spec. No. <b>S2H008000I3CHE-T</b>	Rev. 0	Page 10

HARMONY ELECTRONICS CORP.

(Table-2)

(UNIT: mm)

ITEM		MARK	DIMENSIONS • ANGLE	
FLANCE	Diameter	A	$\psi 180+0/-3$	
	Inner Width	W1	$9.3+/-0.3$	
	Outer Width	W2	$11.3+/-1.0$	
HUB	Out Line diameter	B	$\psi 60.5+/-0.5$	
	Center Core slit	Width	F1	$3.0+0.5/-0$
			F2	$4.0+0.5/-0$
			F3	$5.0+0.5/-0$
		Position	Q	120deg
	Spindle diameter		C	$\psi 13.2+/-0.5$
Key Ditch	Width	E	$3.0+/-0.2$	

## 10.3.Storage :

Temperature+40deg.C Max.

Humidity 80% Max.

## 10.4.Quantity on Reel :

3,000 PCS/REEL

## 10.5.Label :

Label is following information :

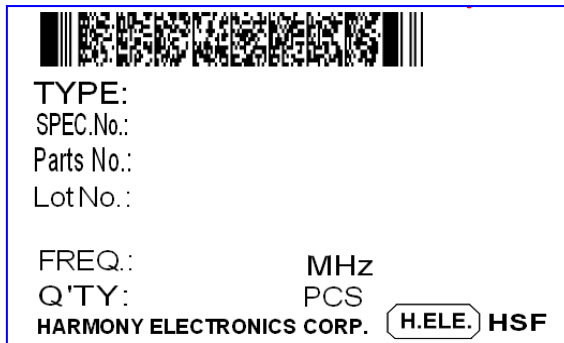

Title <b>HSO221S SPECIFICATION</b>				Country of origin <b>TAIWAN FACTORY</b>		
Date <b>2015/12/22</b>	Confirm F. S. TSAI	Check C. H. WENG	Prepare U. F. CHEN	Spec. No. <b>S2H008000I3CHE-T</b>	Rev. 0	Page 11

HARMONY ELECTRONICS CORP.

10.6. PACKAGE :

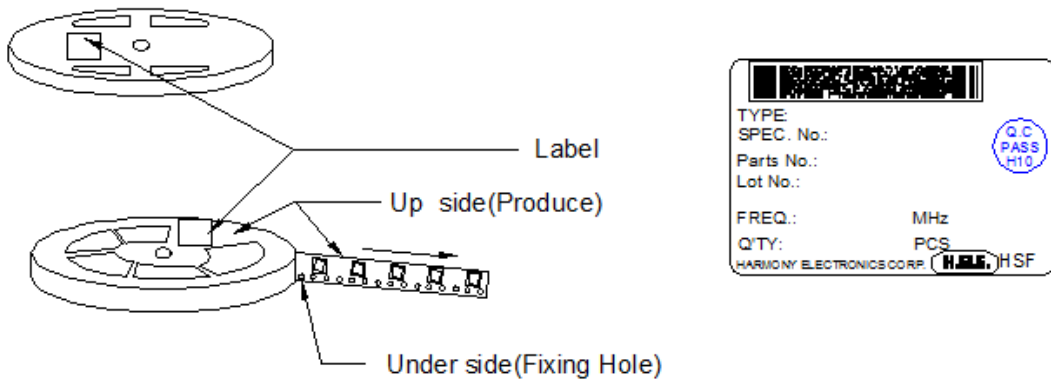

One reel quantity: [1000pcs]&[3000pcs]

- ① Top and bottom with 2.3cm thickness foam-rubber cushion for protection.
- ② Carton's QTY: 1~15 pcs.
- ③ Carton Type=A,B,C use 4 trigon pillar to fasten the Reel.
- ④ Need to add 3 pages dry agent in each outer box.

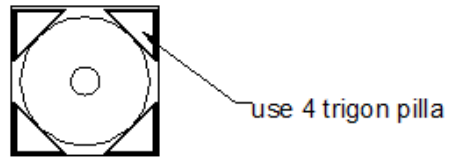

Green Product

ROHS Compliant

Carton Type	A	B	C	D
Produce Type	840/751	630/531/ 421	321/221/ 211/111	OTHER
Reel	15	15	15	1~7
L±3	200	200	200	195
W±3	200	200	200	195
H±3	230/260	230	230	150

- 1. Every Carton with 3 desiccant.
- 2. Top and bottom with 2.3cm thickness foam-rubber cushion for protection

Title <b>HSO221S SPECIFICATION</b>				Country of origin <b>TAIWAN FACTORY</b>		
Date <b>2015/12/22</b>	Confirm F. S. TSAI	Check C. H. WENG	Prepare U. F. CHEN	Spec. No. <b>S2H008000I3CHE-T</b>	Rev. 0	Page 12

**HARMONY ELECTRONICS CORP.**

11. Flow Chart :

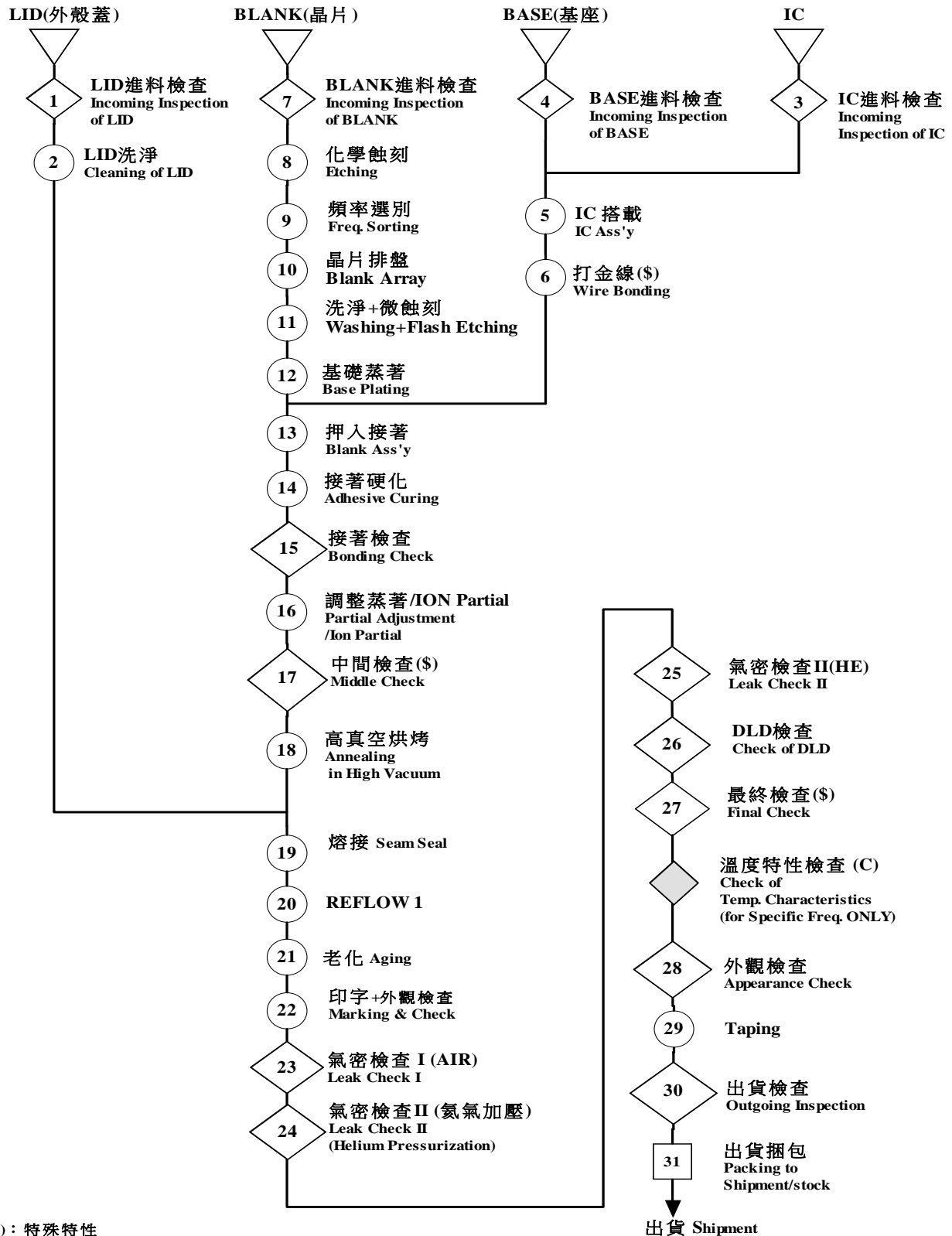

(\$): 特殊特性  
(For Special Characteristics)  
(C): 指定製程  
(Arranged for customer requirement)

Title <b>HSO221S SPECIFICATION</b>				Country of origin <b>TAIWAN FACTORY</b>		
Date <b>2015/12/22</b>	Confirm F. S. TSAI	Check C. H. WENG	Prepare U. F. CHEN	Spec. No. <b>S2H008000I3CHE-T</b>	Rev. 0	Page 13



单击下面可查看定价，库存，交付和生命周期等信息

[>>HELE\(加高\)](#)