

# H.ELE.

## Specifications for Approval



PRODUCT TYPE	Crystal Oscillator HSO321S
NOMINAL FREQUENCY	22.579200MHz
H.ELE. SAMPLE O/N	EOS-J40409-8
H.ELE. P/N	SSW022579E3CH
RELEASE DATE	2019/04/30
VERSION	00
MSL	Level 1
GREEN PRODUCT	<input checked="" type="checkbox"/> Pb free <input checked="" type="checkbox"/> RoHS Compliant <input checked="" type="checkbox"/> HF-Halogen free <input checked="" type="checkbox"/> REACH Compliant
CUSTOMER P/N	
APPLICATION & MODEL	
APPROVED BY CUSTOMER	

(DATE)

<b>Harmony Electronics Corp.</b>			
<u>F. S. TSAI</u> (APPROVE)	<u>C. H. WENG</u> (CHECK)	<u>U. F. CHEN</u> (PREPARE)	Country of Origin: Taiwan Factory Thailand Factory China Factory

### HARMONY ELECTRONICS CORPRATION

KAOHSIUNG

TAIPEI

THAILAND

SHENZHEN

DONGGUAN

TEL: 886-2-26588883

Email: [contactus@hele.com.tw](mailto:contactus@hele.com.tw)





## Contents

ITEM	PAGE
1. CRYSTAL OSCILLATOR SPECIFICATION	3-4
2. DIMENSIONS	4
3. MARKING	5
4. INSIDE STRUCTURE	5
5. HANDLING SUGGESTIONS	5-6
6. EMBOSS CARRIER TAPE&REEL	7-8
7. PACKAGE	8
8. MECHANICAL PERFORMANCE	9
9. ENVIRONMENTAL PERFORMANCE	9
10. APPENDIX	

### HARMONY ELECTRONICS CORPRATION

KAOHSIUNG

TAIPEI

THAILAND

SHENZHEN

DONGGUAN

TEL: 886-2-26588883

Email: [contactus@hele.com.tw](mailto:contactus@hele.com.tw)



## 1. CRYSTAL OSCILLATOR SPECIFICATION

### ■ Electrical Specifications

Items	Symbol	Electrical Spec.			Unit	Condition	
		Min	Type	Max			
Output Frequency	(FL)	22.579200			MHz		
Mode of Oscillation		Fundamental					
Frequency Stability	$\Delta f/F$	-25	-	+25	ppm	@3.3±0.3V/-10~70°C	
Operating temp. range	Topr	-10	25	+70	°C		
Supply voltage	Vdd	3.0	3.3	3.6	V		
Pin #1 options		YES					
Output load		C-MOS CL=15pF (Idd1, Idd2 test at No Load)					
Current consumption 1 (#1 pin: open or "H")	Idd1	-	-	10	mA	@3.3V/ 25±3°C	
Current consumption 2 (#1 pin: "L" level)	Idd2	-	-	0.01	mA		
Low level output voltage	Vol	-	-	0.1xVdd	V		
High level output voltage	Voh	0.9xVdd	-	-	V		
Symmetry	Duty	40	50	60	%		
Rise & Fall time	Tr & Tf	-	-	7	ns		
Low level input current	Iil	-	-	10	uA		
High Level input current	Iih	-	-	10	uA		
Low level input voltage	Vil	-	-	Vddx0.3	V		
High level input voltage	Vih	Vddx0.7	-	-	V		
Output disable time	Tplz	-	-	150	nsec		
Output enable time	Tpzl	-	-	10	msec		
Aging	-	-3	-	3	ppm/year		
Start-up time		-	-	10	ms		
Jitter, Phase	RMS(1-σ)	-	-	1	ps		12KHz~20MHz Frequency Band

Note: Storage Temperature is only for the product itself.

### ■ Absolute Maximum Ratings

Item	Symbol	Value	Unit
Vdd terminal voltage	Vdd	-0.5 ~ 4.0	V
Input terminal voltage	Vcont	-0.5 ~ Vdd+0.5	V
Output terminal voltage	Vout	-0.5 ~ Vdd+0.5	V
Output terminal current	Iout	15	mA
Storage temp. range	Tstr	-55 ~ 125	deg.C

## HARMONY ELECTRONICS CORPRATION

KAOHSIUNG

TAIPEI

THAILAND

SHENZHEN

DONGGUAN

TEL: 886-2-26588883

Email: contactus@hele.com.tw



### TEST Circuit

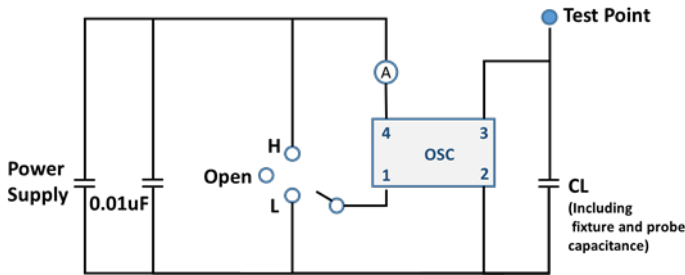

CL = Include jig & probe capacitance  
(Refer to 4)

Switch	Out term.
H	Oscillation out
Open	Oscillation out
L	High Z

### Output Wave Form

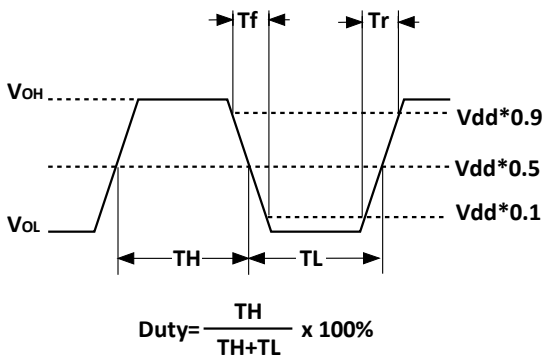

### Input and Output Condition

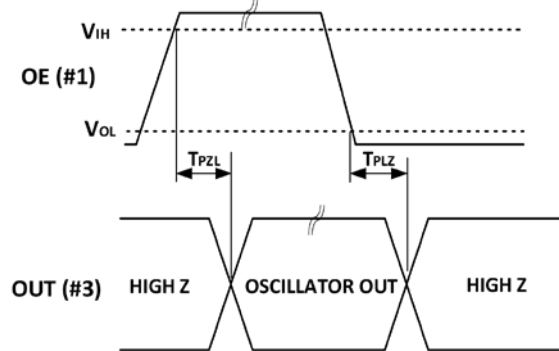

## 2. DIMENSION

TOP VIEW

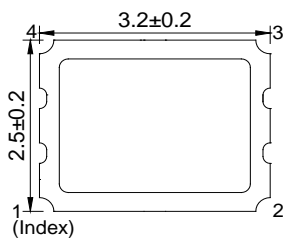

BOTTOM VIEW

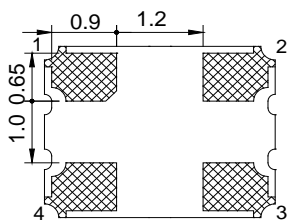

Tolerance: ±0.1  
Unit: mm

TOP VIEW  
Land Pattern Layout

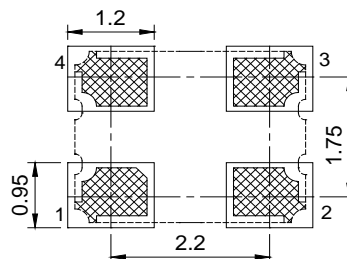

Pin Connections	
1	OE(Output Enable)
2	GND
3	Output
4	Vdd

\* Note: The Index mark was defined by the BASE suppliers.

# HARMONY ELECTRONICS CORPRATION

KAOHSIUNG

TAIPEI

THAILAND

SHENZHEN

DONGGUAN

TEL: 886-2-26588883

Email: [contactus@hele.com.tw](mailto:contactus@hele.com.tw)



### 3. MARKING

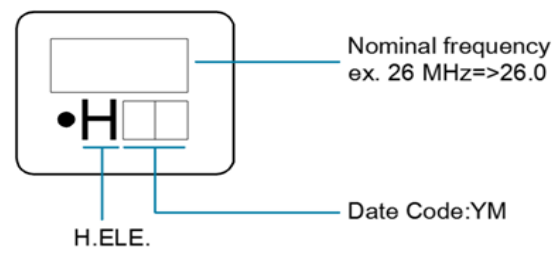

Note:

1. Laser marking.
2. Date Code:

Y= Year	2010	2011	2012	2013	2014	2015	2016	2017	2018	2019
	2020	2021	2022	2023	2024	2025	2026	2027	2028	2029
Code	0	1	2	3	4	5	6	7	8	9

M= Month	Jan.	Feb.	Mar.	Apr.	May.	Jun.	Jul.	Aug.	Sep.	Oct.	Nov.	Dec.
Code	A	B	C	D	E	F	G	H	J	K	L	M

### 4. INSIDE STRUCTURE

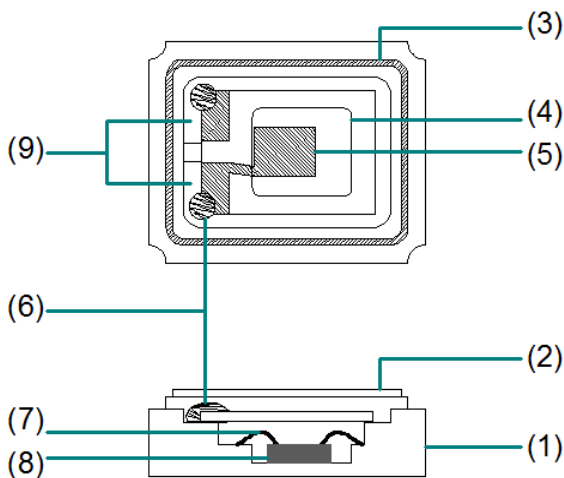

Reference drawing

No.	Component	Material	Note
1	Base-Ceramic	Ceramic	Al <sub>2</sub> O <sub>3</sub>
2	Lid	Fe- Ni -Co	Fe- Ni -Co
3	Kovar	Fe-Ni-Co	Fe-Ni-Co
4	Crystal Blank	Metal	SiO <sub>2</sub> Rectangular At-Cut
5	Electrode	Metal	-
6	Connective Adhesive	Silver Powder	Ag
7	Bonding Wire	Metal	Au
8	IC	Silicon	Si, Al
9	Pad	Metal	W Ni-Plating Au-Plating

※The use prohibition chemistry substance of Table 1 of DHE-0204-1 (HE-QA-24) is not included in this item.

### 5. HANDLING SUGGESTION

#### ■ Reflow Condition

Please stay with our proposed reflow condition and do soldering within 2 times.

(1)	Preheat	160~180deg.C	120 sec.
(2)	Primary heat	>=220 deg.C	100±20 sec.
(3)	Peak	260±5 deg.C	10 sec. Max.

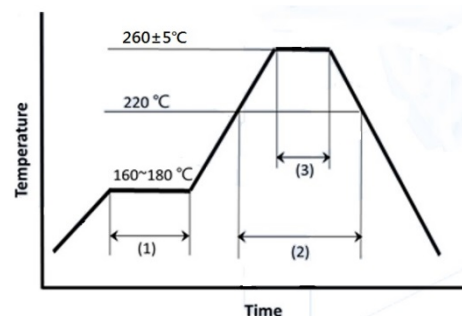

## HARMONY ELECTRONICS CORPRATION

KAOHSIUNG

TAIPEI

THAILAND

SHENZHEN

DONGGUAN

TEL: 886-2-26588883

Email: [contactus@hele.com.tw](mailto:contactus@hele.com.tw)



#### ■ Manual Solder iron (Example)

Bit temp.: 350°C max., Time: 3sec max. , Each terminal only should be soldered once.

#### ■ Mounting Conditions

Our products are suitable for most automated SMT processes. However, we strongly advise all our customers to conduct SMT sampling prior to mass production in order to make sure production processes will not affect the properties and specifications of our product. Seal welding and mounting procedures involving the use of ultra-sonic processes are not recommended and will affect and/or damage the internal properties of our product. Excessive shock during the mounting process will also affect the product and we strongly recommend setting SMT conditions to minimize such conditions.

If a possibility of the PCB being warped exists we strongly advise to ensure the degree of warping will not affect the product.

Please also ensure the operating characteristics and or soldering conditions are all within the specifications of use for our product.

Ultimately the worst case scenario of all the above will lead to cases of non-oscillation but other negative effects are also likely should our products be used in an inappropriate way. Please note such cases of misuse and its related quality issues are not included in our product warranty.

#### ■ Cleansing Conditions

General cleaning solutions may be used to clean our products but we always recommend testing to be performed prior to mass production processes. Ultrasonic cleaning procedures are not recommended and we strongly advise other forms of cleansing to be evaluated first. Unsuitable cleansing may lead to a number of negative effects such as damage to the product surface, discoloration of the product, corrosion of the package, package contamination, illegible marking, etc. Please note cases of unadvised treatment and its related quality issues are not included in our product warranty.

#### ■ Storage Conditions

Please ensure our products are preserved appropriately in their original packaging. Irregular environmental instances of moisture will affect our product's stability and may cause problems such as frequency instability, soldering ability and conditions, package defects, and other problems. It is essential to keep our products in a clean dust-free environment out of direct sunlight.

Our products' storage conditions should at least meet the following condition:

Environmental Temperature: + 40 degrees Celsius Maximum

Relative Humidity: 80% Maximum

**Please note storage instances which do not conform to our guidelines and the related quality issues produced as an outcome are not included in our product warranty.**

## HARMONY ELECTRONICS CORPORATION

KAOHSIUNG

TAIPEI

THAILAND

SHENZHEN

DONGGUAN

TEL: 886-2-26588883

Email: [contactus@hele.com.tw](mailto:contactus@hele.com.tw)



## 6. EMOSS CARRIER TAPE AND REEL

### Carrier Tape

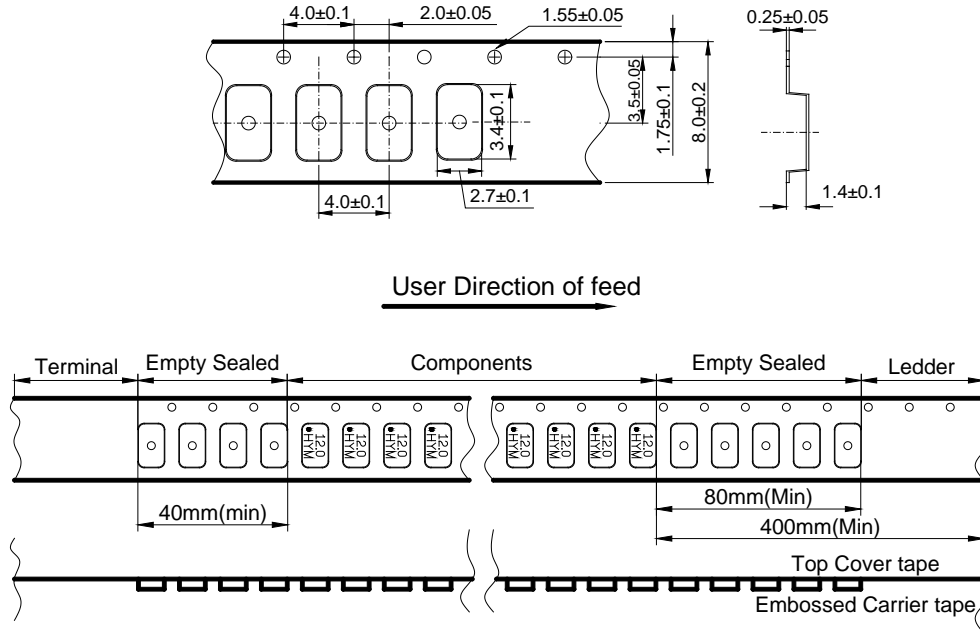

### Reel

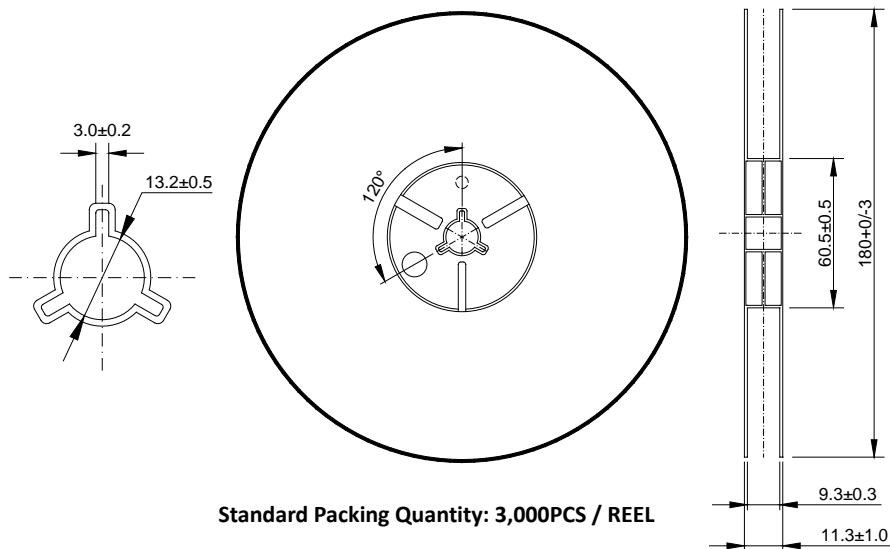

### Material of The Tape

Tape	Material
Carrier tape	PS Conductive
Top tape	PET

### Joint of tape

The carrier-tape and top cover-tape should not be jointed.

## HARMONY ELECTRONICS CORPRATION

KAOHSIUNG

TAIPEI

THAILAND

SHENZHEN

DONGGUAN

TEL: 886-2-26588883

Email: [contactus@hele.com.tw](mailto:contactus@hele.com.tw)





■ **Release strength of cover tape**

The force should be controlled between 0.1N to 0.7N under following condition.

Pulling direction: 165° to 180°

Speed: 300mm/min.

Otherwise unless specified.

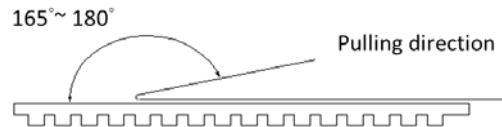

Other standards shall be based on JIS C 0806-1990.

**7. PACKAGE**

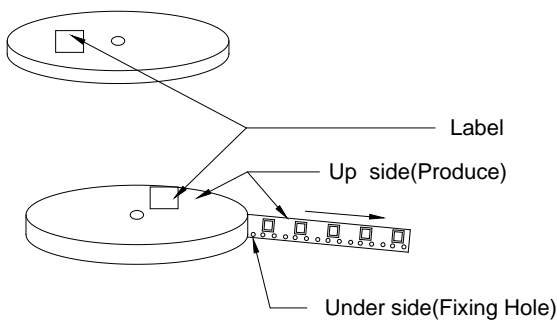

One reel quantity: [1000pcs]&[3000pcs]

**Label Contents**

TYPE:  
SPEC. No.:  
Parts No.:  
Lot No.:

FREQ.:                      MHz  
Q'TY:                        PCS

HARMONY ELECTRONICS CORP.

HSF

The label will be stickled on all reels.

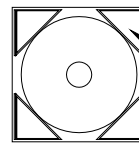

use 4 trigon pilla

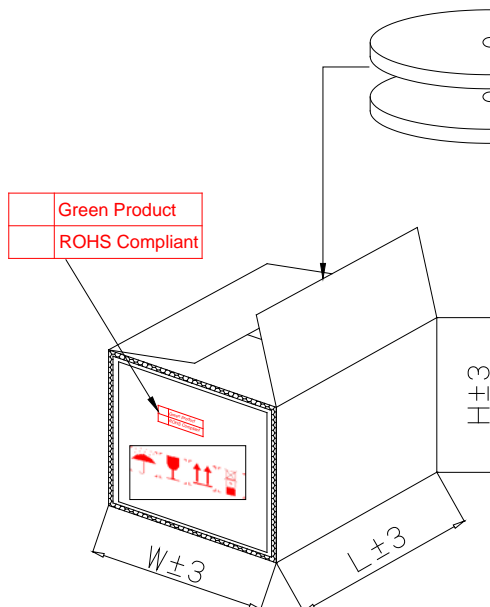

Carton Type	A	B	C	D
Produce Type	840/751	630/531/ 421	321/221 211/111	OTHER
Reel	15	15	15	1~7
L±3	200	200	200	195
W±3	200	200	200	195
H±3	230/260	230	230	150

- ① Top and bottom with 2.3cm thickness foam-rubber cushion for protection.
- ② Carton's Q'TY: 1~15 pcs.
- ③ Carton Type=A,B,C use 4 trigon pillar to fasten the Reel.
- ④ Need to add 3 pages dry agent in each outer box.

**HARMONY ELECTRONICS CORPRATION**

KAOHSIUNG

TAIPEI

THAILAND

SHENZHEN

DONGGUAN

TEL: 886-2-26588883

Email: [contactus@hele.com.tw](mailto:contactus@hele.com.tw)



## 8. MECHANICAL PERFORMANCE

Item		Test Methods	Specifications Code
1	Shock	Dropping from 50 cm height 3 times on 30mm Concrete Floor. Refer to: JIS C 60068-2-32	A
2	Vibration	Frequency 10-55Hz, Sine Wave full amplitude of 0.8mm to X, Y and Z 3 axes, Duration of 2 hours to each axis. Refer to: JIS C 60068-2-6/MIL-HDBK-781A 6.5.2	A
3	Leakage Test	Leak Rate $1.0 \times 10^{-9}$ Pa-m <sup>3</sup> /sec. Max. Measured by Helium leak detector. Refer to: JIS C 60068-2-17	---
4	Solder ability	After applying ROSIN Flux, dipping in solder bath at 245deg.C +/- 5deg.C for 3+/-0.5 sec. Refer to: JIS C 60068-2-20/C 60068-2-58	B

## 9. ENVIRONMENT PERFORMANCE

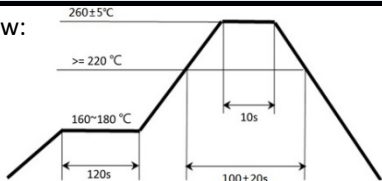
Item		Test Methods	Specifications Code
1	Resistance of Soldering Heat	Performing as the following reflow: Refer to: JIS C 60068-2-58 	A
2	Humidity	Temperature 60°C +/- 2°C, RH 90~95%, Duration of 240 hours. Back to the room temperature first, then check the component after 1~2 hours. Refer to: JIS C 60068-2-3	A
3	Storage in Low Temperature	-40deg.C +/- 2deg.C, Duration of 240 hours. Back to the room temperature first, then check the component after 1~2 hours. Refer to: JIS C 60068-2-1	A
4	Storage in High Temperature	+85deg.C +/- 2deg.C, Duration of 240 hours. Back to the room temperature first, then check the component after 1~2 hours. Refer to: JIS C 60068-2-2	A
5	Thermal shock	-40deg.C +/- 2deg.C (30min) ↔ +85deg.C +/- 2deg.C (30min) 25 cycles. And Temperature Increasing/reducing time ≤ 3mins. Back to the room temperature first, then check the component after 1~2 hours. Refer to: JIS C 0025	A

Specifications code	Specifications
A	Frequency variation shall be within +/-5ppm
B	More than 90% of lead shall be covered by new solder.

# HARMONY ELECTRONICS CORPRATION

KAOHSIUNG

TAIPEI

THAILAND

SHENZHEN

DONGGUAN

TEL: 886-2-26588883

Email: [contactus@hele.com.tw](mailto:contactus@hele.com.tw)

## **FACTORY LOCATION**

### **HEAD OFFICE/TAIWAN FACTORY**

NO.39, HUADONG RD., DALIAO DIST., DAFA INDUSTRIAL PARK, KAOHSIUNG CITY 831.

### **CHINA FACTORY**

SHEN ZHEN

JU YUAN INDUSTRIAL PARK, QIAO TANG ROAD, TANG WEI COMMUNITY, FUYONG, BAOAN DISTRICT, SHEN ZHEN CITY (Post Code:518103).

DONGGUAN

BUILDING A1, HUAZHI INDUSTRIAL PARK, NO.38, JINGFU EAST ROAD, DALANG TOWN, DONGGUAN CITY.

### **THAILAND FACTORY**

66MOO 5, KAONGU-BEOKPRAI RD., T.BEOKPRAI, A. BANPONG, RATCHABURI PROVINCE 70110.

## **SERVICE CENTER**

### **TAIPEI OFFICE**

2F., NO.409, SEC.2, TIDING BLVD., NEIHU DISTRICT, TAIPEI CITY 114, TAIWAN  
TEL: 886-2-26588883  
FAX: 886-2-26588683

### **CONTACT INFORMATION**

E-MAIL: [contactus@hele.com.tw](mailto:contactus@hele.com.tw)



**加高電子股份有限公司**  
**HARMONY ELECTRONICS CORP.**



单击下面可查看定价，库存，交付和生命周期等信息

[>>HELE\(加高\)](#)