

SPECIFICATIONS FOR APPROVAL



Customer Part No. _____ HELE. Part No: **X3S032000BA1H-R**
Application For: _____ Products: **CRYSTAL**
Accepted Model: _____ Type & Freq.: **HSX321S / 32.000MHz**
Sample Order No: **EOS-E30362-2** Date: **2014/04/03**

Approved By :

加高電子股份有限公司

HARMONY ELECTRONICS CORP.

HARMONY ELECTRONICS (THAILAND) CO., LTD.

HARMONY ELECTRONICS (SHENZHEN) CORP., LTD.

HARMONY ELECTRONICS (SUZHOU) CO.,LTD

TAIPEI OFFICE:

公司:(114)
台北市內湖區堤頂大道2段409號
2樓
2F., NO.409, SEC.2, TIDING
BLVD., NEIHU DISTRICT,
TAIPEI CITY 114, TAIWAN
TEL:886-2-26588883
FAX:886-2-26588683

TAIWAN FACTORY:

工廠:(831)
高雄市大寮區大發工業區華東路
39號
No.39, HWA DONG RD.,
DALLIAO DIST.,DAFA
INDUSTRIAL PARK.,
KAOHSIUNG CITY 831, TAIWAN
TEL: (07)787-1555-6
FAX: (07)787-1557

THAILAND FACTORY:

66MOO 5, KAONGU-BEOKPRAI
RD., T.BEOKPRAI, A. BANPONG,
RAJCHABUREE PROVINCE
70110, THAILAND
TEL: (032)221994-6,
200740-1
FAX: (032)200742

SHENZHEN FACTORY:

深圳市福永鎮塘尾村塘橋路聚源
工業區
QIAO TANG RD., TANGWEI
VILLAGE FU YONG TOWN
SHENZHEN CITY CHINA
TEL: 0755-27309272 /
27309262
FAX: 0755-27309755

SUZHOU FACTORY:

蘇州市相城區黃埭鎮安民路5號
NO.5 ANMING ROAD,
HUANGDAI TOWN,
XIANGCHENG DISTRICT,
SUZHOU CITY, JIANGSU
PROVINCE
TEL:86-512-67592373
FAX:86-512-67592363

Title HSX321S QUARTZ CRYSTAL SPECIFICATION				Country of origin TAIWAN FACTORY THAILAND FACTORY CHINA FACTORY		
Date	Confirm	Check	Prepare	Spec. No.	Rev.	Page
2014/04/03	F. S. TSAI	Y. W. LEE	U. F. CHEN	X3S032000BA1H-R	0	1

HARMONY ELECTRONICS CORP.

HSX321S SPECIFICATION

INDEX

ITEM	PAGE
1. QUARTZ CRYSTAL UNIT SPECIFICATION	3
2. MARKING & DIMENSIONS	4
3. INSIDE STRUCTURE	5
4. EMBOSS CARRIER TAPE&REEL	
a. DIMENSIONS OF CARRIER TAPE	6
b. DIMENSIONS OF REEL	6-7
c. STORAGE CONDITION	7
d. STANDARD PACKING QUANTITY	7
e. MATERIAL OF TAPE	7
f. LABEL CONTENTS	7
g. TAPING DIMENSION	8
h. JOINT OF TAPE	8
i. RELEASE STRENGTH OF COVER TAPE	8
j. PACKAGE	9
5. MECHANICAL PERFORMANCE	10
6. ENVIRONMENTAL PERFORMANCE	11
7. SUPPLEMENT	12-13
8. FLOW CHART	14
9. Environmental Workload Chemical Substance Components List .	15
10. TEST DATA	

Title HSX321S QUARTZ CRYSTAL SPECIFICATION				Country of origin TAIWAN FACTORY THAILAND FACTORY CHINA FACTORY		
Date	Confirm	Check	Prepare	Spec. No.	Rev.	Page
2014/04/03	F. S. TSAI	Y. W. LEE	U. F. CHEN	X3S032000BA1H-R	0	2

1. QUARTZ CRYSTAL UNIT SPECIFICATION

- | | |
|--------------------------------|---|
| 1. Frequency: | 32.000000MHz |
| 2. Holder type : | HSX321S |
| 3. Frequency tolerance: | +/-10 ppm at 25deg.C +/-3deg.C |
| 4. Equivalent resistance: | 80 ohms Max. / SERIES |
| 5. Storage temperature range: | -40 deg.C To +125 deg.C |
| 6. Operable temperature range: | -20 deg.C To +75 deg.C |
| 7. Temperature drift: | +/-10 ppm -20 deg.C To +75 deg.C |
| 8. Loading capacitance (CL) : | 10.0 pF |
| 9. Drive level: | 10 μ W (100uW Max) |
| 10. Shunt Capacitance: | 2.0 pF Max |
| 11. Insulation resistance : | More than 500M ohms at DC 100V |
| 12. Mode of oscillation: | Fundamental |
| 13. Circuit: | Measured in HP/E5100A,S&A 250B |
| 14. Shocking : | Dropping from 120 cm height 3 times on Concrete floor |
| Variation : | Frequency less than +/-5 ppm
Resistance less than +/- 15 % or 2ohms max. |
| 15. Aging: | Less than +/-3 ppm/Year |
| 16. Holder | HSX321S Seam type |
| 17. Dimensions and marking | Refer to page.4 |
| 18. Emboss carrier tape & reel | Refer to page.6 and page.7 |
| 19. Moisture Sensitivity Level | Level 1 |
| 20. Note: | |

Title HSX321S QUARTZ CRYSTAL SPECIFICATION				Country of origin TAIWAN FACTORY THAILAND FACTORY CHINA FACTORY		
Date 2014/04/03	Confirm F. S. TSAI	Check Y. W. LEE	Prepare U. F. CHEN	Spec. No. X3S032000BA1H-R	Rev. 0	Page 3

3. INSIDE STRUCTURE

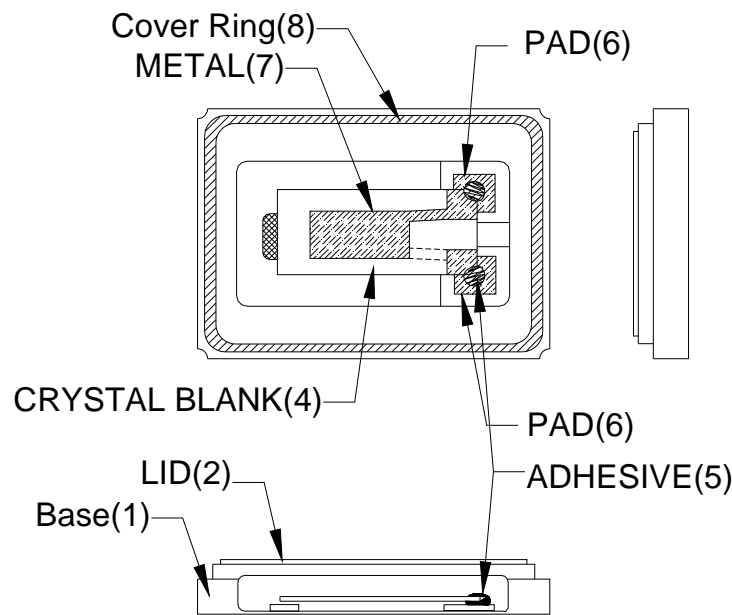

※Reference drawing

(1) Base: Alumina Ceramic (Al_2O_3)
(6) Metallized Pad: W Ni Plating Au Plating
(2) Lid : Fe- Ni -Co
(3) Crystal Enclosure Seal: Seal Seam
(4) Crystal Blank Rectangular At-Cut Quartz Crystal Blank
(5) Adhesive Silver Conductive Silicon Resin Adhesive bonding: upper & lower bonding/lower bonding only
(7) Metal
(8) Cover Ring : Fe-Ni-Co Alloy

The use prohibition chemistry substance of Table 1 of DHE-0204-1 (HE-QA-24) is not included in this item.

Title HSX321S QUARTZ CRYSTAL SPECIFICATION				Country of origin TAIWAN FACTORY THAILAND FACTORY CHINA FACTORY		
Date	Confirm	Check	Prepare	Spec. No.	Rev.	Page
2014/04/03	F. S. TSAI	Y. W. LEE	U. F. CHEN	X3S032000BA1H-R	0	5

4. HSX321S EMBOSS CARRIER TAPE & REEL

a.) Dimensions of Carrier Tape

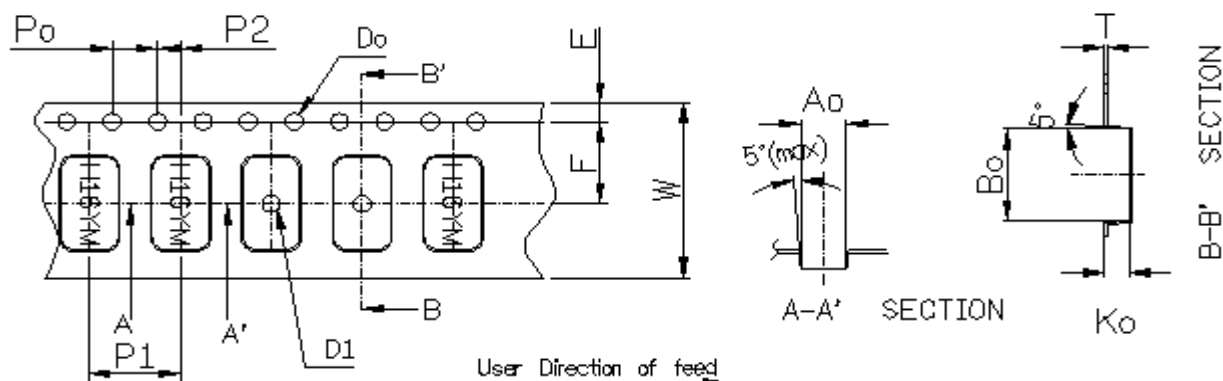

Symbol	Ao	Bo	Ko	Po	P1	P2
Spec	2.70±0.1	3.4±0.1	1.40±0.1	4.0±0.1	4.0±0.1	2.0±0.05
Symbol	E	F	Do	D1	W	T
Spec	1.75±0.1	3.5±0.05	∅1.55±0.05	∅1.0(min)	8.0±0.2	0.25±0.05

b.) Dimensions of Reel

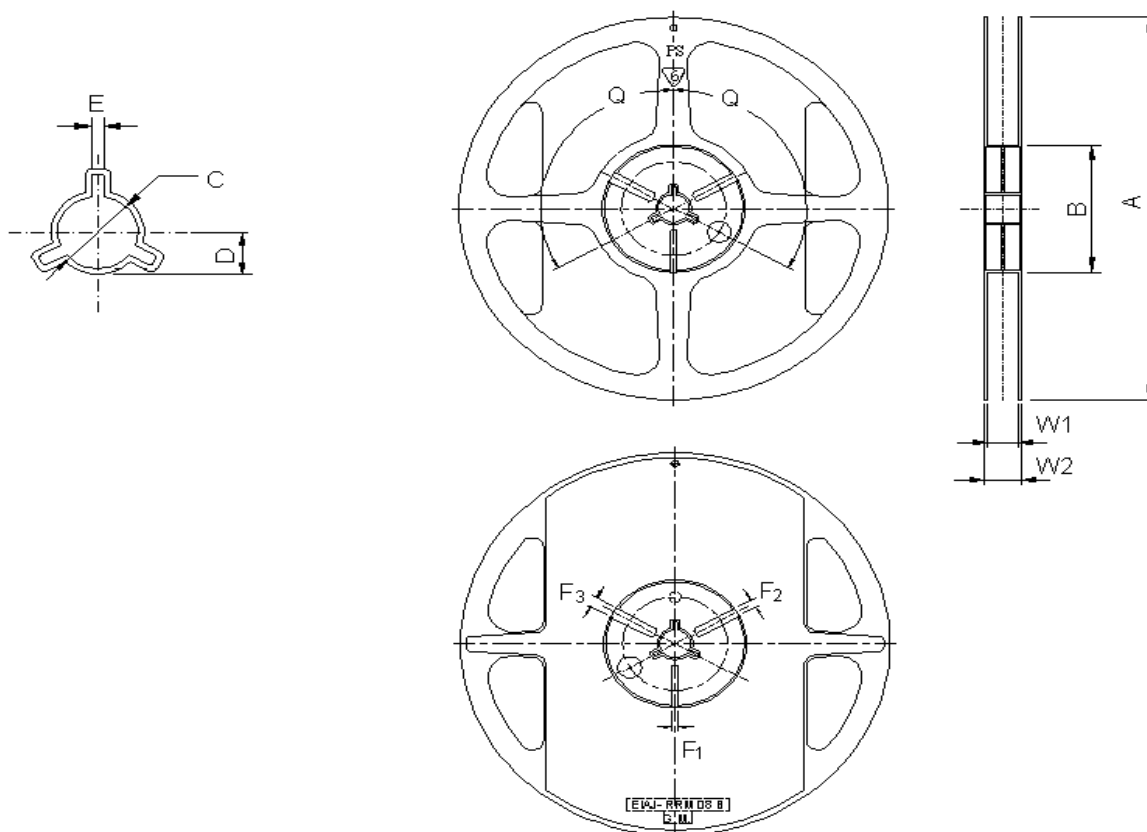

Title HSX321S QUARTZ CRYSTAL SPECIFICATION				Country of origin TAIWAN FACTORY THAILAND FACTORY CHINA FACTORY		
Date	Confirm	Check	Prepare	Spec. No.	Rev.	Page
2014/04/03	F. S. TSAI	Y. W. LEE	U. F. CHEN	X3S032000BA1H-R	0	6

(Table-2)

(UNIT: mm)

ITEM		MARK	DIMENSIONS • ANGLE	
FLANCE	Diameter	A	$\psi 180+0/-3$	
	Inner Width	W1	$9.3+/-0.3$	
	Outer Width	W2	$11.3+/-1.0$	
HUB	Out Line diameter		B	$\psi 60.5+/-0.5$
	Center Core slit	Width	F1	$3.0+0.5/-0$
			F2	$4.0+0.5/-0$
			F3	$5.0+0.5/-0$
	Position		Q	120deg
	Spindle diameter		C	$\psi 13.2+/-0.5$
Key Ditch	Width	E	$3.0+/-0.2$	

c.) Storage condition

Temperature: +40deg.C Max.

Relative Humidity: 80% Max.

d.) Standard packing quantity

3,000PCS / REEL

e.) Material of the tape

Tape	Material
Carrier tape	PS Conductive
Top tape	Polyester

f.) Label contents

	
TYPE:	
SPEC.No.:	
Parts No.:	
LotNo.:	
FREQ.:	MHz
Q'TY:	PCS
HARMONY ELECTRONICS CORP. (H.ELE.) HSF	

Sticks label for every reel.

Title HSX321S QUARTZ CRYSTAL SPECIFICATION				Country of origin TAIWAN FACTORY THAILAND FACTORY CHINA FACTORY		
Date	Confirm	Check	Prepare	Spec. No.	Rev.	Page
2014/04/03	F. S. TSAI	Y. W. LEE	U. F. CHEN	X3S032000BA1H-R	0	7

HARMONY ELECTRONICS CORP.

g.) Taping dimension

Leader	Cover-tape	The length of cover-tape in the leader is more than 400 mm including empty embossed area.
	Carrier-tape	After all products were packaged, must remain more than twenty pieces or 400 mm empty area, which should be sealed by cover-tape.
Terminal	Cover-tape	The tip of cover-tape shall be fixed temporary by paper tape and roll around the core of reel one round.
	Carrier-tape	The empty embossed area which are sealed by top cover-tape must remain more the 40 mm.



h.) Joint of tape

The carrier-tape and top cover-tape should not be jointed.

i.) Release strength of cover tape

It has to between 0.1N to 0.7N under following condition.

Pulling direction 165° to 180°

Speed 300mm/min.

Otherwise unless specified.

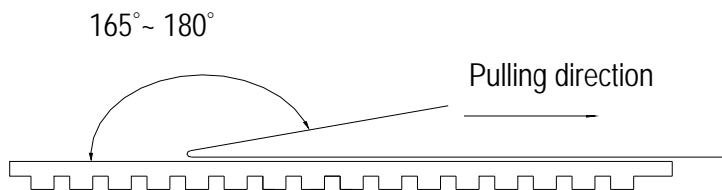

Other standards shall be based on JIS C 0806-1990.

Title HSX321S QUARTZ CRYSTAL SPECIFICATION				Country of origin TAIWAN FACTORY THAILAND FACTORY CHINA FACTORY		
Date	Confirm	Check	Prepare	Spec. No.	Rev.	Page
2014/04/03	F. S. TSAI	Y. W. LEE	U. F. CHEN	X3S032000BA1H-R	0	8

j.) Package

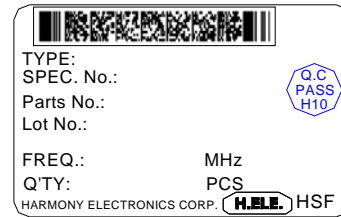
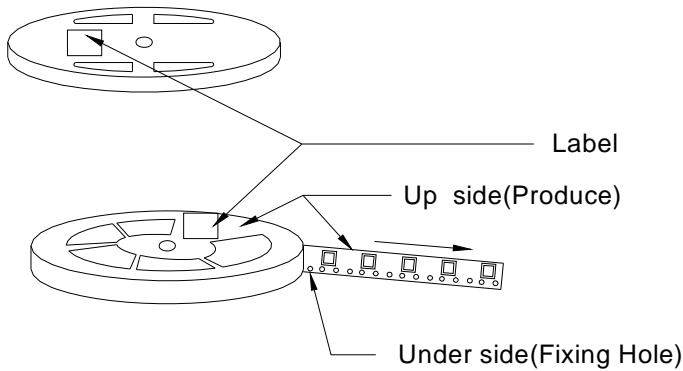

One reel quantity: [1000pcs]&[3000pcs]

- ① Top and bottom with 2.3cm thickness foam-rubber cushion for protection.
- ② Carton's Q'TY: 1~15 pcs.
- ③ Carton Type=A,B,C use 4 trigon pillar to fasten the Reel.
- ④ Need to add 3 pages dry agent in each outer box.

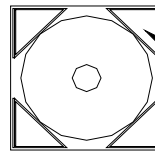

use 4 trigon pilla

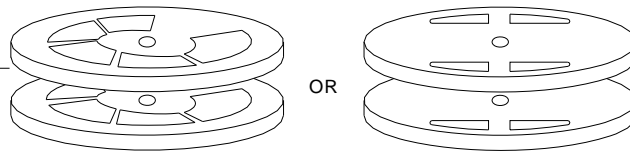

Green Product
ROHS Compliant

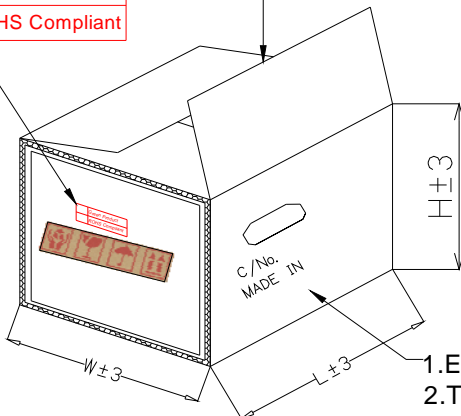

Carton Type	A	B	C	D
Produce Type	840/751	630/531/ 421	321/221/ 211/111	OTHER
Reel	15	15	15	1~7
L±3	200	200	200	195
W±3	200	200	200	195
H±3	230/260	230	230	150

1. Every Carton with 3 desiccant.
2. Top and bottom with 2.3cm thickness foam-rubber cushion for protection

Title **HSX321S**
QUARTZ CRYSTAL SPECIFICATION

Country of origin **TAIWAN FACTORY**
THAILAND FACTORY
CHINA FACTORY

Date	Confirm	Check	Prepare	Spec. No.	Rev.	Page
2014/04/03	F. S. TSAI	Y. W. LEE	U. F. CHEN	X3S032000BA1H-R	0	9

HARMONY ELECTRONICS CORP.

5. Mechanical Performance

Item		Test Methods	Specifications Code
1	Natural Drop	Dropping from 120 cm height 3 times on Concrete floor	A
2	Vibration	Frequency 10-55Hz, Sine Wave full amplitude of 0.8mm to X, Y and Z 3 axes, Duration of 120min. to each direction.	A
3	Sealing Tightness	Leak Rate 1.0×10^{-8} Pa-m ³ /sec. Max. Measured by Helium leak detector. – Fine Leakage.	---
4	Solderability	After applying ROSIN Flux, dipping in solder bath at 245deg.C +/- 5deg.C for 3 +/- 0.5 sec.	B
5	Substrate Bending	Mount a sample on board. Apply Pressure to the center of board until it is bent to 3 mm and hold for 5 ± 1 sec Pressure speed : 0.5 mm / sec	A
6	Adhesion	Mount a sample on the circuit board. Apply pressure vertically to the side of specimen attached to the circuit board with the pressure jig. Pressure : 5N for 10 +/- 1 sec	A
7	Body strength	Apply pressure to the center of body with the R0.5 pressure jig. pressure : 10N for 10 +/- 1 sec	A

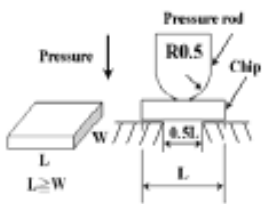
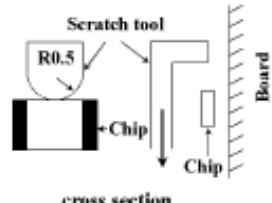
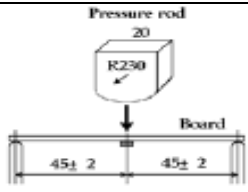

Title HSX321S QUARTZ CRYSTAL SPECIFICATION				Country of origin TAIWAN FACTORY THAILAND FACTORY CHINA FACTORY		
Date	Confirm	Check	Prepare	Spec. No.	Rev.	Page
2014/04/03	F. S. TSAI	Y. W. LEE	U. F. CHEN	X3S032000BA1H-R	0	10

6. Environment Performance

Item		Test Methods	Specifications Code
1	Humidity	Temperature 60°C +/-2°C, RH 90~95%, Duration of 240 hours. Back to room temperature first, then in 1~2 hours, the component shall be checked.	A
2	Storage in Low Temperature	-40deg.C +/-2deg.C, Duration of 240 hours. Back to the room temperature first, then in 1~2 hours, the component shall be checked.	A
3	Storage in High Temperature	+85deg.C +/-2deg.C, Duration of 240 hours. Back to the room temperature first, then in 1~2 hours, the component shall be checked.	A
4	Temperature cycles	-40deg.C +/-2deg.C (30min) ↔ +85deg.C +/-2deg.C (30min) 25 cycles. Back to the room temperature first, then in 1~2 hours, the component shall be checked.	A

Specifications code	Specifications
A	Frequency variation shall be within +/-5ppm and equivalent resistance shall be within +/-15% or 2Ω
B	More than 90% of lead shall be covered by new solder.

Title HSX321S QUARTZ CRYSTAL SPECIFICATION				Country of origin TAIWAN FACTORY THAILAND FACTORY CHINA FACTORY		
Date	Confirm	Check	Prepare	Spec. No.	Rev.	Page
2014/04/03	F. S. TSAI	Y. W. LEE	U. F. CHEN	X3S032000BA1H-R	0	11

7. Supplement

7.1.Soldering

7.2.Please stay with our proposed reflow condition and do then soldering 2 times max.

Available for Lead Free Soldering

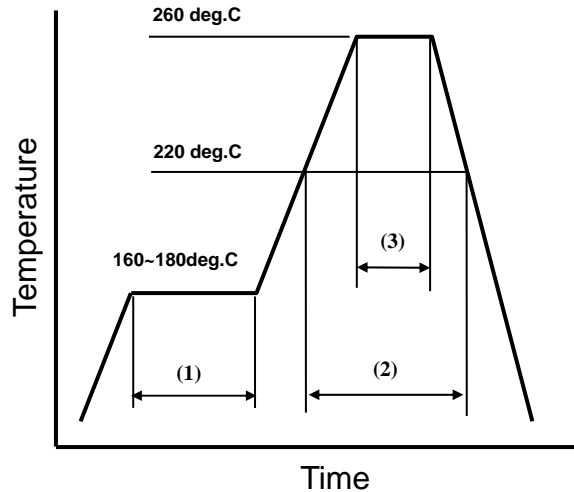

(1)	Preheat	160~180 deg.C	120sec.
(2)	Primary heat	220 deg.C	60sec.
(3)	Peak	260 deg.C	10sec. Max.

7.3.Land pattern layout(Example)

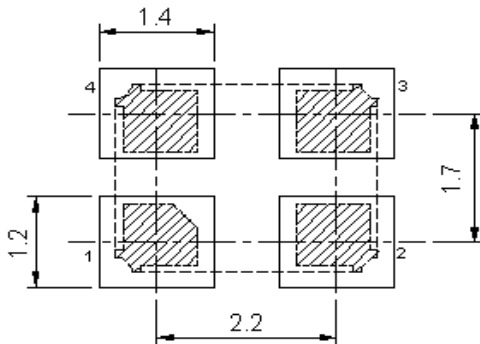

7.4.Solder iron (Example)

Bit temp.:350°C max.,Time:3sec max. ,Each terminal solder a 1 time max.

Title HSX321S QUARTZ CRYSTAL SPECIFICATION				Country of origin TAIWAN FACTORY THAILAND FACTORY CHINA FACTORY		
Date	Confirm	Check	Prepare	Spec. No.	Rev.	Page
2014/04/03	F. S. TSAI	Y. W. LEE	U. F. CHEN	X3S032000BA1H-R	0	12

HARMONY ELECTRONICS CORP.

7.5.Mounting

This component is designed for automatic insertion.

However, you are requested to do the trial with your insertion machine in order to be sure of proper operation and no damage of component.

Please pay attention to board warp which may damage the component and cause Soldering Process.

Avoid mounting and processing by Ultrasonic welding because this method has a possibility of an excessive vibration spreading inside the crystal products and becoming the cause of characteristic deterioration and not oscillating.

7.6.Cleaning

Cleaning liquid which corrodes Nickel shall not be used

It may cause the problem on the surface, color, marking etc.

Ultra-sonic cleaning is possible, however, you are requested to check on your board.

Because we only checked as single unit.

7.7.Storage

Please keep away from high temperature and high humidity ,which may cause put solderbility. No direct Sunlight, No dew as well.

Title HSX321S QUARTZ CRYSTAL SPECIFICATION				Country of origin TAIWAN FACTORY THAILAND FACTORY CHINA FACTORY		
Date	Confirm	Check	Prepare	Spec. No.	Rev.	Page
2014/04/03	F. S. TSAI	Y. W. LEE	U. F. CHEN	X3S032000BA1H-R	0	13

8. Flow Chart

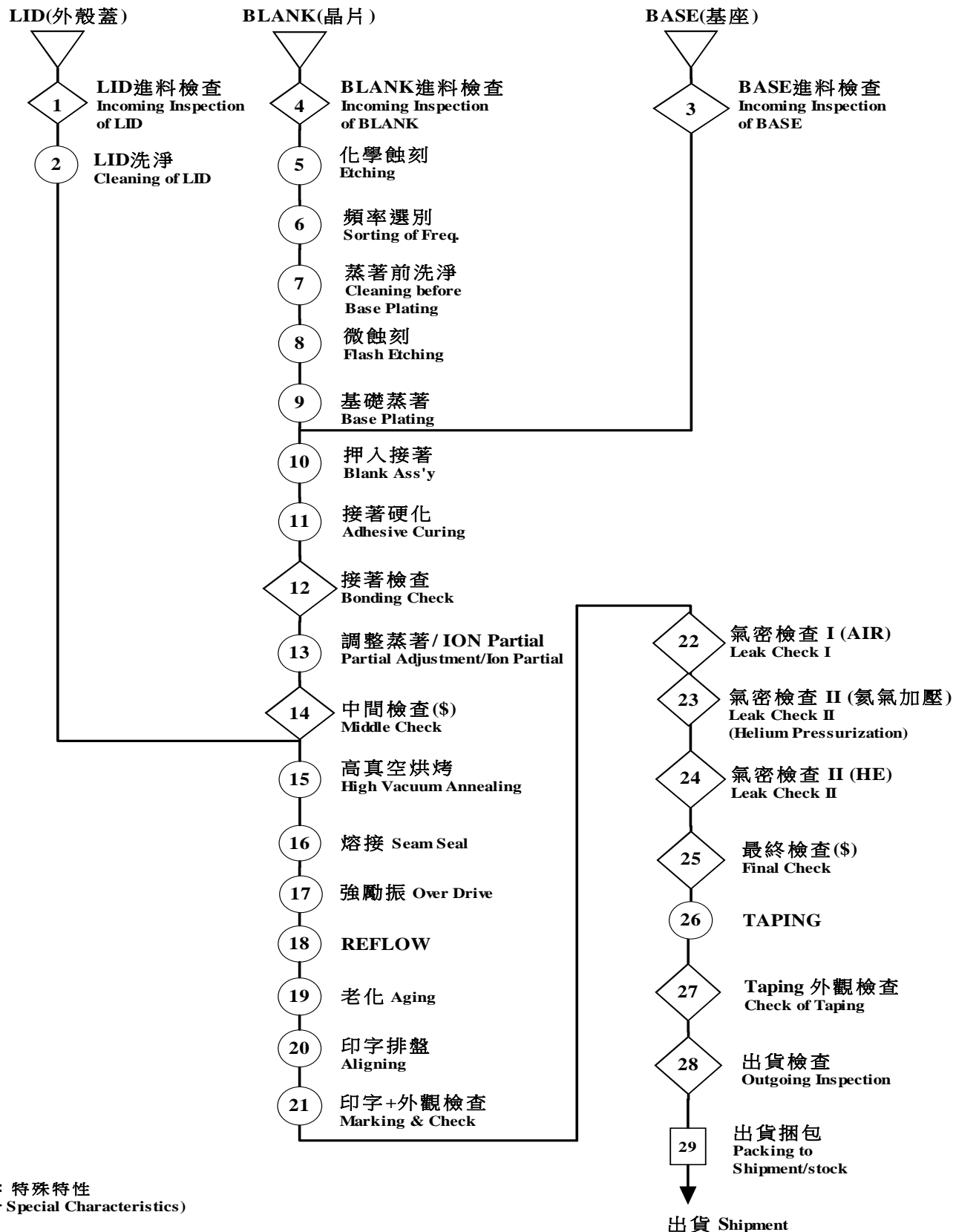

Title HSX321S QUARTZ CRYSTAL SPECIFICATION				Country of origin TAIWAN FACTORY THAILAND FACTORY CHINA FACTORY		
Date	Confirm	Check	Prepare	Spec. No.	Rev.	Page
2014/04/03	F. S. TSAI	Y. W. LEE	U. F. CHEN	X3S032000BA1H-R	0	14

9. Environmental Workload Chemical Substance Components List

Environmental Workload Chemical Substance Components List		
Chemical Substance Components	TYPE	H(D)SX321S
	PERCENTAGE	
		20.5(mg) ppm
Si		0.04715 9.6658
Au		0.15785 32.3593
Co & Co Compound		1.21770 249.6285
Mo & Mo Compound		0.04100 8.4050
Ag		0.42640 87.4120
Cu		0.11890 24.3745
Cr & Cr Compound		0.04100 8.4050
Al		5.09630 1044.7415
Mn & Mn Compound		0.02460 5.0430
W & W Compound		0.19885 40.7643
Ni & Ni Compound		3.06680 628.6940
Fe		4.14715 850.1658

Title HSX321S QUARTZ CRYSTAL SPECIFICATION				Country of origin TAIWAN FACTORY THAILAND FACTORY CHINA FACTORY		
Date	Confirm	Check	Prepare	Spec. No.	Rev.	Page
2014/04/03	F. S. TSAI	Y. W. LEE	U. F. CHEN	X3S032000BA1H-R	0	15

单击下面可查看定价，库存，交付和生命周期等信息

[>>HELE\(加高\)](#)