

Features::

H2TCP-2-33W+

- ◆ 50Ω Characteristic Impedance
- ◆ Frequency: 50to4000MHz
- ◆ Power Input(as a splitter): 0.50W Max
- ◆ DC current: 30mA
- ◆ Operating temperature range: -40°C to +85°C
- ◆ Storage temperature range: -55°C to +100°C

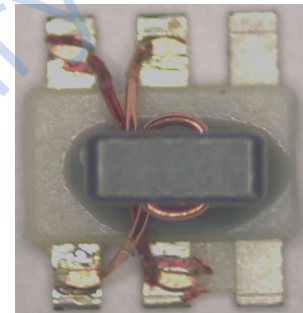

50-4000MHz

50 2 Way-0° Power Divider

Applications:

- ◆ For CATV broadband applications
- ◆ For VHF/UHF receivers/transmitters and push-pull amplifiers

Dimension Diagram (Unit:±0.20mm) :

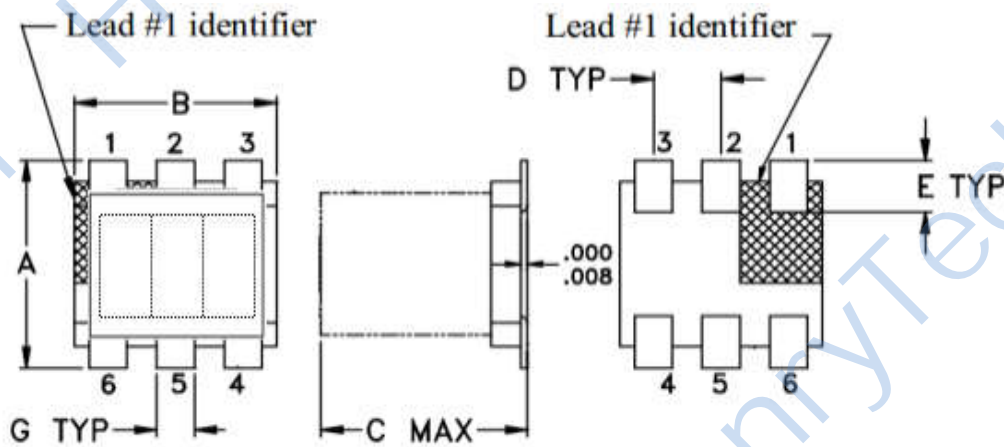

A=4.20±0.20 B=3.80±0.20 C=2.80±0.20 D=1.27±0.05 E=1.00±0.05

Electrical structure:

Recommended layout:

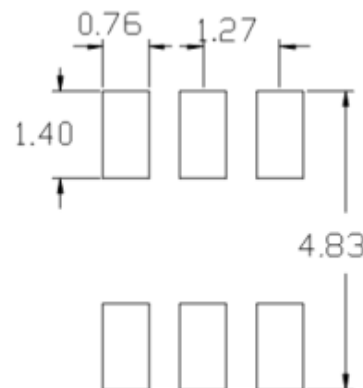
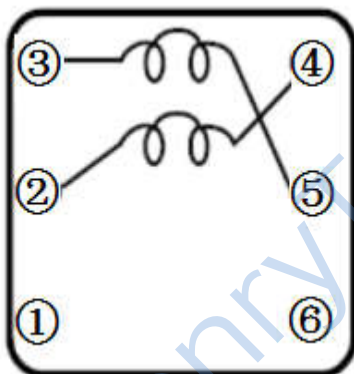

**Pin configuration:**

SUM PORT	6,5,2
PORT 1	3
PORT 2	4
GROUND	1
EXT. RESISTOR 475Ω	3,4

**Application circuit :**

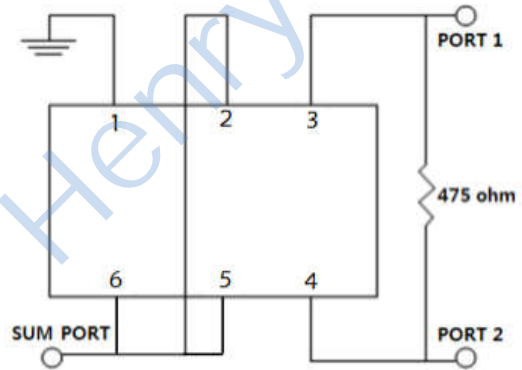

**Electrical Specifications: TA=25°C, 0dBm, Z0=50Ω**

Parameter	Test Conditions	Units	Min	Typ	Max
Main line Loss(out1)	50-4000MHz	dB	—	3.0	5.5
Main line Loss(out2)	50-4000MHz	dB	—	2.5	5.0
Amplitude balance	50-4000MHz	dB	—	1.0	1.5
Phase Balance	50-4000MHz	dB	—	8.0	12.0
Output 1 SWR	50-4000MHz	dB	—	2.0	3.5
Isolation	50-4000MHz	dB	10.0	20.0	—

**Recommended Soldering Temperature Graph:**

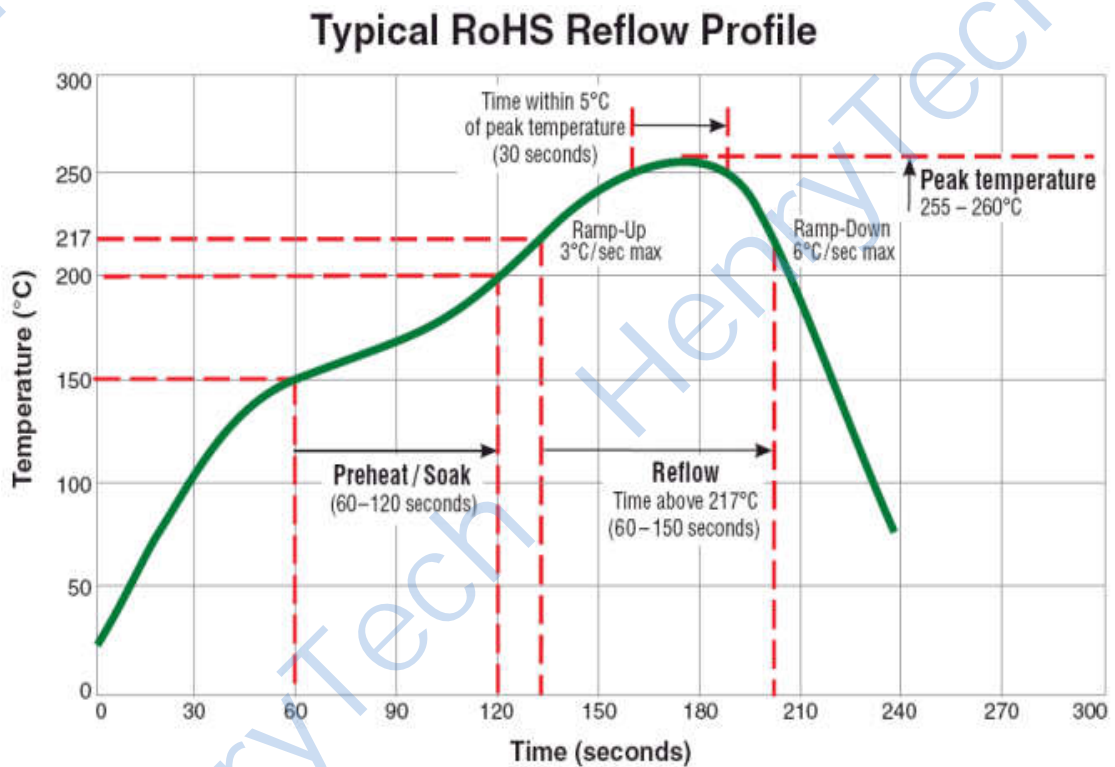

## Power Splitter/Combiner

Main line Loss(port1)

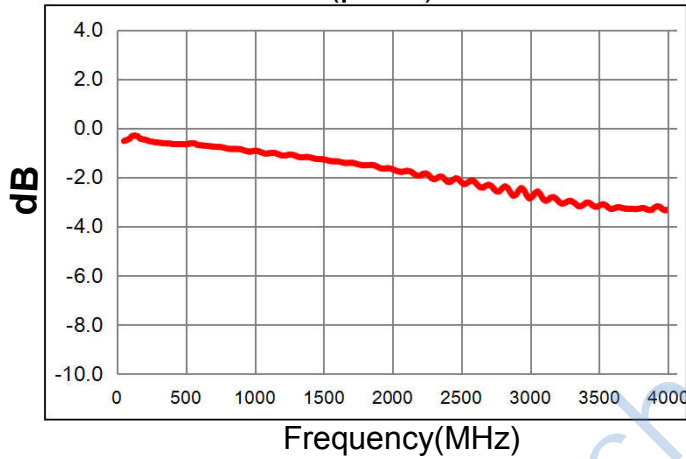

Main line Loss(port2)

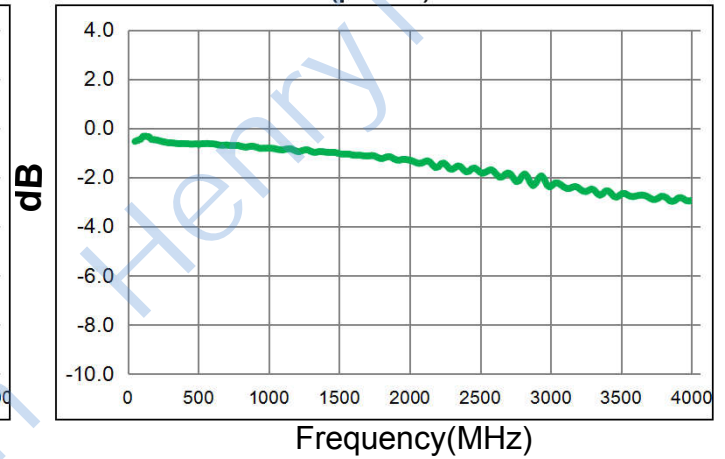

Amplitude balance

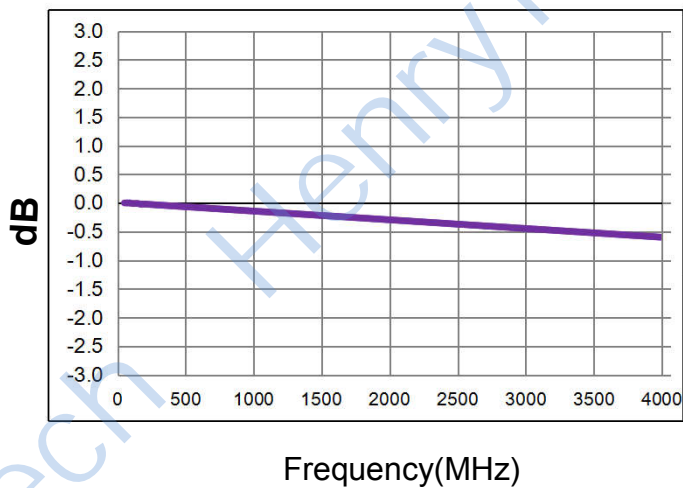

Phase Balance

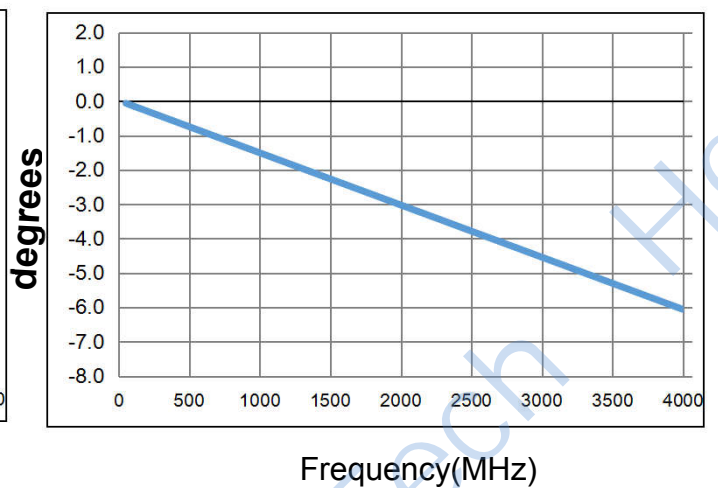

VSWR(Port S)

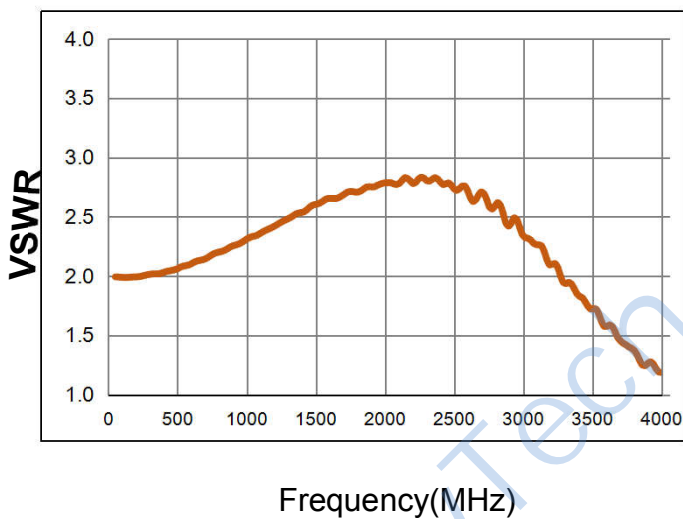

Isolation

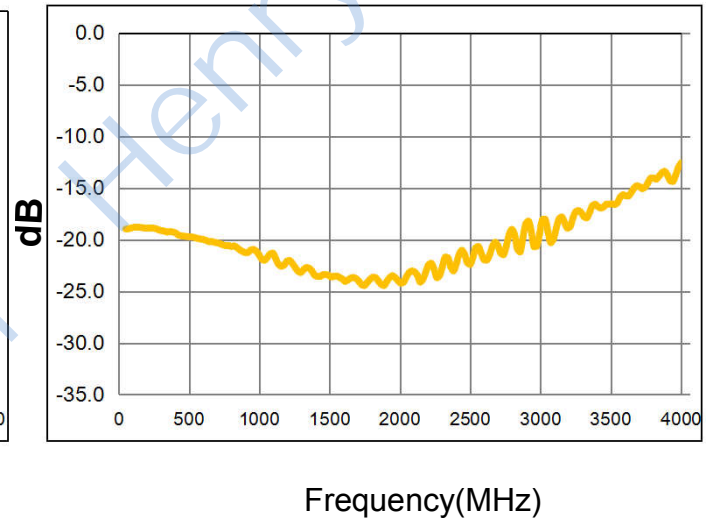

单击下面可查看定价，库存，交付和生命周期等信息

[>>HenryTech\(恒利泰\)](#)