

Low Pass Filter

Features

- excellent power handling
- small size
- 7 sections
- temperature stable
- LTCC construction

Applications

- harmonic rejection
- VHF/UHF transmitters/receivers

HT-LFCN-225+

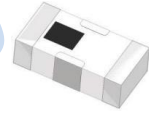

50Ω DC to 225 MHz

Maximum Ratings

Operating Temperature	-55°C to 100°C
Storage Temperature	-55°C to 100°C
RF Power Input*	10W max. at 25°C

* Passband rating, derate linearly to 3.5W at 100°C ambient.
Permanent damage may occur if any of these limits are exceeded.

Typical Frequency Response

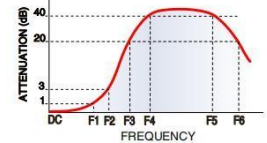

Electrical Schematic

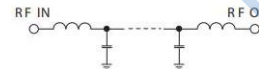

Outline Drawing

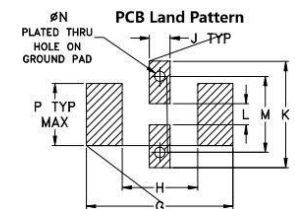
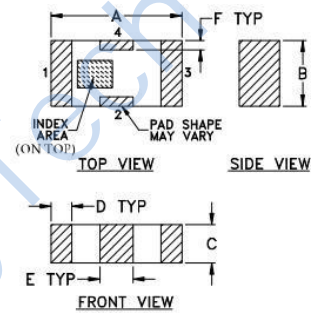

Suggested Layout
Tolerance to be within ±0.02

Outline Dimensions: Unit (mm)

A	3.20	B	1.60	C	0.94
D	0.51	E	0.81	F	0.23
G	4.29	H	2.21	J	0.61
K	3.10	L	0.61	M	2.21
N	0.30	P	1.80	wt	0.02g

Electrical Specifications at 25°C

Parameter		F#	Frequency(MHz)	Min.	Typ.	Max.	Unit
Pass Band	Insertion Loss	DC-F1	DC-225	-	-	1.2	dB
	Freq.Cut-Off	F2	350	-	3.0	-	dB
	VSWR	DC-F1	DC-225	-	1.2	-	:1
Stop Band	Rejection Loss	F3	460	20	-	-	dB
		F4-F5	510-2500	-	40	-	dB
	VSWR	F6	5500	-	20	-	dB
		F3-F6	460-5500	-	17	-	:1

Typical Performance Data

(TEST CONDITIONS: INPUT POWER = 0dBm @Temperature = +25°C)

Frequency (MHz)	Insertion Loss (dB)	VSWR (:1)
1	0.12	1.03
100	0.32	1.02
225	0.74	1.16
240	0.83	1.19
425	21.57	10.78
450	32.98	11.98
460	62.62	12.16
495	32.08	12.52
510	31.97	12.56
610	48.51	13.12
900	39.76	25.24
1400	39.84	52.14
2500	40.77	66.83
3220	52.29	77.73
5500	27.81	56.03

Suggested PCB Layout

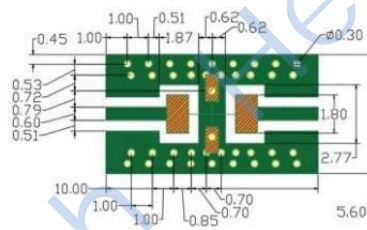

- NOTES:
1. COPLANAR WAVEGUIDE PARAMETERS ARE SHOWN FOR ROGERS RO4350 WITH THICKNESS 508" ± .0015". COPPER: 1/2 OZ. EACH SIDE. FOR OTHER MATERIALS TRACE WIDTH & GAP MAY NEED TO BE MODIFIED.
 2. BOTTOM SIDE OF THE PCB IS CONTINUOUS GROUND PLANE.
 - DENOTES PCB COPPER LAYOUT WITH SMOBC (SOLDER MASK OVER BARE COPPER)
 - DENOTES COPPER LAND PATTERN FREE OF SOLDER MASK

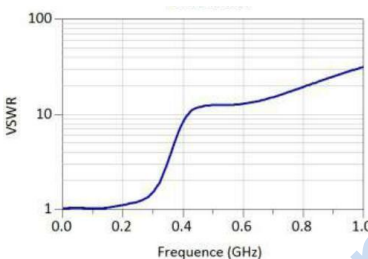
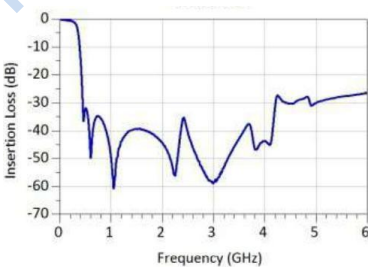

单击下面可查看定价，库存，交付和生命周期等信息

[>>HenryTech\(恒利泰\)](#)