

Quad Single Supply Comparator

The LM2901 consists of four independent precision voltage comparators with an offset voltage specification as low as 2.0 mV max for four comparators which were designed specifically to operate from a single power supply over a wide range of voltages.

Application areas include limit comparators, simple analog to digital converters; pulse, squarewave and time delay generators; wide range VCO; MOS clock timers; multivibrators and high voltage digital logic gates.

- * Single or Split Supply Operation
- * Low Input Bias Current
- * Low Input Offset Current
- * Input Common Mode Voltage Range to Gnd
- * Low Output Saturation Voltage
- * TTL and CMOS Compatible
- *

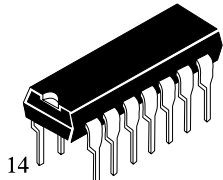

N SUFFIX
PLASTIC

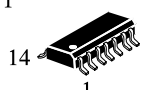

D SUFFIX
SOIC

ORDERING INFORMATION
LM2901N Plastic
LM2901D SOIC
T_A = 0° to 70° C for all packages.

LOGIC DIAGRAM

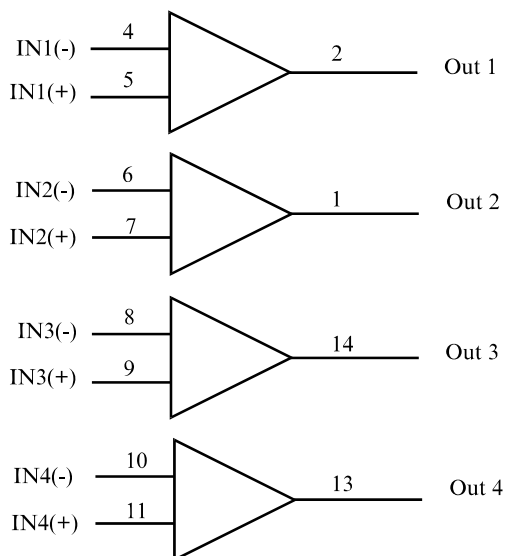

PIN 3 = V_{CC}
PIN 12 = GND

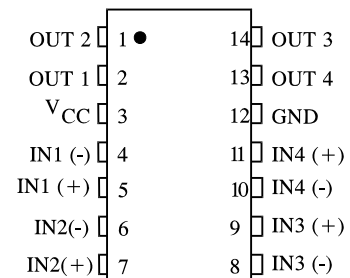

PIN ASSIGNMENT

MAXIMUM RATINGS*

Symbol	Parameter	Value	Unit
V _{CC}	Power Supply Voltages		
	Single Supply Split Supplies	36 ±18	V
V _{IDR}	Input Differential Voltage Range	36	V
V _{ICR}	Input Common Mode Voltage Range (1)	-0.3 to V _{CC}	V

I_{SC}	Output Short Circuit to Ground	Continuous	
I_{IN}	Input Current, per pin (2)	50	mA
T_J	Junction Temperature Plastic Packages	150	°C
T_{stg}	Storage Temperature	-65 to +150	°C
T_L	Lead Temperature, 1mm from Case for 10 Seconds	260	°C
P_D	Power Dissipation @ $T_A=25^{\circ}C$ Plastic Package Derate above 25°C	1.0 8.0	W mW/°C

*Maximum Ratings are those values beyond which damage to the device may occur.
 Functional operation should be restricted to the Recommended Operating Conditions.

Notes:

1. Split Power Supplies.
2. $V_{IN} < -0.3V$. This input current will only exist when voltage at any of the input leads is driven negative.

RECOMMENDED OPERATING CONDITIONS

Symbol	Parameter	Min	Max	Unit
V_{CC}	DC Supply Voltage	±2.5 or 5.0	±15 or 30	V
T_A	Operating Temperature, All Package Types	0	+70	°C

This device contains protection circuitry to guard against damage due to high static voltages or electric fields. However, precautions must be taken to avoid applications of any voltage higher than maximum rated voltages to this high-impedance circuit. For proper operation, V_{IN} and V_{OUT} should be constrained to the range $GND \leq (V_{IN} \text{ or } V_{OUT}) \leq V_{CC}$.

Unused inputs must always be tied to an appropriate logic voltage level (e.g., either GND or V_{CC}).
 Unused outputs must be left open.

DC ELECTRICAL CHARACTERISTICS (T_A=0 to +70°C)

Symbol	Parameter	Test Conditions	Guaranteed Limit			Unit
			Min	Typ	Max	
V _{IO}	Input Offset Voltage	V ₀ =1.4V V _{CC} =5.0-30V; R _S ≤100Ω V _{ICR} =0V - (V _{CC} -1.5)V	-		9.0	mV
I _{IB}	Input Bias Current	V ₀ =1.4V V _{CC} =5.0-30V V _{ICR} =0V - (V _{CC} -1.5)V	-		400	nA
I _{IO}	Input Offset Current	V ₀ =1.4V V _{CC} =5.0-30V V _{ICR} =0V - (V _{CC} -1.5)V	-		±150	nA
V _{ICR}	Input Common Mode Voltage Range	V _{CC} =5.0-30V	0		V _{CC} -2.0V	V
I _{CC}	Supply Current	R _L =∞, V _{CC} =5.0 R _L =∞, V _{CC} =30V	- -		2.0* 2.5*	mA
A _{VOL}	Voltage Gain	V _{CC} =15V, R _L =15KΩ	-	200*	-	V/mV
t ₁	Large Signal Response Time	V _{IN} =TTL Logic Swing, V _{ref} =1.4V, V _{CC} =5.0V, R _L =5.1KΩ, V _{RL} =5.0V	-	300*	-	ns
t ₂	Response Time	V _{CC} =5.0V, R _L =5.1KΩ, V _{RL} =5.0V	-	1.3*	-	μs
I _{sink}	Output Sink Current	V _{I(-)} =1.0V, V _{I(+)} =0V, V ₀ ≤1.5V, V _{CC} =5.0V	6.0*	-	-	mA
V _{sat}	Saturation Voltage	V _{I(-)} =1.0V, V _{I(+)} =0V, I _{sink} ≤4.0mA, V _{CC} =5.0V	-	-	700	mV
I _{OL}	Output Leakage Current	V _{I(+)} =1.0V, V _{I(-)} =0V, V ₀ =5.0V V ₀ =30V		0.1*	1000	nA
V _{IDR}	Differential Input Voltage Range	All V _{IN} ≥GND or V-Supply (if used)			V _{CC} *	V

*=@25°C

TYPICAL PERFORMANCE CHARACTERISTICS

($V_{CC}=1.5V$, $T_A=+25^{\circ}C$, (each comparator))

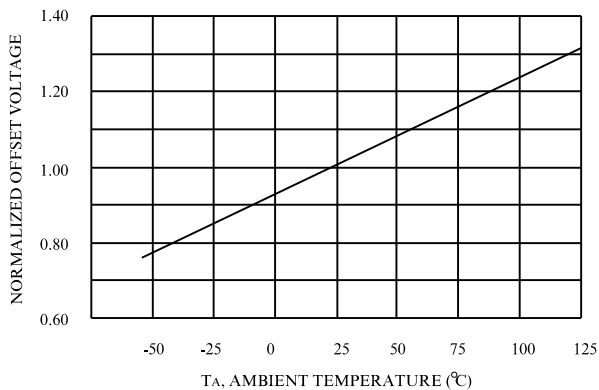

Figure 1. Normalized Input Offset Voltage

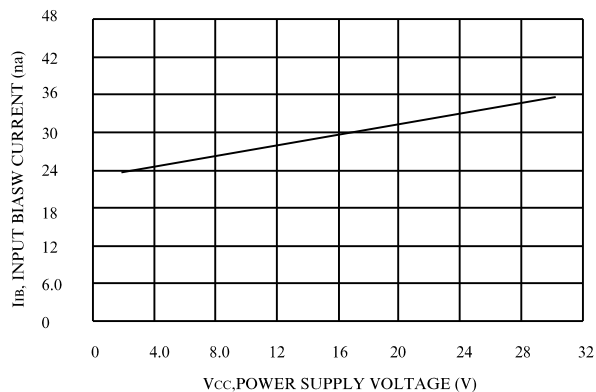

Figure 2. Input Bias Current

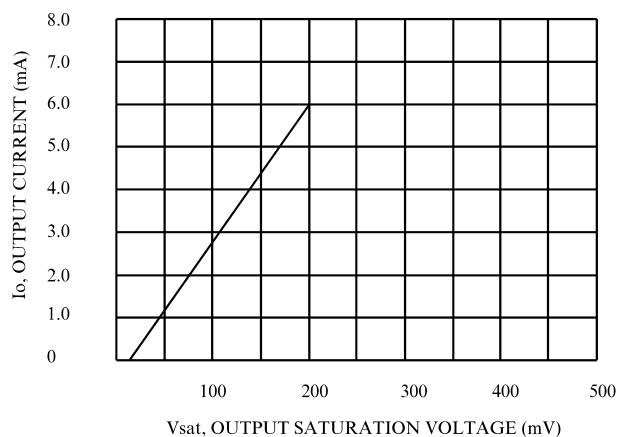

Figure 3. Output Sink Current versus Output Saturation Voltage

Important statement:

Huaguan Semiconductor Co,Ltd. reserves the right to change the products and services provided without notice. Customers should obtain the latest relevant information before ordering, and verify the timeliness and accuracy of this information.

Customers are responsible for complying with safety standards and taking safety measures when using our products for system design and machine manufacturing to avoid potential risks that may result in personal injury or property damage.

Our products are not licensed for applications in life support, military, aerospace, etc., so we do not bear the consequences of the application of these products in these fields.

Our documentation is only permitted to be copied without any tampering with the content, so we do not accept any responsibility or liability for the altered documents.

单击下面可查看定价，库存，交付和生命周期等信息

[>>HGSEMI\(华冠\)](#)