

## FEATURES

- Output current in excess of 1.5A
- Internal short current circuit limiting
- Internal thermal overload protection
- Output voltage offered of 4% tolerance

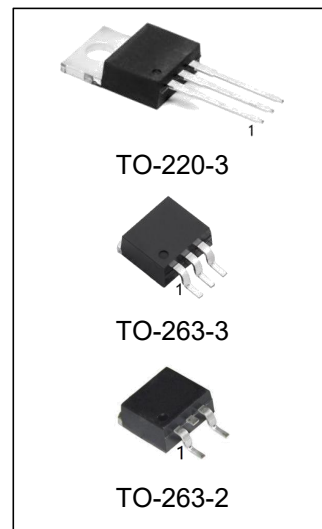

## ORDERING INFORMATION

DEVICE	Package Type	MARKING	Packing	Packing Qty
LM7905CT	TO-220-3	LM7905C	TUBE	1000pcs/box
LM7906CT	TO-220-3	LM7906C	TUBE	1000pcs/box
LM7908CT	TO-220-3	LM7908C	TUBE	1000pcs/box
LM7909CT	TO-220-3	LM7909C	TUBE	1000pcs/box
LM7912CT	TO-220-3	LM7912C	TUBE	1000pcs/box
LM7915CT	TO-220-3	LM7915C	TUBE	1000pcs/box
LM7918CT	TO-220-3	LM7918C	TUBE	1000pcs/box
LM7924CT	TO-220-3	LM7924C	TUBE	1000pcs/box
LM7905CS2/TR	TO-263-2	LM7905C	REEL	500 pcs/reel
LM7906CS2/TR	TO-263-2	LM7906C	REEL	500 pcs/reel
LM7908CS2/TR	TO-263-2	LM7908C	REEL	500 pcs/reel
LM7909CS2/TR	TO-263-2	LM7909C	REEL	500 pcs/reel
LM7912CS2/TR	TO-263-2	LM7912C	REEL	500 pcs/reel
LM7915CS2/TR	TO-263-2	LM7915C	REEL	500 pcs/reel
LM7918CS2/TR	TO-263-2	LM7918C	REEL	500 pcs/reel
LM7924CS2/TR	TO-263-2	LM7924C	REEL	500 pcs/reel
LM7905CS/TR	TO-263-3	LM7905C	REEL	500 pcs/reel
LM7906CS/TR	TO-263-3	LM7906C	REEL	500 pcs/reel
LM7908CS/TR	TO-263-3	LM7908C	REEL	500 pcs/reel
LM7909CS/TR	TO-263-3	LM7909C	REEL	500 pcs/reel
LM7912CS/TR	TO-263-3	LM7912C	REEL	500 pcs/reel
LM7915CS/TR	TO-263-3	LM7915C	REEL	500 pcs/reel
LM7918CS/TR	TO-263-3	LM7918C	REEL	500 pcs/reel
LM7924CS/TR	TO-263-3	LM7924C	REEL	500 pcs/reel

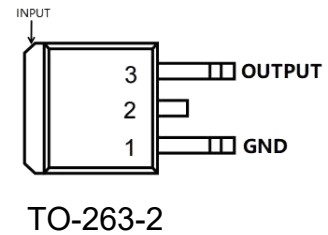
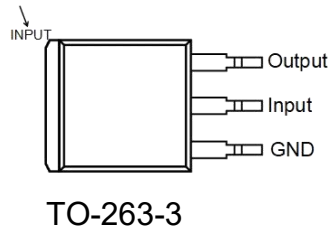
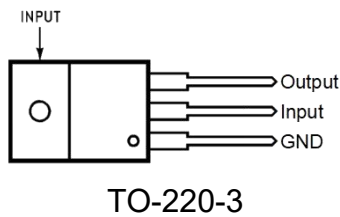
**PIN CONFIGURATION**

**ABSOLUTE MAXIMUM RATINGS**

Condition	VALUE	UNIT
Maximum input voltage at $T_J=25^\circ\text{C}$	-35	V
Maximum operating junction temperature	+125	$^\circ\text{C}$
Operating Temperature Range	0 ~ +125	$^\circ\text{C}$
Lead Temperature (TL) (Soldering, 10 seconds)	+245	$^\circ\text{C}$

**Note:** Absolute Maximum Ratings indicate limits beyond which damage to the device may occur. Operating Ratings indicate conditions for which the device is intended to be functional, but specific performance is not ensured.

**ELECTRICAL CHARACTERISTICS LM7905C**

( $V_{IN} = -10\text{V}$ ,  $I_O = 500\text{mA}$ ,  $C_{IN} = 2.2\mu\text{F}$ ,  $C_O = 1.0\mu\text{F}$ ,  $T_J = 25^\circ\text{C}$ , unless otherwise noted)

CHARACTERISTIC	SYMBOL	TEST CONDITION	NORMS		UNIT
			Min	Max	
Output Voltage	$V_O$	$-7.0\text{V} \geq V_{IN} \geq -20\text{V}$ $5.0\text{mA} \leq I_O \leq 1.0\text{A}$	-4.8	-5.2	V
Line Regulation	$\Delta U_V$	$I_O = 100\text{mA}$ , $-7.0\text{V} \geq V_{IN} \geq -25\text{V}$ $I_O = 100\text{mA}$ , $-8.0\text{V} \geq V_{IN} \geq -12\text{V}$ $I_O = 500\text{mA}$ , $-7.0\text{V} \geq V_{IN} \geq -25\text{V}$ $I_O = 500\text{mA}$ , $-8.0\text{V} \geq V_{IN} \geq -12\text{V}$		47.5 23.5 95 47.5	mV
Load Regulation	$\Delta U_I$	$5.0\text{mA} \leq I_O \leq 1.5\text{A}$ $250\text{mA} \leq I_O \leq 750\text{mA}$		95 47.5	mV
Quiescent Current	$I_B$			7.8	mA
Quiescent Current Change	$\Delta I_B$	$-7.0\text{V} \geq V_{IN} \geq -25\text{V}$ $5.0\text{mA} \leq I_O \leq 1.5\text{A}$		1.25 0.48	mA

**ELECTRICAL CHARACTERISTICS LM7906C**

 (V<sub>IN</sub> = -11V, I<sub>o</sub> = 500mA, C<sub>IN</sub> = 2.2μF, C<sub>o</sub> = 1.0μF, T<sub>J</sub> = 25°C, unless otherwise noted)

CHARACTERISTIC	SYMBOL	TEST CONDITION	NORMS		UNIT
			Min	Max	
Output Voltage	V <sub>o</sub>	-8.0V ≥ V <sub>IN</sub> ≥ -21V 5.0mA ≤ I <sub>o</sub> ≤ 1.0 A	-5.76	-6.24	V
Line Regulation	ΔU <sub>v</sub>	I <sub>o</sub> = 100mA, -8.0V ≥ V <sub>IN</sub> ≥ -25V I <sub>o</sub> = 100mA, -9.0V ≥ V <sub>IN</sub> ≥ -13V I <sub>o</sub> = 500mA, -8.0V ≥ V <sub>IN</sub> ≥ -25V I <sub>o</sub> = 500mA, -9.0V ≥ V <sub>IN</sub> ≥ -13V		57 28.5 114 57	mV
Load Regulation	ΔU <sub>I</sub>	5.0mA ≤ I <sub>o</sub> ≤ 1.5 A 250mA ≤ I <sub>o</sub> ≤ 750mA		114 57	mV
Quiescent Current	I <sub>B</sub>			7.8	mA
Quiescent Current Change	ΔI <sub>B</sub>	-8.0V ≥ V <sub>IN</sub> ≥ -25V 5.0mA ≤ I <sub>o</sub> ≤ 1.5 A		1.25 0.48	mA

**ELECTRICAL CHARACTERISTICS LM7908C**

 (V<sub>IN</sub> = -14V, I<sub>o</sub> = 500mA, C<sub>IN</sub> = 2.2μF, C<sub>o</sub> = 1.0μF, T<sub>J</sub> = 25°C, unless otherwise noted)

CHARACTERISTIC	SYMBOL	TEST CONDITION	NORMS		UNIT
			Min	Max	
Output Voltage	V <sub>o</sub>	-10.5V ≥ V <sub>IN</sub> ≥ -23V 5.0mA ≤ I <sub>o</sub> ≤ 1.0 A	-7.68	-8.32	V
Line Regulation	ΔU <sub>v</sub>	I <sub>o</sub> = 100mA, -10.5V ≥ V <sub>IN</sub> ≥ -25V I <sub>o</sub> = 100mA, -11V ≥ V <sub>IN</sub> ≥ -17V I <sub>o</sub> = 500mA, -10.5V ≥ V <sub>IN</sub> ≥ -25V I <sub>o</sub> = 500mA, -11V ≥ V <sub>IN</sub> ≥ -17V		76 38 152 76	mV
Load Regulation	ΔU <sub>I</sub>	5.0mA ≤ I <sub>o</sub> ≤ 1.5 A 250mA ≤ I <sub>o</sub> ≤ 750mA		152 76	mV
Quiescent Current	I <sub>B</sub>			7.8	mA
Quiescent Current Change	ΔI <sub>B</sub>	-10.5V ≥ V <sub>IN</sub> ≥ -25V 5.0mA ≤ I <sub>o</sub> ≤ 1.5 A		0.98 0.48	mA

**ELECTRICAL CHARACTERISTICS LM7909C**

(VIN = -16V, IO = 500mA, CIN = 2.2μF, CO = 1.0μF, TJ = 25°C, unless otherwise noted)

CHARACTERISTIC	SYMBOL	TEST CONDITION	NORMS		UNIT
			Min	Max	
Output Voltage	$V_O$	$-10.5V \geq V_{IN} \geq -25V$ $5.0mA \leq I_O \leq 1.0A$	-8.60	-9.40	V
Line Regulation	$\Delta U_V$	$I_O = 100mA, -11.8V \geq V_{IN} \geq -25V$ $I_O = 100mA, -12V \geq V_{IN} \geq -20V$ $I_O = 500mA, -11.8V \geq V_{IN} \geq -25V$ $I_O = 500mA, -12V \geq V_{IN} \geq -20V$		86 43 172 86	mV
Load Regulation	$\Delta U_I$	$5.0mA \leq I_O \leq 1.5A$ $250mA \leq I_O \leq 750mA$		171 86	mV
Quiescent Current	$I_B$			7.8	mA
Quiescent Current Change	$\Delta I_B$	$-10.5V \geq V_{IN} \geq -25V$ $5.0mA \leq I_O \leq 1.5A$		1.02 0.48	mA

**ELECTRICAL CHARACTERISTICS LM7912C**

(VIN = -19V, IO = 500mA, CIN = 2.2μF, CO = 1.0μF, TJ = 25°C, unless otherwise noted)

CHARACTERISTIC	SYMBOL	TEST CONDITION	NORMS		UNIT
			Min	Max	
Output Voltage	$V_O$	$-14.5V \geq V_{IN} \geq -21V$ $5.0mA \leq I_O \leq 1.0A$	-11.52	-12.48	V
Line Regulation	$\Delta U_V$	$I_O = 100mA, -14.5V \geq V_{IN} \geq -30V$ $I_O = 100mA, -16V \geq V_{IN} \geq -22V$ $I_O = 500mA, -14.5V \geq V_{IN} \geq -30V$ $I_O = 500mA, -16V \geq V_{IN} \geq -22V$		114 58.5 228 114	mV
Load Regulation	$\Delta U_I$	$5.0mA \leq I_O \leq 1.5A$ $250mA \leq I_O \leq 750mA$		228 114	mV
Quiescent Current	$I_B$			7.8	mA
Quiescent Current Change	$\Delta I_B$	$-14.5V \geq V_{IN} \geq -30V$ $5.0mA \leq I_O \leq 1.5A$		1.25 0.48	mA

**ELECTRICAL CHARACTERISTICS LM7915C**

 ( $V_{IN} = -23V$ ,  $I_o = 500mA$ ,  $C_{IN} = 2.2\mu F$ ,  $C_o = 1.0\mu F$ ,  $T_J = 25^\circ C$ , unless otherwise noted)

CHARACTERISTIC	SYMBOL	TEST CONDITION	NORMS		UNIT
			Min	Max	
Output Voltage	$V_o$	$-17.5V \geq V_{IN} \geq -30V$ $5.0mA \geq I_o \geq 1.0 A$	-14.4	-15.6	V
Line Regulation	$\Delta U_v$	$I_o = 100mA$ , $-17.5V \geq V_{IN} \geq -30V$ $I_o = 100mA$ , $-20V \geq V_{IN} \geq -26V$ $I_o = 500mA$ , $-17.5V \geq V_{IN} \geq -30V$ $I_o = 500mA$ , $-20V \geq V_{IN} \geq -26V$		142 71 285 142	mV
Load Regulation	$\Delta U_l$	$5.0mA \leq I_o \leq 1.5 A$ $250mA \leq I_o \leq 750mA$		285 142	mV
Quiescent Current	$I_B$			7.8	mA
Quiescent Current Change	$\Delta I_B$	$-17.5V \geq V_{IN} \geq -30V$ $5.0mA \leq I_o \leq 1.5 A$		0.98 0.48	mA

**ELECTRICAL CHARACTERISTICS LM7918C**

 ( $V_{IN} = -27V$ ,  $I_o = 500mA$ ,  $C_{IN} = 2.2\mu F$ ,  $C_o = 1.0\mu F$ ,  $T_J = 25^\circ C$ , unless otherwise noted)

CHARACTERISTIC	SYMBOL	TEST CONDITION	NORMS		UNIT
			Min	Max	
Output Voltage	$V_o$	$-21V \geq V_{IN} \geq -33V$ $5.0mA \leq I_o \leq 1.0 A$	-17.28	-18.72	V
Line Regulation	$\Delta U_v$	$I_o = 100mA$ , $-21V \geq V_{IN} \geq -33V$ $I_o = 100mA$ , $-24V \geq V_{IN} \geq -30V$ $I_o = 500mA$ , $-21V \geq V_{IN} \geq -33V$ $I_o = 500mA$ , $-24V \geq V_{IN} \geq -30V$		171 85.5 342 171	mV
Load Regulation	$\Delta U_l$	$5.0mA \leq I_o \leq 1.5 A$ $250mA \leq I_o \leq 750mA$		342 171	mV
Quiescent Current	$I_B$			7.8	mA
Quiescent Current Change	$\Delta I_B$	$-21V \geq V_{IN} \geq -33V$ $5.0mA \leq I_o \leq 1.5 A$		0.98 0.48	mA

**ELECTRICAL CHARACTERISTICS LM7924C**

 ( $V_{IN} = -33V$ ,  $I_o = 500mA$ ,  $C_{IN} = 2.2\mu F$ ,  $C_o = 1.0\mu F$ ,  $T_J = 25^\circ C$ , unless otherwise noted)

CHARACTERISTIC	SYMBOL	TEST CONDITION	NORMS		UNIT
			Min	Max	
Output Voltage	$V_o$	$-27V \geq V_{IN} \geq -38V$ $5.0mA \leq I_o \leq 1.0 A$	-23	-25	V
Line Regulation	$\Delta U_v$	$I_o = 100mA$ , $-27V \geq V_{IN} \geq -38V$ $I_o = 100mA$ , $-30V \geq V_{IN} \geq -36V$ $I_o = 500mA$ , $-27V \geq V_{IN} \geq -38V$ $I_o = 500mA$ , $-30V \geq V_{IN} \geq -36V$		228 114 446 228	mV
Load Regulation	$\Delta U_l$	$5.0mA \leq I_o \leq 1.5 A$ $250mA \leq I_o \leq 750mA$		446 228	mV
Quiescent Current	$I_B$			7.8	mA
Quiescent Current Change	$\Delta I_B$	$-27V \geq V_{IN} \geq -33V$ $5.0mA \leq I_o \leq 1.5 A$		0.98 0.48	mA

**PHYSICAL DIMENSIONS**

TO-263-3

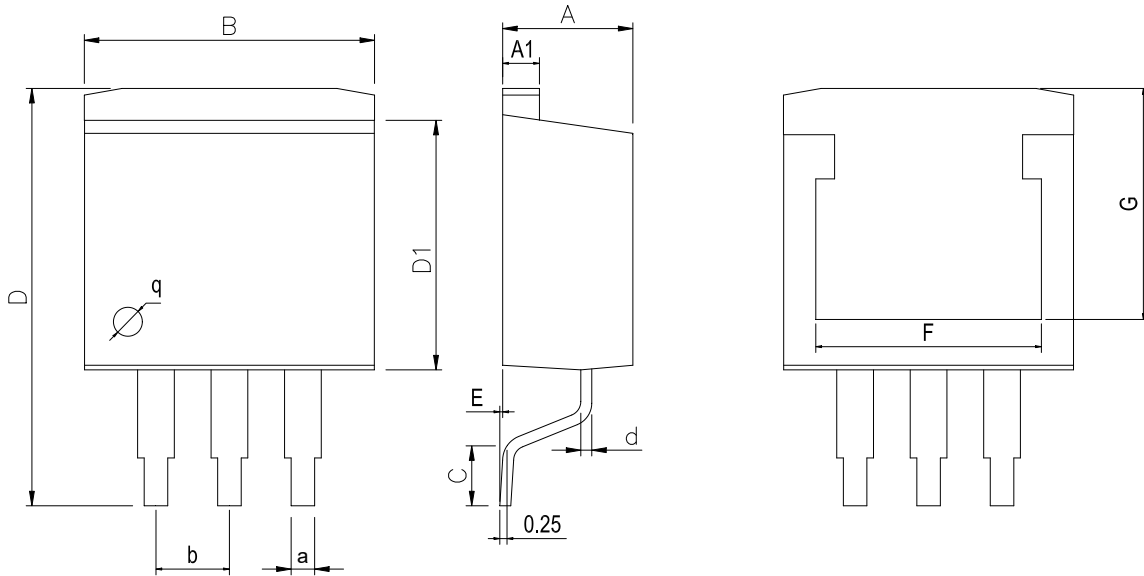

Dimensions In Millimeters(TO-263-3)											
Symbol:	A	A1	B	C	D	D1	E	F	G	a	b
Min:	4.45	1.22	10	1.89	13.7	8.38	0	8.332	7.70	0.71	2.54BSC
Max:	4.62	1.32	10.4	2.19	14.6	8.89	0.305	8.552	8.10	0.97	

TO-220-3

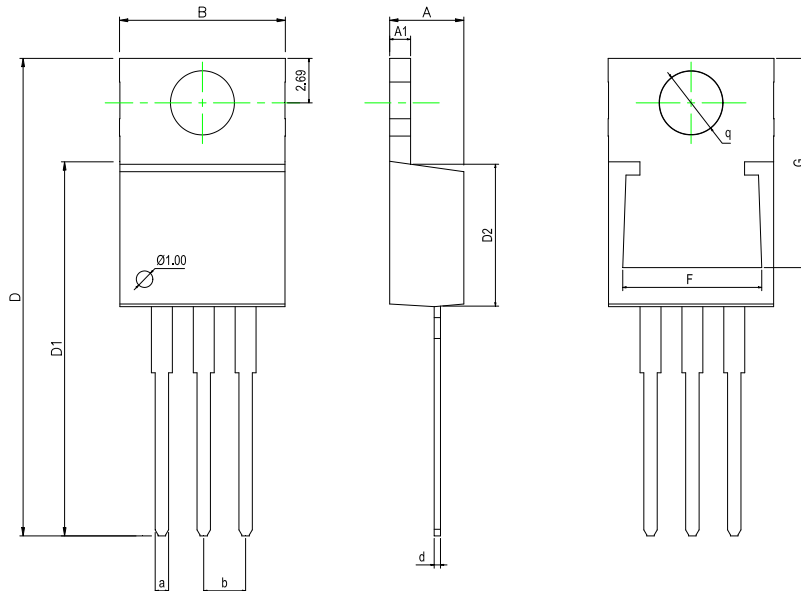

Dimensions In Millimeters(TO-220-3)												
Symbol:	A	A1	B	D	D1	D2	F	G	a	d	b	q
Min:	4.45	1.22	10	28.2	22.22	8.50	8.30	12.55	0.71	0.33	2.54BS	3.80TYP
Max:	4.62	1.32	10.4	28.9	22.62	9.10	8.55	12.75	0.97	0.42	C	

**PHYSICAL DIMENSIONS**

TO-263-2

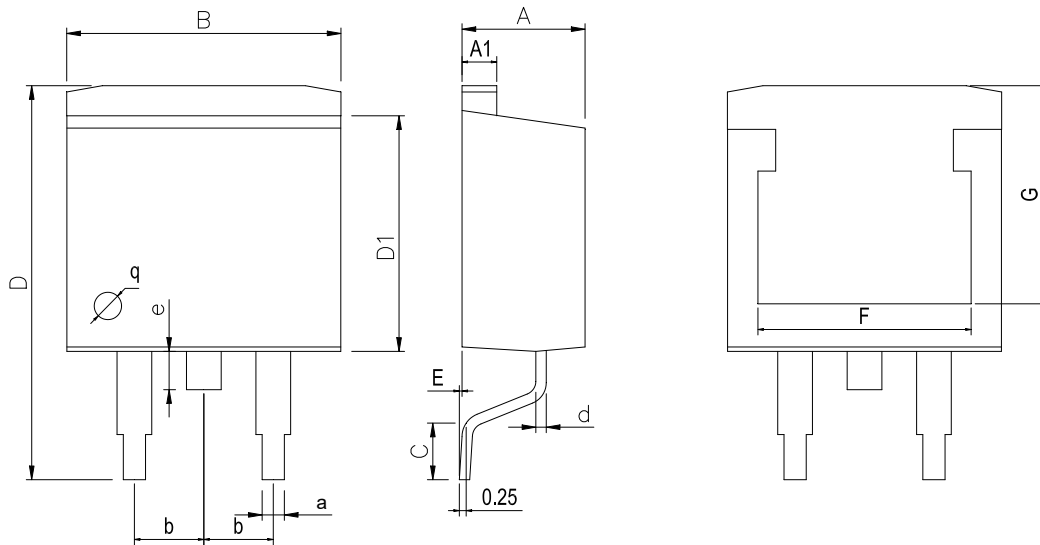

Dimensions In Millimeters(TO-263-2)												
Symbol:	A	A1	B	C	D	D1	E	F	G	a	e	b
Min:	4.45	1.22	10	2.25	14.5	8.45	0	8.30	7.70	0.71	1.10	2.54BSC
Max:	4.62	1.32	10.4	2.85	15.4	9.10	0.305	8.55	8.10	0.97	1.70	



**REVISION HISTORY**

DATE	REVISION	PAGE
2018-1-5	New	1-10
2023-9-13	Update Lead Temperature、 Update Package Type、 Add annotation for Maximum Ratings.	1、 2

**IMPORTANT STATEMENT:**

Huaguan Semiconductor reserves the right to change its products and services without notice. Before ordering, the customer shall obtain the latest relevant information and verify whether the information is up to date and complete. Huaguan Semiconductor does not assume any responsibility or obligation for the altered documents.

Customers are responsible for complying with safety standards and taking safety measures when using Huaguan Semiconductor products for system design and machine manufacturing. You will bear all the following responsibilities: Select the appropriate Huaguan Semiconductor products for your application; Design, validate and test your application; Ensure that your application meets the appropriate standards and any other safety, security or other requirements. To avoid the occurrence of potential risks that may lead to personal injury or property loss.

Huaguan Semiconductor products have not been approved for applications in life support, military, aerospace and other fields, and Huaguan Semiconductor will not bear the consequences caused by the application of products in these fields. All problems, responsibilities and losses arising from the user's use beyond the applicable area of the product shall be borne by the user and have nothing to do with Huaguan Semiconductor, and the user shall not claim any compensation liability against Huaguan Semiconductor by the terms of this Agreement.

The technical and reliability data (including data sheets), design resources (including reference designs), application or other design suggestions, network tools, safety information and other resources provided for the performance of semiconductor products produced by Huaguan Semiconductor are not guaranteed to be free from defects and no warranty, express or implied, is made. The use of testing and other quality control technologies is limited to the quality assurance scope of Huaguan Semiconductor. Not all parameters of each device need to be tested.

The documentation of Huaguan Semiconductor authorizes you to use these resources only for developing the application of the product described in this document. You have no right to use any other Huaguan Semiconductor intellectual property rights or any third party intellectual property rights. It is strictly forbidden to make other copies or displays of these resources. You should fully compensate Huaguan Semiconductor and its agents for any claims, damages, costs, losses and debts caused by the use of these resources. Huaguan Semiconductor accepts no liability for any loss or damage caused by infringement.

单击下面可查看定价，库存，交付和生命周期等信息

[>>HGSEMI\(华冠\)](#)