

11MHZ CMOS Rail-to-Rail IO Opamps

Features

- Single-Supply Operation from +2.1V ~ +5.5V
- Rail-to-Rail Input / Output
- Gain-Bandwidth Product: 11MHz (Typ.)
- Low Input Bias Current: 1pA (Typ.)
- Low Offset Voltage: 3.5mV (Max.)
- High Slew Rate: 9V/μs
- Settling Time to 0.1% with 2V Step: 0.3μs
- Low Noise : 8nV/ Hz @10kHz
- Quiescent Current: 1.1mA per Amplifier (Typ.)
- Operating Temperature: -40°C ~ +85°C
- Small Package:
 - HGV6021 Available in SOT23-5,MSOP-8 and SC70-5 Packages
 - HGV6022 Available in SOP-8 and MSOP-8 Packages
 - HGV6024 Available in SOP-14 and TSSOP-14 Packages



Package/Ordering Information

DEVICE	Package Type	MARKING	Packing	Packing Qty
HGV6021M5/TR	SOT-23-5	6021	REEL	3000pcs/reel
HGV6021M7/TR	SC70-5(SOT-353)	6021	REEL	3000pcs/reel
HGV6021M/TR	SOP-8	V6021	REEL	2500pcs/reel
HGV6021MM/TR	MSOP-8	V6021	REEL	3000pcs/reel
HGV6022M/TR	SOP-8	V6022	REEL	2500pcs/reel
HGV6022MM/TR	MSOP-8	V6022	REEL	3000pcs/reel
HGV6024M/TR	SOP-14	HGV6024	REEL	2500pcs/reel
HGV6024MT/TR	TSSOP-14	V6024	REEL	2500pcs/reel

General Description

The HGV602X have a high gain-bandwidth product of 11MHz, a slew rate of 9V μ /s, and a quiescent current of 1.1mA per amplifier at 5V. The HGV602X are designed to provide optimal performance in low voltage and low noise systems. They provide rail-to-rail output swing into heavy loads. The input common mode voltage range includes ground, and the maximum input offset voltage is 3.5mV for HGV602X. They are specified over the extended industrial temperature range (-40 °C to +85 °C). The operating range is from 2.1V to 5.5V. The HGV6021 single is available in Green SC70-5, SOT-23-5, MSOP-8 and SOP-8 packages. The HGV6022 dual is available in Green SOP-8 and MSOP-8 packages. The HGV6024 Quad is available in Green SOP-14 and TSSOP-14 packages.

Applications

- Sensors
- Active Filters
- Cellular and Cordless Phones
- Laptops and PDAs
- Audio
- Handheld Test Equipment
- Battery-Powered Instrumentation
- A/D Converters

Pin Configuration

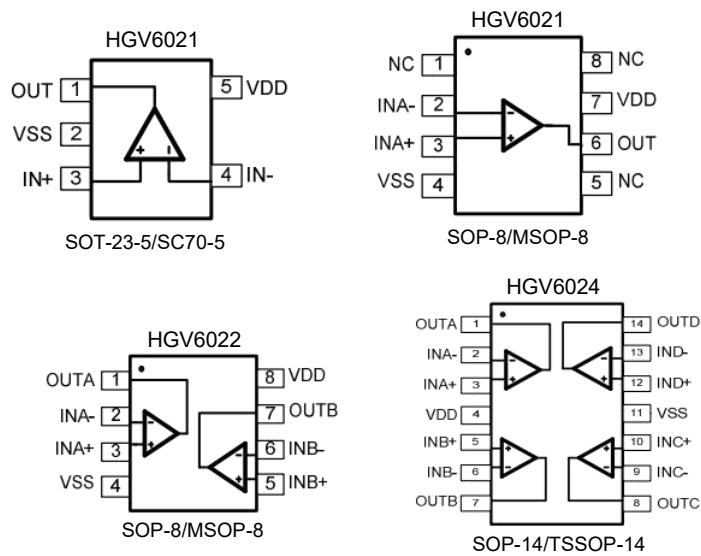

Figure 1. Pin Assignment Diagram

Absolute Maximum Ratings

Condition	Min	Max
Power Supply Voltage (VDD to Vss)	-0.5V	+7.5V
Analog Input Voltage (IN+ or IN-)	Vss-0.5V	VDD+0.5V
PDB Input Voltage	Vss-0.5V	+7V
Operating Temperature Range	-40°C	+85°C
Junction Temperature	+160°C	
Storage Temperature Range	-55°C	+150°C
Lead Temperature (soldering, 10sec)	+245°C	
Package Thermal Resistance (TA=+25°C)		
SOP-8, θ_{JA}	125°C/W	
MSOP-8, θ_{JA}	216°C/W	
SOT-23-5, θ_{JA}	190°C/W	
SOT23-6, θ_{JA}	190°C/W	
SC70-5, θ_{JA}	333°C/W	
ESD Susceptibility		
HBM	8KV	
MM	400V	

Note:

Stress greater than those listed under Absolute Maximum Ratings may cause permanent damage to the device. This is a stress rating only and functional operation of the device at these or any other conditions outside those indicated in the operational sections of this specification are not implied. Exposure to absolute maximum rating conditions for extended periods may affect reliability.

Electrical Characteristics

 (At $V_S=5V$, $T_A = +25^\circ C$, $V_{CM} = V_S/2$, $R_L = 600\Omega$, unless otherwise noted.)

PARAMETER	CONDITIONS	HGV6021/2/4						
		TYP	MIN/MAX OVER TEMPERATURE				UNITS	MIN / MAX
		+25 $^\circ C$	+25 $^\circ C$	0 $^\circ C$ to 70 $^\circ C$	-40 $^\circ C$ to 85 $^\circ C$			
INPUT CHARACTERISTICS								
Input Offset Voltage (VOS)		0.8	3.5	3.9	4.3	mV	MAX	
Input Bias Current (IB)		1				pA	TYP	
Input Offset Current (IOS)		1				pA	TYP	
Input Common Mode Voltage Range (VCM)	$V_S = 5.5V$	-0.1 to +5.6				V	TYP	
Common Mode Rejection Ratio (CMRR)	$V_S = 5.5V, V_{CM} = -0.1V$ to 4V	82	65	64	64	dB	MIN	
	$V_S = 5.5V, V_{CM} = -0.1V$ to 5.6V	75				dB	MIN	
Open-Loop Voltage Gain (AOL)	$R_L = 600\Omega, V_O = 0.15V$ to 4.85V	90	80	76	75	dB	MIN	
	$R_L = 10k\Omega, V_O = 0.05V$ to 4.95V	108				dB	MIN	
Input Offset Voltage Drift ($\Delta V_{OS}/T$)		2.4				$\mu V/^\circ C$	TYP	
OUTPUT CHARACTERISTICS								
Output Voltage Swing from Rail	$R_L = 600\Omega$	0.1				V	TYP	
	$R_L = 10k\Omega$	0.015				V	TYP	
Output Current (IOUT)		70	55	45	42	mA	MIN	
Closed-Loop Output Impedance	$f = 100kHz, G = 1$	7.5				Ω	TYP	
POWER-DOWN DISABLE								
Turn-On Time		1.1				μs	TYP	
Turn-Off Time		0.3				μs	TYP	
DISABLE Voltage-Off			0.8			μsV	MAX	
DISABLE Voltage-On			2			V	MAX	
POWER SUPPLY								
Operating Voltage Range			2.1	2.1	2.1	V	MIN	
			5.5	5.5	5.5	V	MAX	
Power Supply Rejection Ratio (PSRR)	$V_S = +2.5V$ to 5.5V	91	74	72	72	dB	MIN	
	$V_{CM} = (-V_S) + 0.5$	1.1	1.5	1.65	1.7	mA	MAX	
Quiescent Current/Amplifier (IQ)	$V_{IOUT} = 0$							

Electrical Characteristics

 (At $V_s=5V$, $T_A = +25^\circ C$, $V_{CM} = V_S/2$, $R_L = 600\Omega$, unless otherwise noted.)

PARAMETER	CONDITIONS	HGV6021/2/4						
		TYP	MIN/MAX OVER TEMPERATURE				UNITS	MIN / MAX
		+25 $^\circ C$	+25 $^\circ C$	0 $^\circ C$ to 70 $^\circ C$	-40 $^\circ C$ to 85 $^\circ C$			
DYNAMIC PERFORMANCE								
Gain-Bandwidth Product (GBP)	$R_L = 10k\Omega$, $C_L = 100pF$	11					MHz	TYP
Phase Margin (ϕ_O)	$R_L = 10k\Omega$, $C_L = 100pF$	51					Degrees	TYP
Full Power Bandwidth (BWP)	< 1% distortion, $R_L = 600\Omega$	400					kHz	TYP
Slew Rate (SR)	$G = +1$, 2V Step, $R_L = 10k\Omega$	9					V/ μs	TYP
Settling Time to 0.1% (t_S)	$G = +1$, 2V Step, $R_L = 600\Omega$	0.3					μs	TYP
Overload Recovery Time	$V_{IN} \cdot Gain = V_S$, $R_L = 600\Omega$	1.5					μs	TYP
NOISE PERFORMANCE								
Voltage Noise Density (e_n)	$f = 1kHz$	11.5					nV/\sqrt{Hz}	TYP
	$f = 10kHz$	8					nV/\sqrt{Hz}	TYP

Typical Performance characteristics

(At $V_s=5V$, $T_A = +25^\circ C$, $V_{CM} = V_S/2$, $R_L = 600\Omega$, unless otherwise noted.)

Small-Signal Step Response

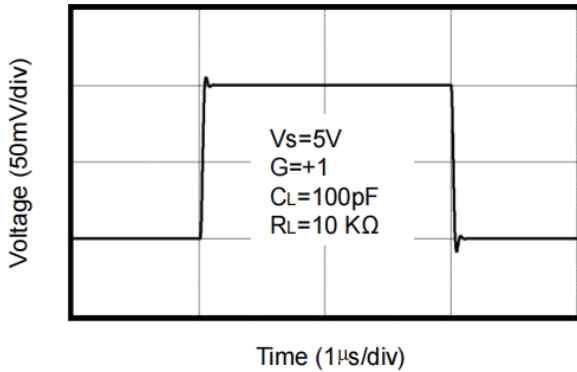

Small-Signal Step Response

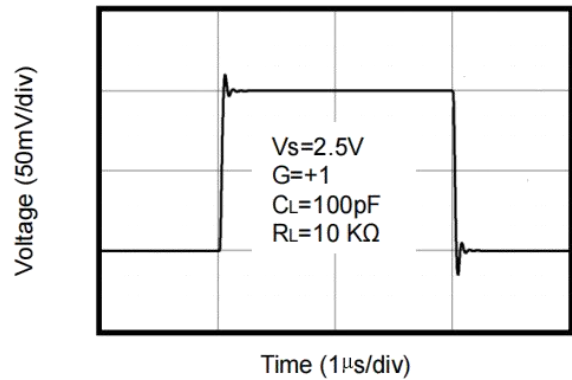

Large-Signal Step Response

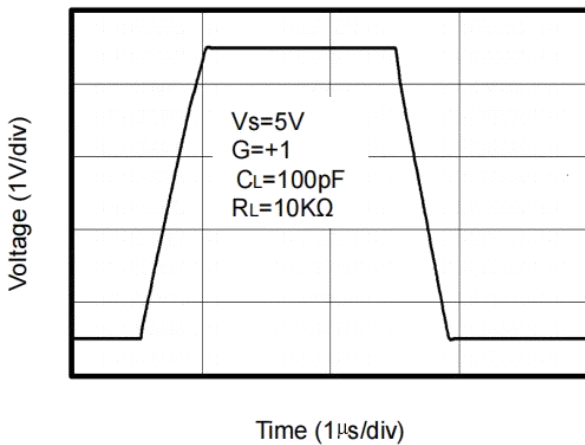

Large-Signal Step Response

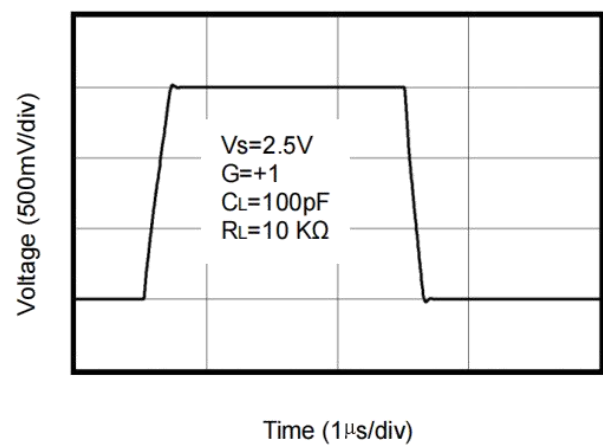

Positive Overload Recovery

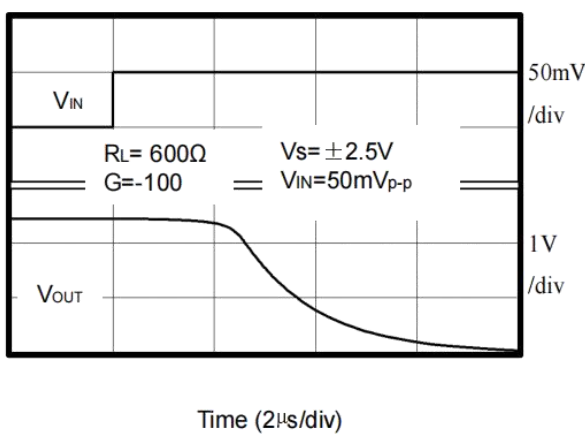

Negative Overload Recovery

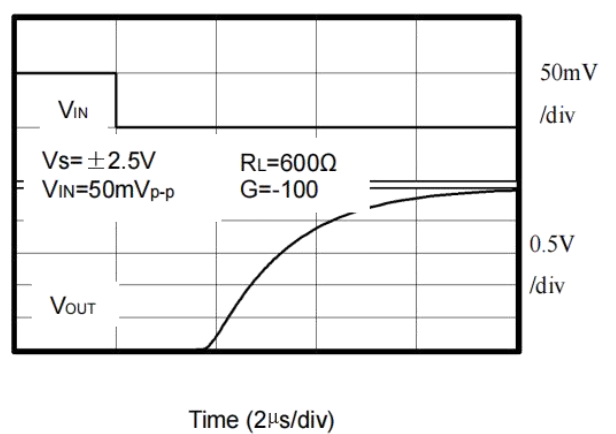

Typical Performance characteristics

(At $V_s=5V$, $T_A = +25^\circ C$, $V_{CM} = V_S/2$, $R_L = 600\Omega$, unless otherwise noted.)

Output Voltage Swing vs. Output Current

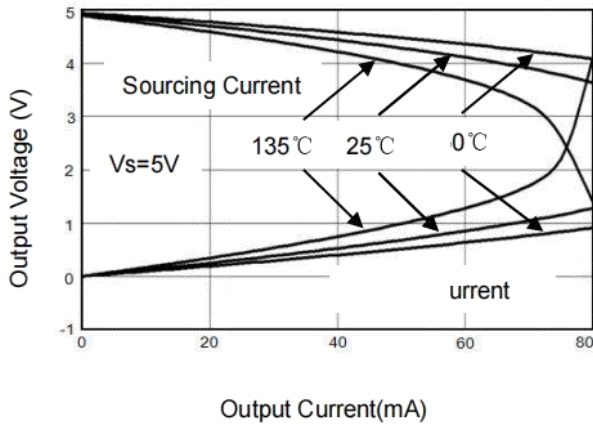

Supply Current vs. Temperature

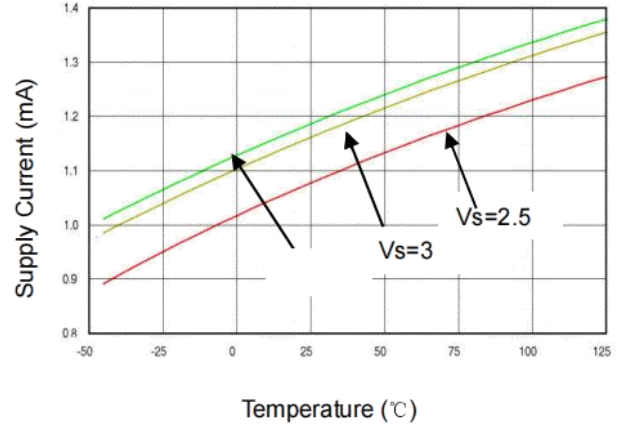

Input Voltage Noise Spectral Density vs. Frequency

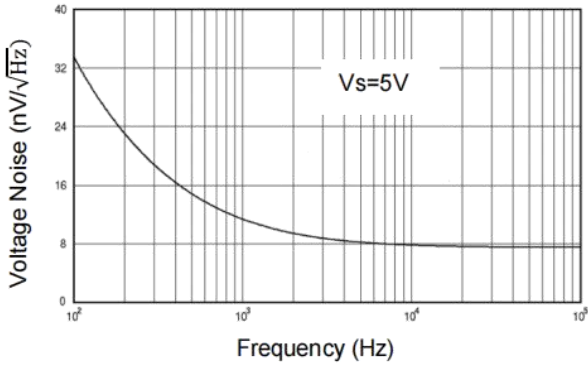

Open Loop Gain, Phase Shift vs. Frequency

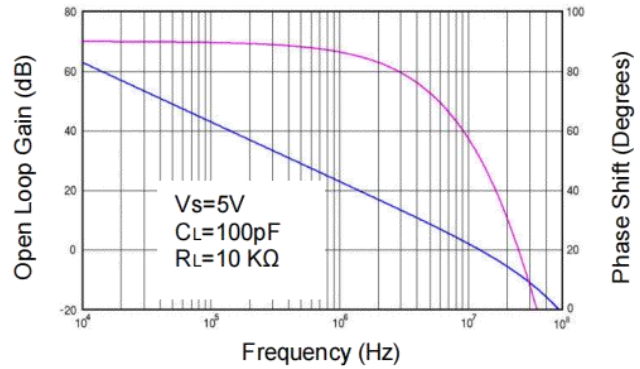

CMRR vs. Frequency

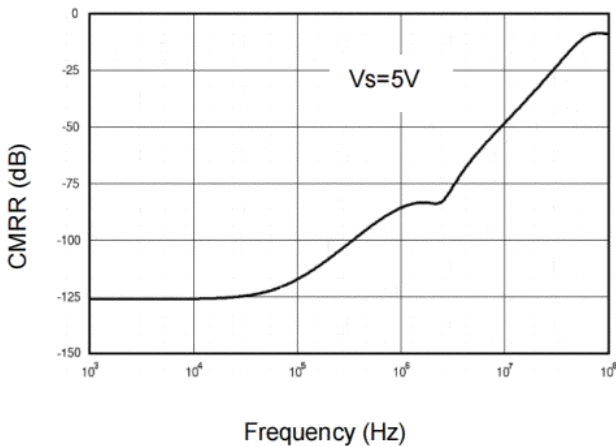

PSRR vs. Frequency

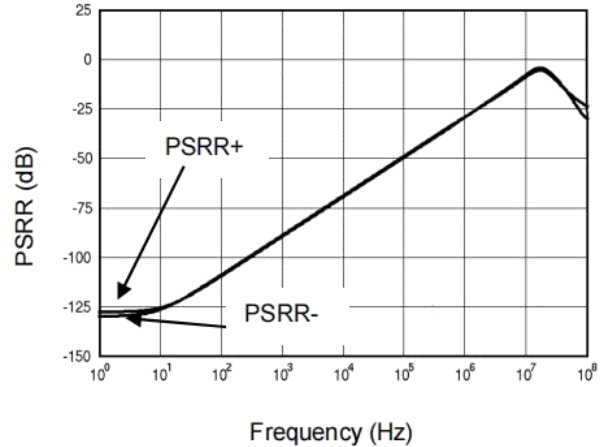

Application Note

Size

HGV602X series op amps are unity-gain stable and suitable for a wide range of general-purpose applications. The small footprints of the HGV602X series packages save space on printed circuit boards and enable the design of smaller electronic products.

Power Supply Bypassing and Board Layout

HGV602X series operates from a single 2.1V to 5.5V supply or dual $\pm 1.05V$ to $\pm 2.75V$ supplies. For best performance, a 0.1 μ F ceramic capacitor should be placed close to the VDD pin in single supply operation. For dual supply operation, both VDD and VSS supplies should be bypassed to ground with separate 0.1 μ F ceramic capacitors.

Low Supply Current

The low supply current (typical 1.1mA per channel) of HGV602X series will help to maximize battery life. They are ideal for battery powered systems.

Operating Voltage

HGV602X series operate under wide input supply voltage (2.1V to 5.5V). In addition, all temperature specifications apply from -40 °C to +85 °C. Most behavior remains unchanged throughout the full operating voltage range. These guarantees ensure operation throughout the single Li-Ion battery lifetime.

Rail-to-Rail Input

The input common-mode range of HGV602X series extends 100mV beyond the supply rails (VSS-0.1V to VDD+0.1V). This is achieved by using complementary input stage. For normal operation, inputs should be limited to this range.

Rail-to-Rail Output

Rail-to-Rail output swing provides maximum possible dynamic range at the output. This is particularly important when operating in low supply voltages. The output voltage of HGV602X series can typically swing to less than 2mV from supply rail in light resistive loads (>100k Ω), and 15mV of supply rail in moderate resistive loads (10k Ω).

Capacitive Load Tolerance

The HGV602X family is optimized for bandwidth and speed, not for driving capacitive loads. Output capacitance will create a pole in the amplifier's feedback path, leading to excessive peaking and potential oscillation. If dealing with load capacitance is a requirement of the application, the two strategies to consider are (1) using a small resistor in series with the amplifier's output and the load capacitance and (2) reducing the bandwidth of the amplifier's feedback loop by increasing the overall noise gain. Figure 2. shows a unity gain follower using the series resistor strategy. The resistor isolates the output from the capacitance and, more importantly, creates a zero in the feedback path that compensates for the pole created by the output capacitance.

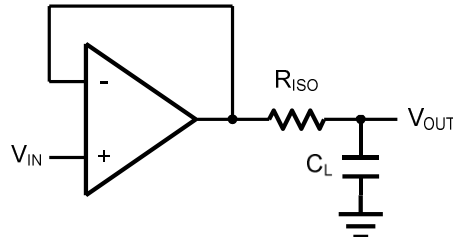

Figure 2. Indirectly Driving a Capacitive Load Using Isolation Resistor

The bigger the RISO resistor value, the more stable VOUT will be. However, if there is a resistive load RL in parallel with the capacitive load, a voltage divider (proportional to RISO/RL) is formed, this will result in a gain error.

The circuit in Figure 3 is an improvement to the one in Figure 2. RF provides the DC accuracy by feed-forward the VIN to RL. CF and RISO serve to counteract the loss of phase margin by feeding the high frequency component of the output signal back to the amplifier's inverting input, thereby preserving the phase margin in the overall feedback loop. Capacitive drive can be increased by increasing the value of CF. This in turn will slow down the pulse response.

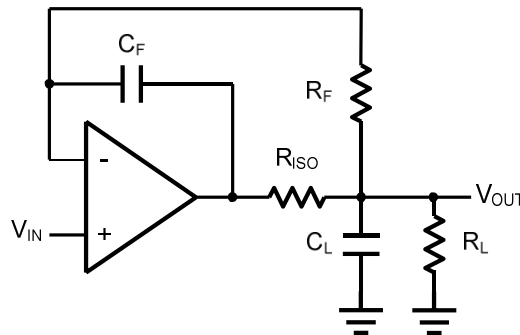

Figure 3. Indirectly Driving a Capacitive Load with DC Accuracy

Typical Application Circuits

Differential amplifier

The differential amplifier allows the subtraction of two input voltages or cancellation of a signal common to the two inputs. It is useful as a computational amplifier in making a differential to single-end conversion or in rejecting a common mode signal.

Figure 4. shown the differential amplifier using HGV602X.

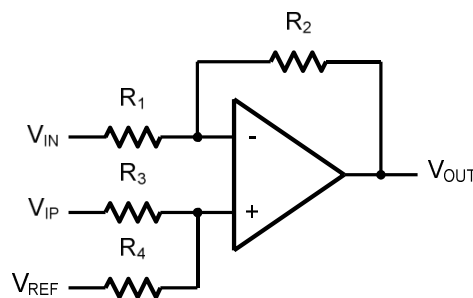

Figure 4. Differential Amplifier

$$V_{OUT} = \left(\frac{R_2+R_3}{R_3+R_4}\right) \frac{R_4}{R_1} V_{IN} - \frac{R_2}{R_1} V_{IP} + \left(\frac{R_2+R_3}{R_3+R_4}\right) \frac{R_3}{R_1} V_{REF}$$

If the resistor ratios are equal (i.e. $R_1=R_3$ and $R_2=R_4$), then

$$V_{OUT} = \frac{R_2}{R_1} (V_{IP} - V_{IN}) + V_{REF}$$

Low Pass Active Filter

The low pass active filter is shown in Figure 5. The DC gain is defined by $-R_2/R_1$. The filter has a -20dB/decade roll-off after its corner frequency $f_c=1/(2\pi R_3C_1)$.

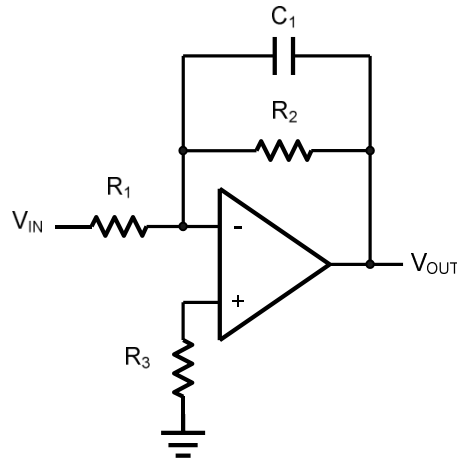

Instrumentation Amplifier

The triple HGV602X can be used to build a three-op-amp instrumentation amplifier as shown in Figure 6. The amplifier in Figure 6 is a high input impedance differential amplifier with gain of R_2/R_1 . The two differential voltage followers assure the high input impedance of the amplifier.

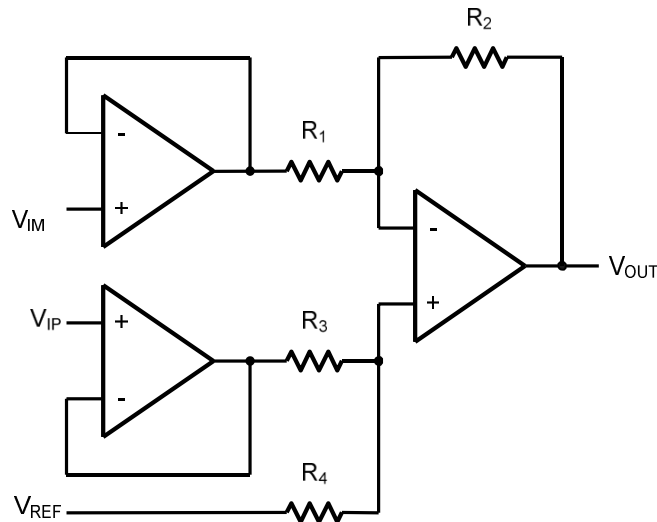
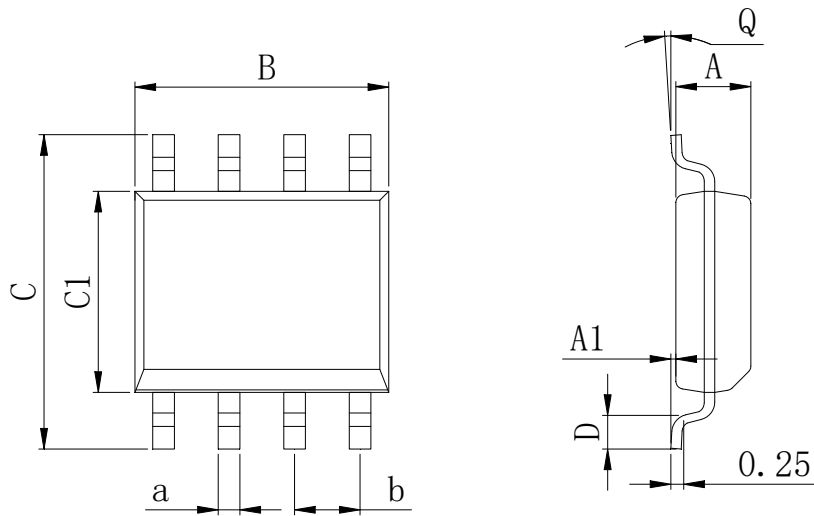

Figure 6. Instrument Amplifier

Physical Dimensions

SOP-8



Dimensions In Millimeters(SOP-8)

Symbol:	A	A1	B	C	C1	D	Q	a	b
Min:	1.35	0.05	4.90	5.80	3.80	0.40	0°	0.35	1.27 BSC
Max:	1.55	0.20	5.10	6.20	4.00	0.80	8°	0.45	

MSOP-8

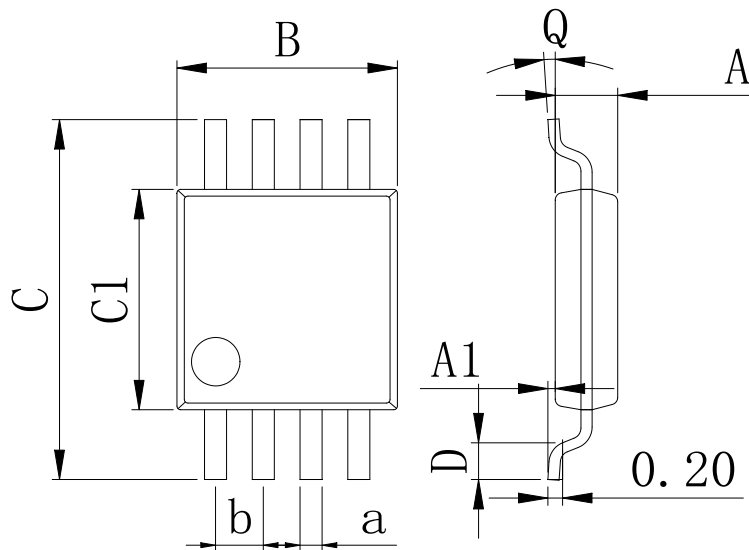

Dimensions In Millimeters(MSOP-8)

Symbol:	A	A1	B	C	C1	D	Q	a	b
Min:	0.80	0.05	2.90	4.75	2.90	0.35	0°	0.25	0.65 BSC
Max:	0.90	0.20	3.10	5.05	3.10	0.75	8°	0.35	

Physical Dimensions

SOP-14

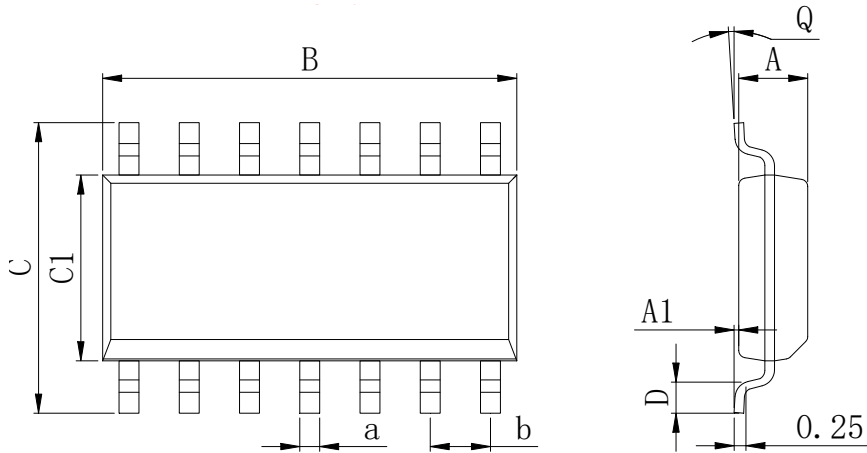

Dimensions In Millimeters(SOP-14)									
Symbol:	A	A1	B	C	C1	D	Q	a	b
Min:	1.35	0.05	8.55	5.80	3.80	0.40	0°	0.35	1.27 BSC
Max:	1.55	0.20	8.75	6.20	4.00	0.80	8°	0.45	

TSSOP-14

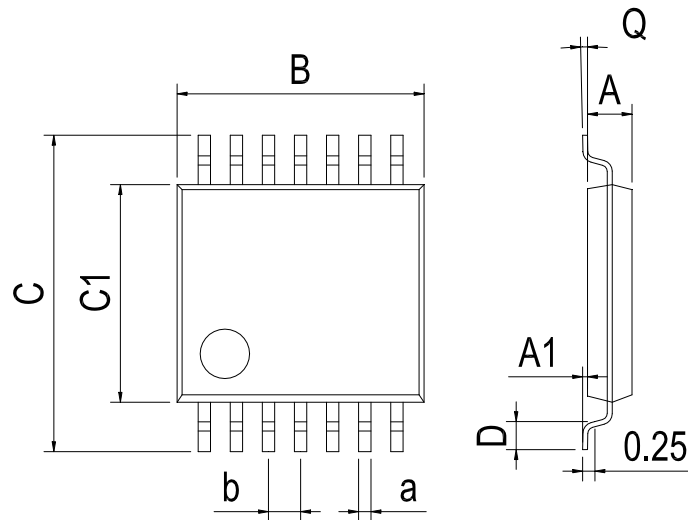

Dimensions In Millimeters(TSSOP-14)									
Symbol:	A	A1	B	C	C1	D	Q	a	b
Min:	0.85	0.05	4.90	6.20	4.30	0.40	0°	0.20	0.65 BSC
Max:	0.95	0.20	5.10	6.60	4.50	0.80	8°	0.25	

Physical Dimensions

SOT-23-5

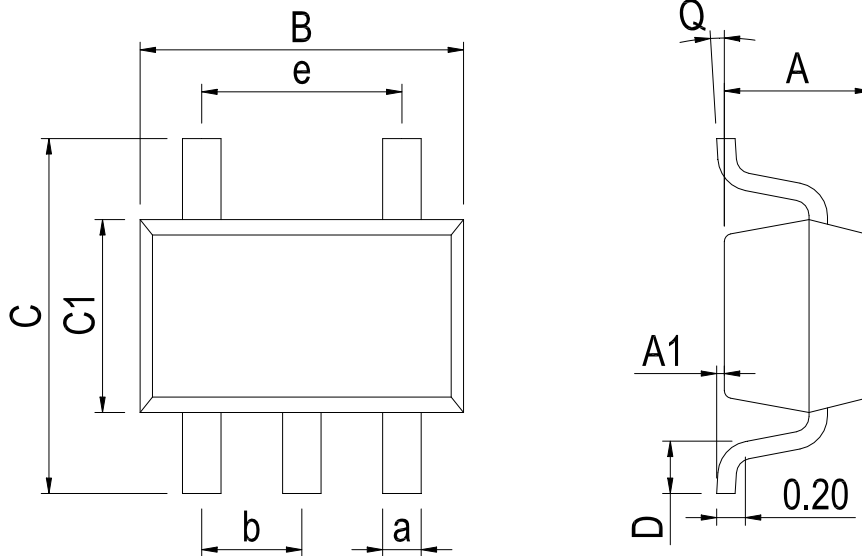

Dimensions In Millimeters(SOT-23-5)

Symbol:	A	A1	B	C	C1	D	Q	a	b	e
Min:	1.05	0.00	2.82	2.65	1.50	0.30	0°	0.30	0.95 BSC	1.90 BSC
Max:	1.15	0.15	3.02	2.95	1.70	0.60	8°	0.40		

SC70-5

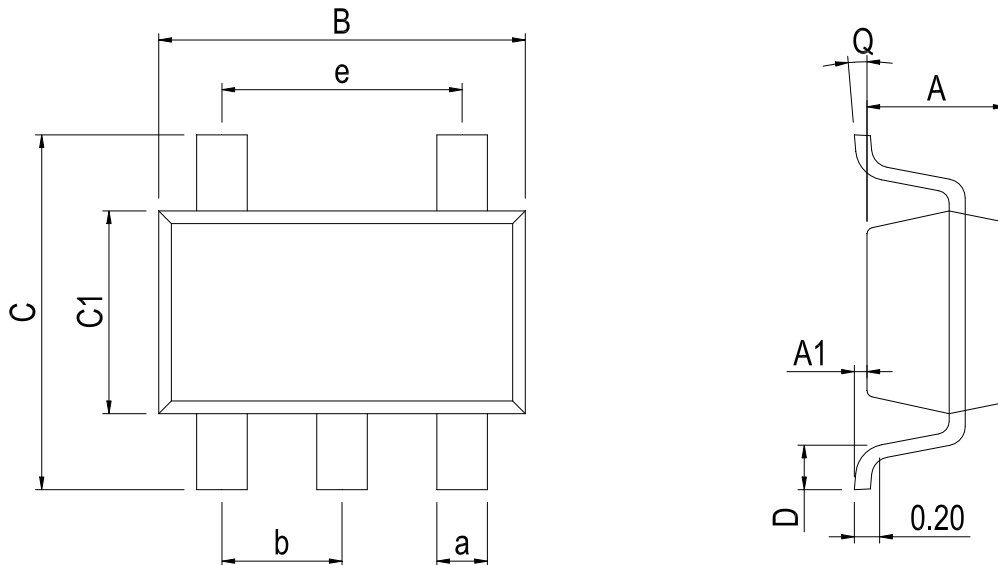

Dimensions In Millimeters(SC70-5)

Symbol:	A	A1	B	C	C1	D	Q	a	b	e
Min:	0.90	0.00	2.00	2.15	1.15	0.26	0°	0.15	0.65	1.30 BSC
Max:	1.00	0.15	2.20	2.45	1.35	0.46	8°	0.35	BSC	

Revision History

DATE	REVISION	PAGE
2015-3-8	New	1-15
2023-10-30	Update encapsulation type, Update Lead Temperature、Update SC70-5 Physical Dimensions	1, 3、13

IMPORTANT STATEMENT:

Huaguan Semiconductor reserves the right to change its products and services without notice. Before ordering, the customer shall obtain the latest relevant information and verify whether the information is up to date and complete. Huaguan Semiconductor does not assume any responsibility or obligation for the altered documents.

Customers are responsible for complying with safety standards and taking safety measures when using Huaguan Semiconductor products for system design and machine manufacturing. You will bear all the following responsibilities: Select the appropriate Huaguan Semiconductor products for your application; Design, validate and test your application; Ensure that your application meets the appropriate standards and any other safety, security or other requirements. To avoid the occurrence of potential risks that may lead to personal injury or property loss.

Huaguan Semiconductor products have not been approved for applications in life support, military, aerospace and other fields, and Huaguan Semiconductor will not bear the consequences caused by the application of products in these fields. All problems, responsibilities and losses arising from the user's use beyond the applicable area of the product shall be borne by the user and have nothing to do with Huaguan Semiconductor, and the user shall not claim any compensation liability against Huaguan Semiconductor by the terms of this Agreement.

The technical and reliability data (including data sheets), design resources (including reference designs), application or other design suggestions, network tools, safety information and other resources provided for the performance of semiconductor products produced by Huaguan Semiconductor are not guaranteed to be free from defects and no warranty, express or implied, is made. The use of testing and other quality control technologies is limited to the quality assurance scope of Huaguan Semiconductor. Not all parameters of each device need to be tested.

The documentation of Huaguan Semiconductor authorizes you to use these resources only for developing the application of the product described in this document. You have no right to use any other Huaguan Semiconductor intellectual property rights or any third party intellectual property rights. It is strictly forbidden to make other copies or displays of these resources. You should fully compensate Huaguan Semiconductor and its agents for any claims, damages, costs, losses and debts caused by the use of these resources. Huaguan Semiconductor accepts no liability for any loss or damage caused by infringement.

单击下面可查看定价，库存，交付和生命周期等信息

[>>HGSEMI\(华冠\)](#)