

## 1.5MHz Zero-Drift CMOS Rail-to-Rail IO Opamp with RF Filter

### Features

- Single-Supply Operation from +1.8V ~ +5.5V
- Rail-to-Rail Input / Output
- Gain-Bandwidth Product: 1.5MHz (Typ. @25°C)
- Low Input Bias Current: 20pA (Typ. @25°C)
- Low Offset Voltage: 5uV (Max. @25°C)
- Quiescent Current: 320µA per Amplifier (Typ.)
- Operating Temperature: -40°C ~ +125°C
- Zero Drift: 0.05µV/°C (Max.)
- Embedded RF Anti-EMI Filter
- Small Package:

OPA335 Available in SOT23-5 and SOP-8 Packages

OPA2335 Available in MSOP8 and SOP-8 Packages

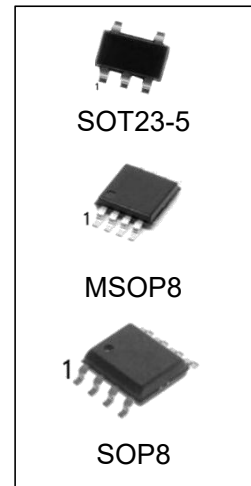

### Ordering Information

DEVICE	Package Type	MARKING	Packing	Packing Qty
OPA335M5/TR	SOT23-5	A335	REEL	3000pcs/reel
OPA335M/TR	SOP-8	OPA335	REEL	2500pcs/reel
OPA2335M/TR	SOP-8	OPA2335	REEL	2500pcs/reel
OPA2335MM/TR	MSOP-8	A2335	REEL	3000pcs/reel

## General Description

The OPAX335 amplifier is single/dual supply, micro-power, zero-drift CMOS operational amplifiers, the amplifiers offer bandwidth of 1.5MHz, rail-to-rail inputs and outputs, and single-supply operation from 2.1V to 5.5V. OPAX335 uses chopper stabilized technique to provide very low offset voltage (less than 5 $\mu$ V maximum) and near zero drift over temperature. Low quiescent supply current of 320 $\mu$ A per amplifier and very low input bias current of 20pA make the devices an ideal choice for low offset, low power consumption and high impedance applications. The OPAX335 offers excellent CMRR without the crossover associated with traditional complementary input stages. This design results in superior performance for driving analog-to-digital converters (ADCs) without degradation of differential linearity.

The OPA335 is available in SOT23-5 and SOP8 packages. And the OPA2335 is available in MSOP8 and SOP8 packages. The extended temperature range of -40 $^{\circ}$ C to +125 $^{\circ}$ C over all supply voltages offers additional design flexibility.

## Applications

- Transducer Application
- Temperature Measurements
- Electronics Scales
- Handheld Test Equipment
- Battery-Powered Instrumentation

## Pin Configuration

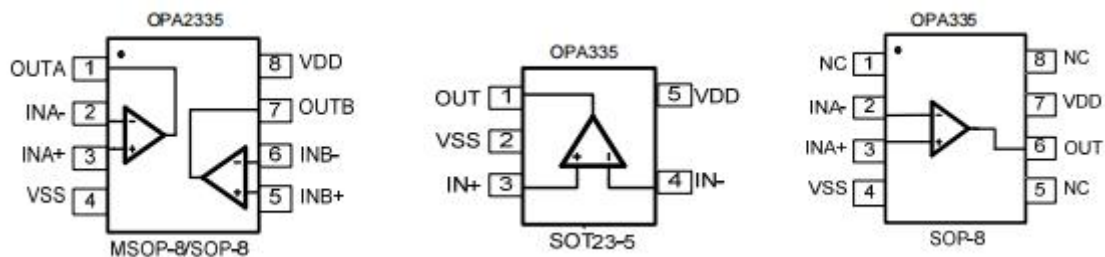

Figure 1. Pin Assignment Diagram

**Absolute Maximum Ratings**

Condition		Min	Max
Power Supply Voltage (VDD to Vss)		-0.5V	+7.5V
Analog Input Voltage (IN+ or IN-)		Vss-0.5V	VDD+0.5V
PDB Input Voltage		Vss-0.5V	+7V
Operating Temperature Range		-45°C	+125°C
Junction Temperature		-	+160°C
Storage Temperature Range		-55°C	+150°C
Lead Temperature (soldering, 10sec)		-	+260°C
<b>Package Thermal Resistance (TA=+25°C)</b>	SOP-8, $\theta_{JA}$	-	125°C/W
	MSOP-8, $\theta_{JA}$	-	216°C/W
	SOT23-5, $\theta_{JA}$	-	190°C/W
<b>ESD Susceptibility</b>	HBM	-	6KV
	MM	-	400V

**Note:** Stress greater than those listed under Absolute Maximum Ratings may cause permanent damage to the device. This is a stress rating only and functional operation of the device at these or any other conditions outside those indicated in the operational sections of this specification are not implied. Exposure to absolute maximum rating conditions for extended periods may affect reliability.

## Electrical Characteristics

( At  $V_S = 5V$ ,  $T_A = +25^{\circ}C$ ,  $V_{CM} = V_S/2$ ,  $R_L = 10k\Omega$ , unless otherwise noted.)

PARAMETER	CONDITIONS	MIN	TYP	MAX	UNITS
<b>INPUT CHARACTERISTICS</b>					
Input Offset Voltage (VOS)			1	10	$\mu V$
Input Bias Current (IB)			20		pA
Input Offset Current (IOS)			10		pA
Common-Mode Rejection Ratio (CMRR)	$V_{CM} = 0V$ to $5V$		110		dB
Large Signal Voltage Gain (AVO)	$R_L = 10k\Omega$ , $V_O = 0.3V$ to $4.7V$		145		dB
Input Offset Voltage Drift ( $\Delta V_{OS}/\Delta T$ )			50		nV/ $^{\circ}C$
<b>OUTPUT CHARACTERISTICS</b>					
Output Voltage High (VOH)	$R_L = 100k\Omega$ to $-V_S$		4.998		V
	$R_L = 10k\Omega$ to $-V_S$		4.994		V
Output Voltage Low (VOL)	$R_L = 100k\Omega$ to $+V_S$		2		mV
	$R_L = 10k\Omega$ to $+V_S$		5		mV
Short Circuit Limit (ISC)	$R_L = 10\Omega$ to $-V_S$		43		mA
Output Current (IO)			30		mA
<b>POWER SUPPLY</b>					
Power Supply Rejection Ratio (PSRR)	$V_S = 2.5V$ to $5.5V$		115		dB
Quiescent Current (IQ)	$V_O = 0V$ , $R_L = 0\Omega$		320		$\mu A$
<b>DYNAMIC PERFORMANCE</b>					
Gain-Bandwidth Product (GBP)	$G = +100$		350		MHz
Slew Rate (SR)	$R_L = 10k\Omega$		0.2		V/ $\mu s$
Over;pad Recovery Time			0.10		ms
<b>NOISE PERFORMANCE</b>					
Voltage Noise ( $e_n$ p-p)	0Hz to 10Hz		1.1		$\mu V_{P-P}$
Voltage Noise Density ( $e_n$ )	$f = 1kHz$		70		nV/ $\sqrt{Hz}$

Typical Performance characteristics

Large Signal Transient Response at +5V

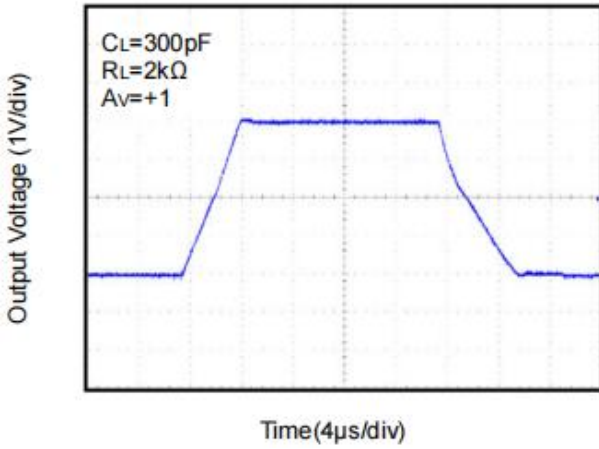

Large Signal Transient Response at +2.5V

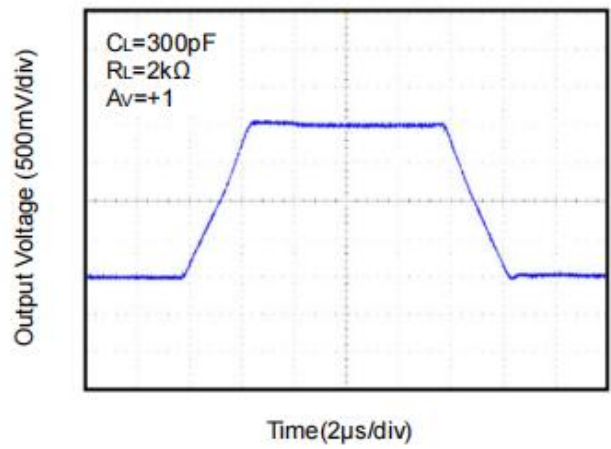

Small Signal Transient Response at +5V

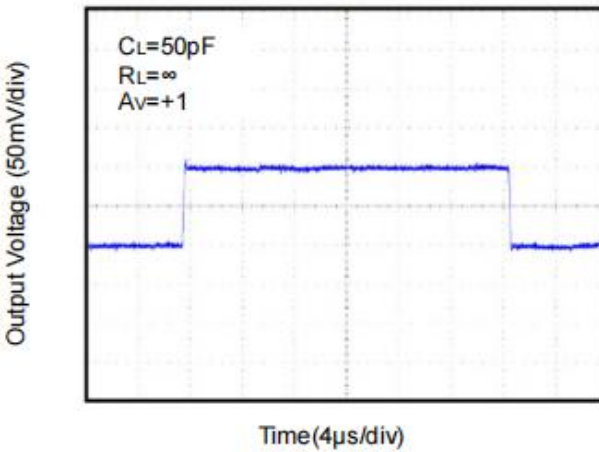

Small Signal Transient Response at +2.5V

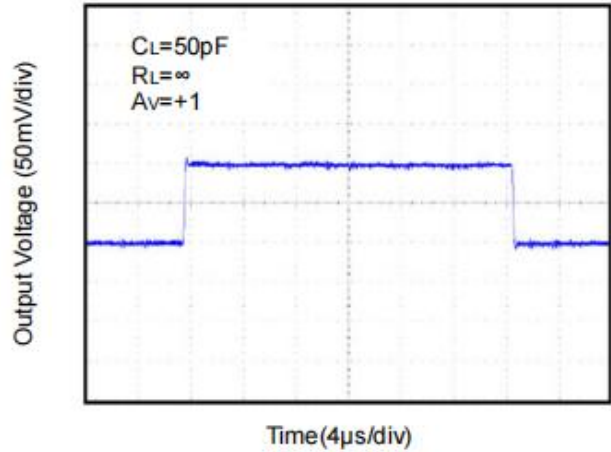

Closed Loop Gain vs. Frequency at +5V

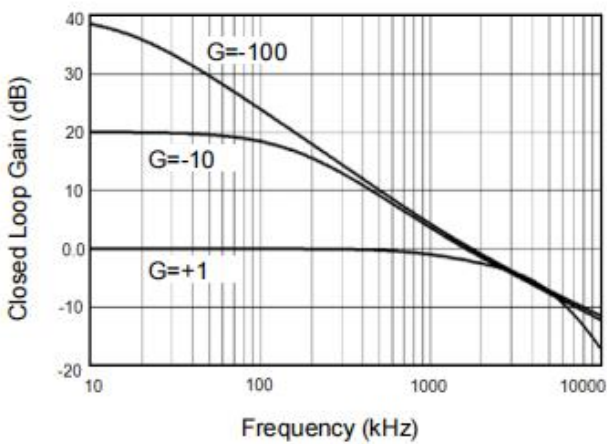

Closed Loop Gain vs. Frequency at +2.5V

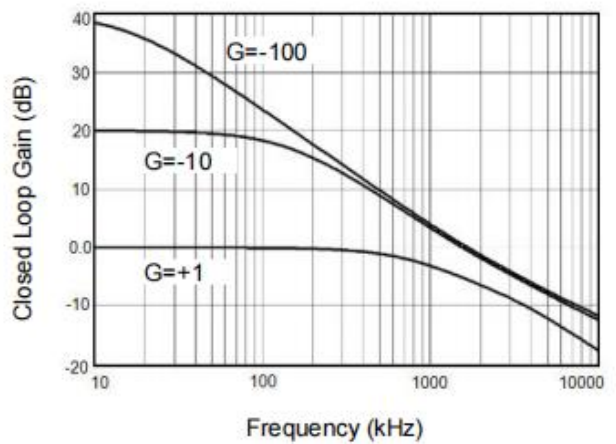

Typical Performance characteristics

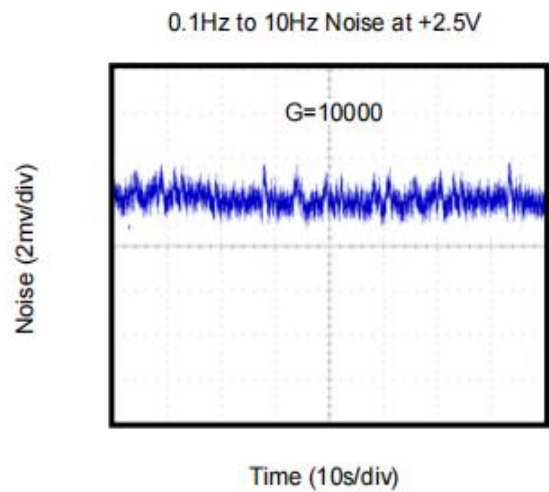
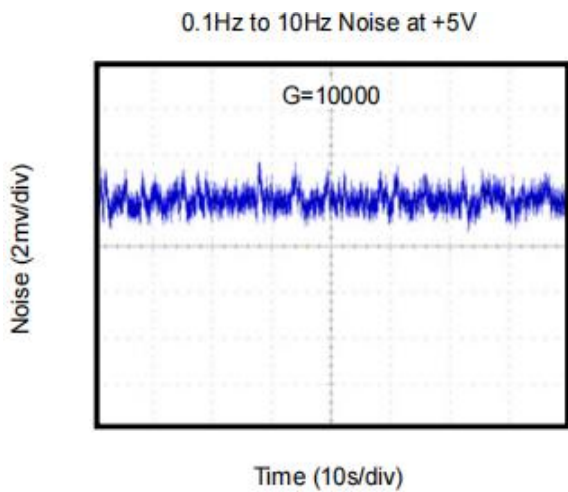
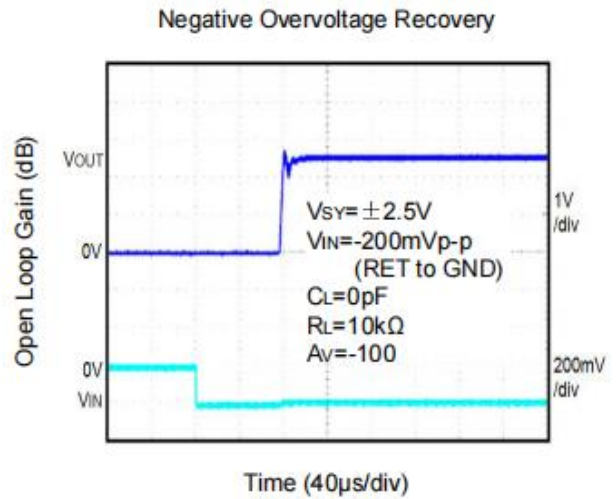
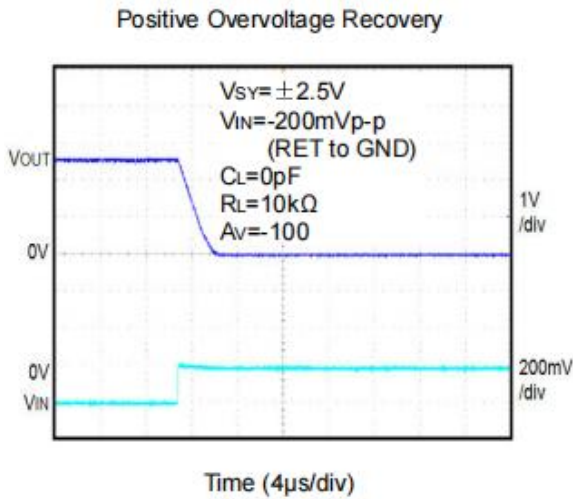
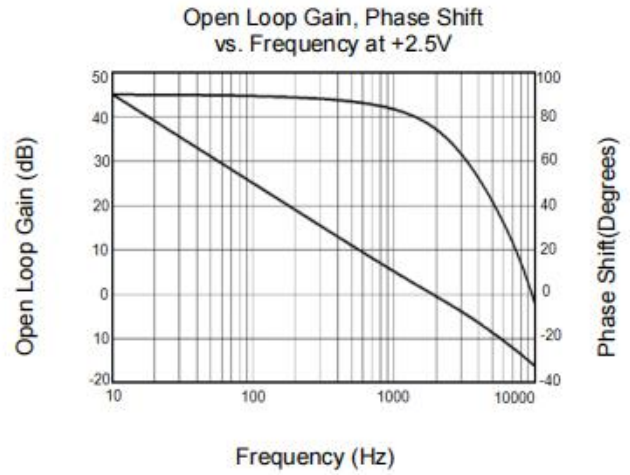
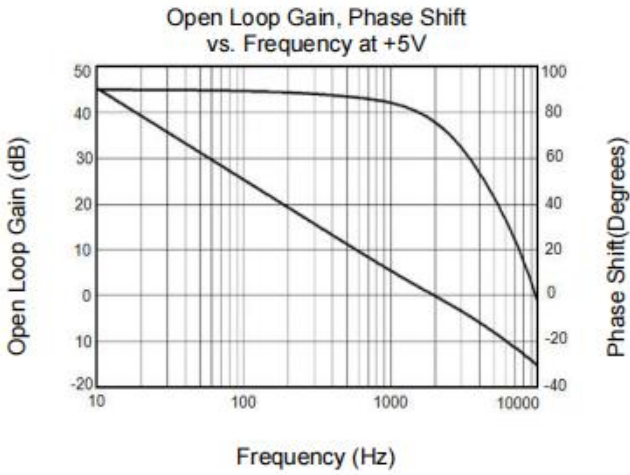

## Application Note

### Size

OPAx335 series op amps are unity-gain stable and suitable for a wide range of general-purpose applications. The small footprints of the OPAx335 series packages save space on printed circuit boards and enable the design of smaller electronic products.

### Power Supply Bypassing and Board Layout

OPAx335 series operates from a single 2.1V to 5.5V supply or dual  $\pm 1.05\text{V}$  to  $\pm 2.75\text{V}$  supplies. For best performance, a  $0.1\mu\text{F}$  ceramic capacitor should be placed close to the VDD pin in single supply operation. For dual supply operation, both VDD and VSS supplies should be bypassed to ground with separate  $0.1\mu\text{F}$  ceramic capacitors.

### Low Supply Current

The low supply current (typical  $320\mu\text{A}$  per channel) of OPAx335 series will help to maximize battery life. They are ideal for battery powered systems

### Operating Voltage

OPAx335 series operate under wide input supply voltage (2.1V to 5.5V). In addition, all temperature specifications apply from  $-40^\circ\text{C}$  to  $+125^\circ\text{C}$ . Most behavior remains unchanged throughout the full operating voltage range. These guarantees ensure operation throughout the single Li-Ion battery lifetime

### Rail-to-Rail Input

The input common-mode range of OPAx335 series extends  $100\text{mV}$  beyond the supply rails ( $V_{SS}-0.1\text{V}$  to  $V_{DD}+0.1\text{V}$ ). This is achieved by using complementary input stage. For normal operation, inputs should be limited to this range.

### Rail-to-Rail Output

Rail-to-Rail output swing provides maximum possible dynamic range at the output. This is particularly important when operating in low supply voltages. The output voltage of OPAx335 series can typically swing to less than  $5\text{mV}$  from supply rail in light resistive loads ( $>100\text{k}\Omega$ ), and  $60\text{mV}$  of supply rail in moderate resistive loads ( $10\text{k}\Omega$ ).

### Capacitive Load Tolerance

The OPAx335 family is optimized for bandwidth and speed, not for driving capacitive loads. Output capacitance will create a pole in the amplifier's feedback path, leading to excessive peaking and potential oscillation. If dealing with load capacitance is a requirement of the application, the two strategies to consider are (1) using a small resistor in series with the amplifier's output and the load capacitance and (2) reducing the bandwidth of the amplifier's feedback loop by increasing the overall noise gain.

Figure 2. shows a unity gain follower using the series resistor strategy. The resistor isolates the output from the capacitance and, more importantly, creates a zero in the feedback path that compensates for the pole created by the output capacitance.

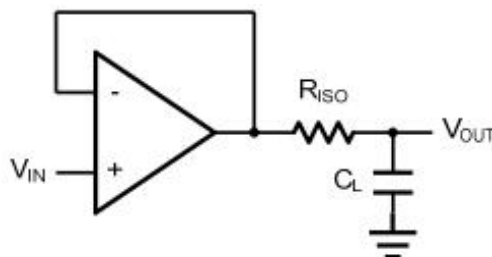

Figure 2. Indirectly Driving a Capacitive Load Using Isolation Resistor

The bigger the  $R_{ISO}$  resistor value, the more stable  $V_{OUT}$  will be. However, if there is a resistive load  $R_L$  in parallel with the capacitive load, a voltage divider (proportional to  $R_{ISO}/R_L$ ) is formed, this will result in a gain error.

The circuit in Figure 3 is an improvement to the one in Figure 2.  $R_F$  provides the DC accuracy by feed-forward the  $V_{IN}$  to  $R_L$ .  $C_F$  and  $R_{ISO}$  serve to counteract the loss of phase margin by feeding the high frequency component of the output signal back to the amplifier's inverting input, thereby preserving the phase margin in the overall feedback loop. Capacitive drive can be increased by increasing the value of  $C_F$ . This in turn will slow down the pulse response.

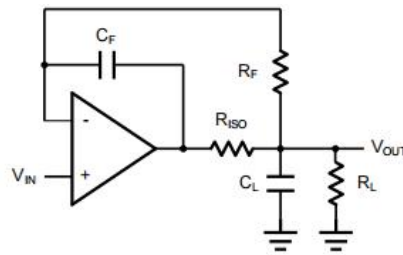

Figure 3. Indirectly Driving a Capacitive Load with DC Accuracy

## Typical Application Circuits

### Differential amplifier

The differential amplifier allows the subtraction of two input voltages or cancellation of a signal common to the two inputs. It is useful as a computational amplifier in making a differential to single-end conversion or in rejecting a common mode signal. Figure 4. shown the differential amplifier using OPAx335.

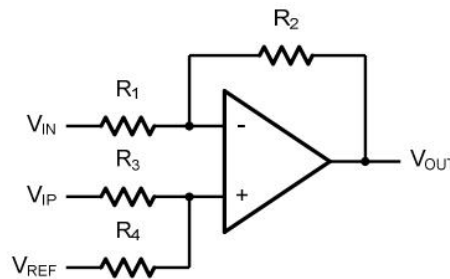

Figure 4. Differential Amplifier

$$V_{OUT} = \left( \frac{R_1 + R_2}{R_3 + R_4} \right) \frac{R_4}{R_1} V_{IN} - \frac{R_2}{R_1} V_{IP} + \left( \frac{R_1 + R_2}{R_3 + R_4} \right) \frac{R_3}{R_1} V_{REF}$$

If the resistor ratios are equal (i.e.  $R_1=R_3$  and  $R_2=R_4$ ), then

$$V_{OUT} = \frac{R_2}{R_1} (V_{IP} - V_{IN}) + V_{REF}$$



## Low Pass Active Filter

The low pass active filter is shown in Figure 5. The DC gain is defined by  $-R_2/R_1$ . The filter has a -20dB/decade roll-off after its corner frequency  $f_C=1/(2\pi R_3 C_1)$ .

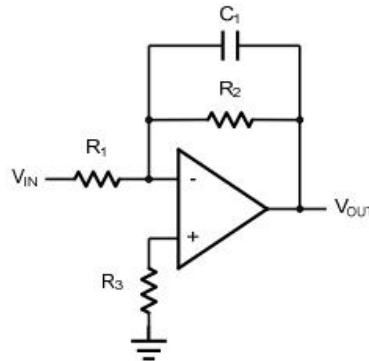

Figure 5. Low Pass Active Filter

## Instrumentation Amplifier

The triple OPAx335 can be used to build a three-op-amp instrumentation amplifier as shown in Figure 6. The amplifier in Figure 6 is a high input impedance differential amplifier with gain of  $R_2/R_1$ . The two differential voltage followers assure the high input impedance of the amplifier.

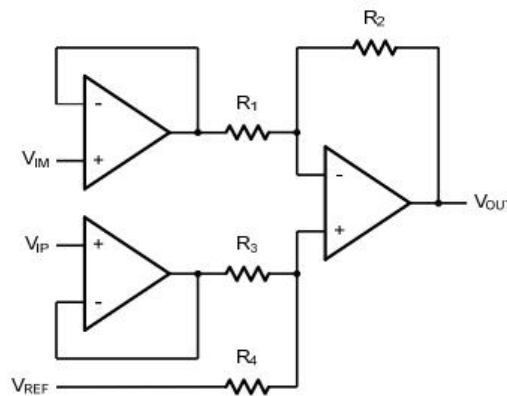
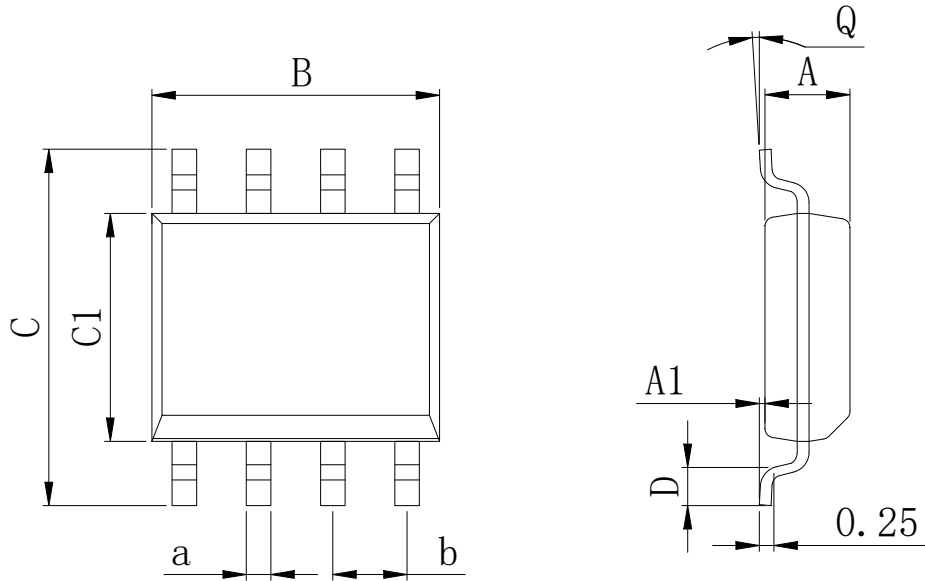

Figure 6. Instrument Amplifier

## Physical Dimensions

### SOP8



Dimensions In Millimeters(SOP8)

Symbol:	A	A1	B	C	C1	D	Q	a	b
Min:	1.35	0.05	4.90	5.80	3.80	0.40	0°	0.35	1.27 BSC
Max:	1.55	0.20	5.10	6.20	4.00	0.80	8°	0.45	

### MSOP8

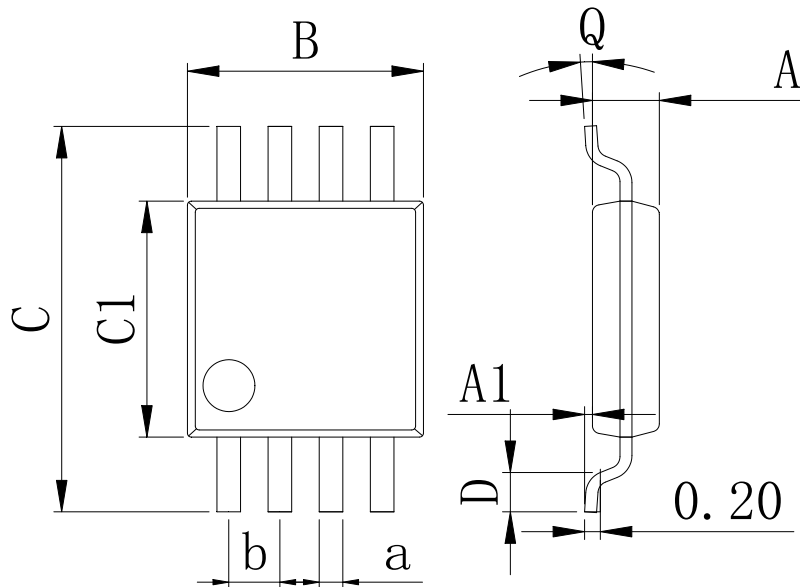

Dimensions In Millimeters(MSOP8)

Symbol:	A	A1	B	C	C1	D	Q	a	b
Min:	0.80	0.05	2.90	4.75	2.90	0.35	0°	0.25	0.65 BSC
Max:	0.90	0.20	3.10	5.05	3.10	0.75	8°	0.35	

**Physical Dimensions**

SOT23-5

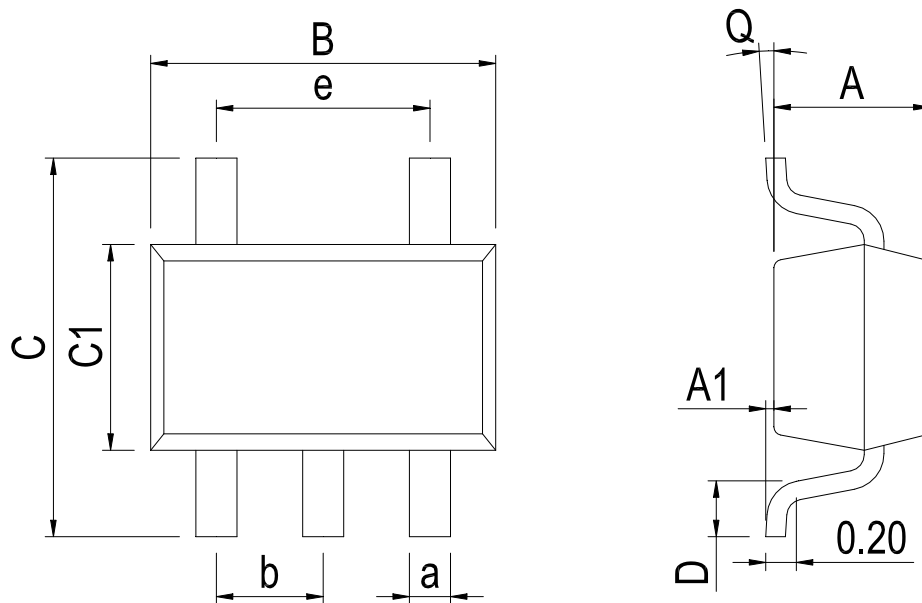

Dimensions In Millimeters(SOT23-5)										
Symbol:	A	A1	B	C	C1	D	Q	a	b	e
Min:	1.05	0.00	2.82	2.65	1.50	0.30	0°	0.30	0.95 BSC	1.90 BSC
Max:	1.15	0.15	3.02	2.95	1.70	0.60	8°	0.40		

**IMPORTANT STATEMENT:**

Huaguan Semiconductor reserves the right to change its products and services without notice. Before ordering, the customer shall obtain the latest relevant information and verify whether the information is up to date and complete. Huaguan Semiconductor does not assume any responsibility or obligation for the altered documents.

Customers are responsible for complying with safety standards and taking safety measures when using Huaguan Semiconductor products for system design and machine manufacturing. You will bear all the following responsibilities: select the appropriate Huaguan Semiconductor products for your application; Design, validate and test your application; Ensure that your application meets the appropriate standards and any other safety, security or other requirements. To avoid the occurrence of potential risks that may lead to personal injury or property loss.

Huaguan Semiconductor products have not been approved for applications in life support, military, aerospace and other fields, and Huaguan Semiconductor will not bear the consequences caused by the application of products in these fields.

The technical and reliability data (including data sheets), design resources (including reference designs), application or other design suggestions, network tools, safety information and other resources provided for the performance of semiconductor products produced by Huaguan Semiconductor are not guaranteed to be free from defects and no warranty, express or implied, is made. The use of testing and other quality control technologies is limited to the quality assurance scope of Huaguan Semiconductor. Not all parameters of each device need to be tested.

The documentation of Huaguan Semiconductor authorizes you to use these resources only for developing the application of the product described in this document. You have no right to use any other Huaguan Semiconductor intellectual property rights or any third party intellectual property rights. It is strictly forbidden to make other copies or displays of these resources. You should fully compensate Huaguan Semiconductor and its agents for any claims, damages, costs, losses and debts caused by the use of these resources. Huaguan Semiconductor accepts no liability for any loss or damage caused by infringement.

单击下面可查看定价，库存，交付和生命周期等信息

[>>HGSEMI\(华冠\)](#)