

## 1 MHz Bandwidth Low Power Op Amp

### Features

- 1 MHz Gain Bandwidth Product (typ.)
- Rail-to-Rail Input/Output
- Supply Voltage: 1.8V to 5.5V
- Supply Current:  $I_Q = 100 \mu\text{A}$  (typ.)
- 90° Phase Margin (typ.)
- Temperature Range:
  - Industrial: -40°C to +85°C
  - Extended: -40°C to +125°C
- Available in Single, Dual and Quad Packages

### Applications

- Automotive
- Portable Equipment
- Photodiode Pre-amps
- Analog Filters
- Notebooks and PDAs
- Battery-Powered Systems

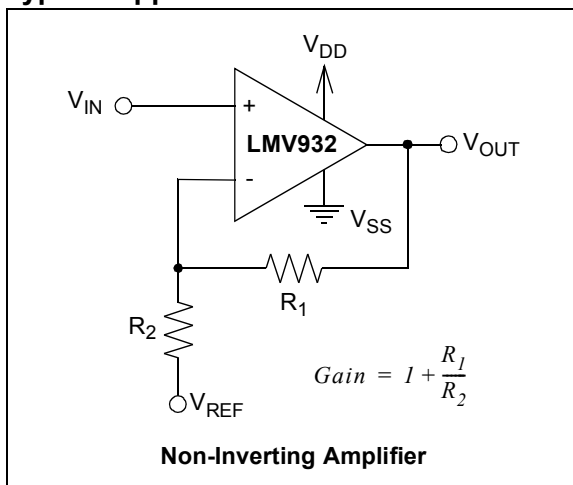
### Description

LMV932 operational amplifiers (op amps) is specifically designed for general-purpose applications. This family has a 1 MHz gain bandwidth product and 90° phase margin (typ.). It also maintains 45° phase margin (typ.) with 500 pF capacitive load. This family operates from a single supply voltage as low as 1.8V, while drawing 100  $\mu\text{A}$  (typ.) quiescent current. Additionally, the LM932 supports rail-to-rail input and output swing with a common mode input voltage range of  $V_{DD} + 300 \text{ mV}$  to  $V_{SS} - 300 \text{ mV}$ . This family of operational amplifiers is designed with Microchip's advanced CMOS process.

The LMV932 family is available in the industrial and extended temperature ranges. It also has a power supply range of 1.8V to 5.5V.

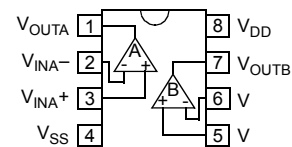
### Package Types

### Typical Application



### LMV932

PDIP, SOIC, MSOP



## 1.0 ELECTRICAL CHARACTERISTICS

### Absolute Maximum Ratings †

$V_{DD} - V_{SS}$ .....	7.0V
All Inputs and Outputs .....	$V_{SS} - 0.3V$ to $V_{DD} + 0.3V$
Difference Input Voltage .....	$ V_{DD} - V_{SS} $
Output Short Circuit Current .....	continuous
Current at Input Pins .....	$\pm 2$ mA
Current at Output and Supply Pins .....	$\pm 30$ mA
Storage Temperature .....	$-65^{\circ}\text{C}$ to $+150^{\circ}\text{C}$
Maximum Junction Temperature ( $T_J$ ) .....	$+150^{\circ}\text{C}$
ESD Protection On All Pins (HBM;MM) .....	$\geq 4$ kV; 200V

† **Notice:** Stresses above those listed under “Maximum Ratings” may cause permanent damage to the device. This is a stress rating only and functional operation of the device at those or any other conditions above those indicated in the operational listings of this specification is not implied. Exposure to maximum rating conditions for extended periods may affect device reliability.

## PIN FUNCTION TABLE

Name	Function
$V_{INA+}, V_{INB}$	Non-inverting Inputs
$V_{INA-}, V_{INB}$	Inverting Inputs
$V_{DD}$	Positive Power Supply
$V_{SS}$	Negative Power Supply
$V_{OUTA}, V_{OUTB}$	Outputs

## DC ELECTRICAL SPECIFICATIONS

**Electrical Characteristics:** Unless otherwise indicated,  $T_A = +25^{\circ}\text{C}$ ,  $V_{DD} = +1.8V$  to  $+5.5V$ ,  $V_{SS} = \text{GND}$ ,  $V_{CM} = V_{DD}/2$ ,  $R_L = 10$  k $\Omega$  to  $V_{DD}/2$ , and  $V_{OUT} \sim V_{DD}/2$ .

Parameters	Sym	Min	Typ	Max	Units	Conditions
<b>Input Offset</b>						
Input Offset Voltage	$V_{OS}$	-7.0	—	+7.0	mV	$V_{CM} = V_{SS}$
Input Offset Drift with Temperature	$\Delta V_{OS}/\Delta T_A$	—	$\pm 2.0$	—	$\mu\text{V}/^{\circ}\text{C}$	$T_A = -40^{\circ}\text{C}$ to $+125^{\circ}\text{C}$ , $V_{CM} = V_{SS}$
Power Supply Rejection	PSRR	—	86	—	dB	$V_{CM} = V_{SS}$
<b>Input Bias Current and Impedance</b>						
Input Bias Current:	$I_B$	—	$\pm 1.0$	—	pA	$T_A = +85^{\circ}\text{C}$ $T_A = +125^{\circ}\text{C}$
Industrial Temperature	$I_B$	—	19	—	pA	
Extended Temperature	$I_B$	—	1100	—	pA	
Input Offset Current	$I_{OS}$	—	$\pm 1.0$	—	pA	
Common Mode Input Impedance	$Z_{CM}$	—	$10^{13}  6$	—	$\Omega  \mu\text{F}$	
Differential Input Impedance	$Z_{DIFF}$	—	$10^{13}  3$	—	$\Omega  \mu\text{F}$	
<b>Common Mode</b>						
Common Mode Input Range	$V_{CMR}$	$V_{SS} - 0.3$	—	$V_{DD} + 0.3$	V	
Common Mode Rejection Ratio	CMRR	60	76	—	dB	$V_{CM} = -0.3V$ to $5.3V$ , $V_{DD} = 5V$
<b>Open-Loop Gain</b>						
DC Open-Loop Gain (large signal)	$A_{OL}$	88	112	—	dB	$V_{OUT} = 0.3V$ to $V_{DD} - 0.3V$ , $V_{CM} = V_{SS}$
<b>Output</b>						
Maximum Output Voltage Swing	$V_{OL}, V_{OH}$	$V_{SS} + 25$	—	$V_{DD} - 25$	mV	$V_{DD} = 5.5V$
Output Short-Circuit Current	$I_{SC}$	—	$\pm 6$	—	mA	$V_{DD} = 1.8V$
		—	$\pm 23$	—	mA	$V_{DD} = 5.5V$
<b>Power Supply</b>						
Supply Voltage	$V_{DD}$	1.8	—	5.5	V	
Quiescent Current per Amplifier	$I_Q$	50	100	170	$\mu\text{A}$	$I_O = 0$ , $V_{DD} = 5.5V$ , $V_{CM} = 5V$

**AC ELECTRICAL SPECIFICATIONS**

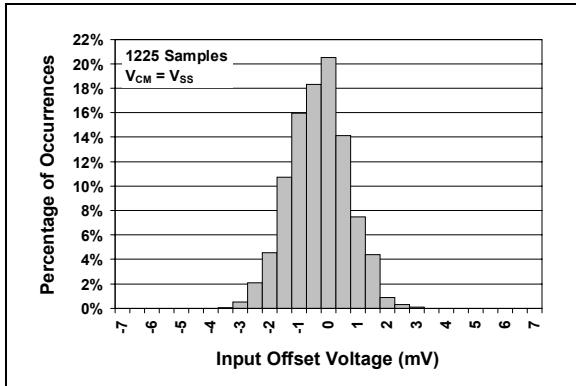
**Electrical Characteristics:** Unless otherwise indicated,  $T_A = +25^\circ\text{C}$ ,  $V_{DD} = +1.8$  to  $5.5\text{V}$ ,  $V_{SS} = \text{GND}$ ,  $V_{CM} = V_{DD}/2$ ,  $V_{OUT} \approx V_{DD}/2$ ,  $R_L = 10\text{ k}\Omega$  to  $V_{DD}/2$ , and  $C_L = 60\text{ pF}$ .

Parameters	Sym	Min	Typ	Max	Units	Conditions
<b>AC Response</b>						
Gain Bandwidth Product	GBWP	—	1.0	—	MHz	
Phase Margin	PM	—	90	—	°	G = +1
Slew Rate	SR	—	0.6	—	V/ $\mu\text{s}$	
<b>Noise</b>						
Input Noise Voltage	$E_{ni}$	—	6.1	—	$\mu\text{Vp-p}$	f = 0.1 Hz to 10 Hz
Input Noise Voltage Density	$e_{ni}$	—	28	—	nV/ $\sqrt{\text{Hz}}$	f = 1 kHz
Input Noise Current Density	$i_{ni}$	—	0.6	—	fA/ $\sqrt{\text{Hz}}$	f = 1 kHz

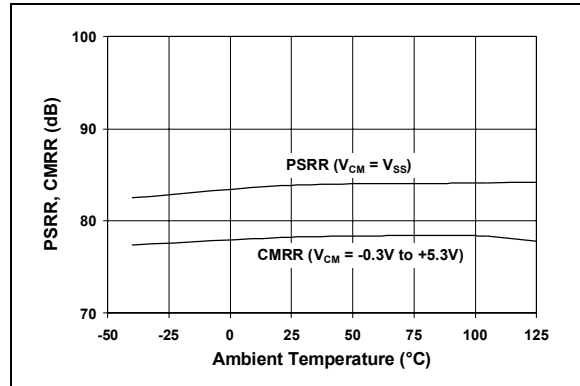
## 2.0 TYPICAL PERFORMANCE CURVES

**Note:** The graphs and tables provided following this note are a statistical summary based on a limited number of samples and are provided for informational purposes only. The performance characteristics listed herein are not tested or guaranteed. In some graphs or tables, the data presented may be outside the specified operating range (e.g., outside specified power supply range) and therefore outside the warranted range.

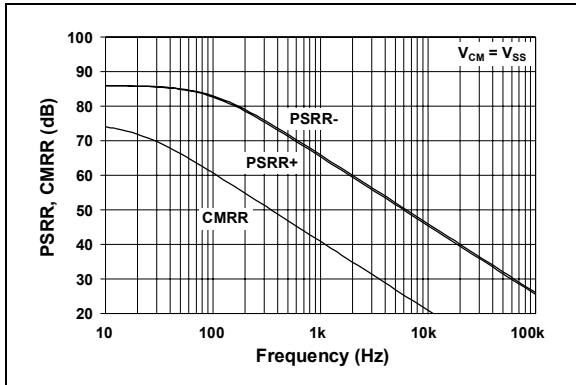
**Note:** Unless otherwise indicated,  $T_A = +25^\circ\text{C}$ ,  $V_{DD} = +1.8\text{V}$  to  $+5.5\text{V}$ ,  $V_{SS} = \text{GND}$ ,  $V_{CM} = V_{DD}/2$ ,  $V_{OUT} \approx V_{DD}/2$ ,  $R_L = 10\text{ k}\Omega$  to  $V_{DD}/2$ , and  $C_L = 60\text{ pF}$ .



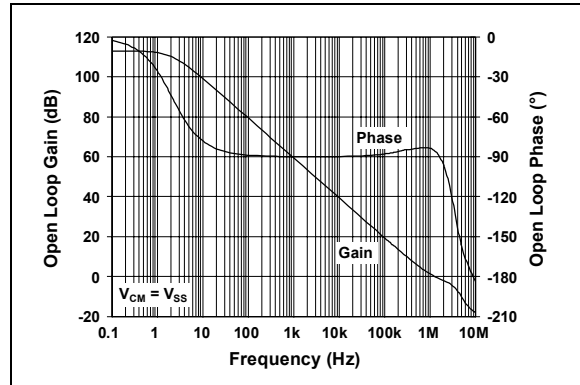
**FIGURE 2-1:** Input Offset Voltage Histogram.



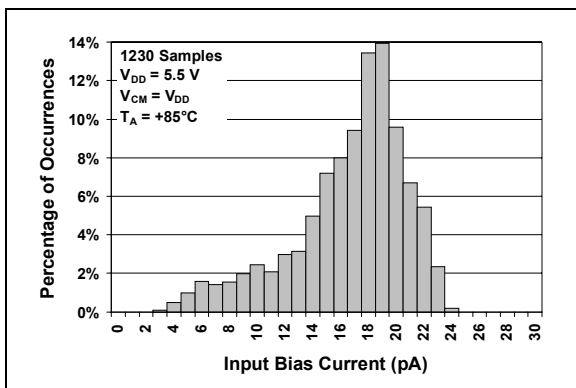
**FIGURE 2-4:** CMRR, PSRR vs. Ambient Temperature.



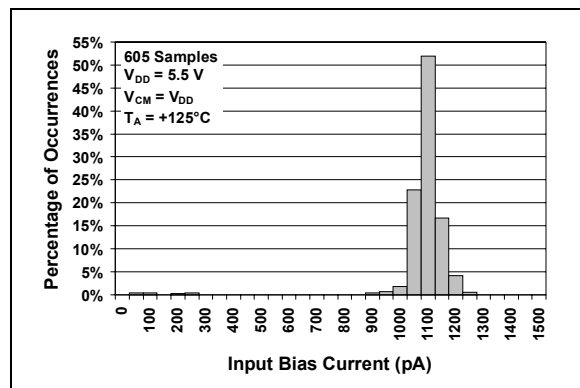
**FIGURE 2-2:** PSRR, CMRR vs. Frequency.



**FIGURE 2-5:** Open-Loop Gain, Phase vs. Frequency.

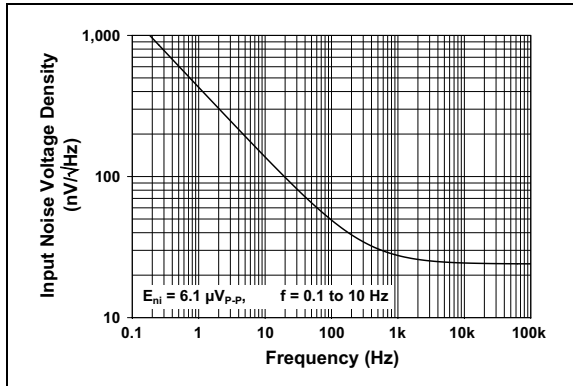


**FIGURE 2-3:** Input Bias Current at  $+85^\circ\text{C}$  Histogram.

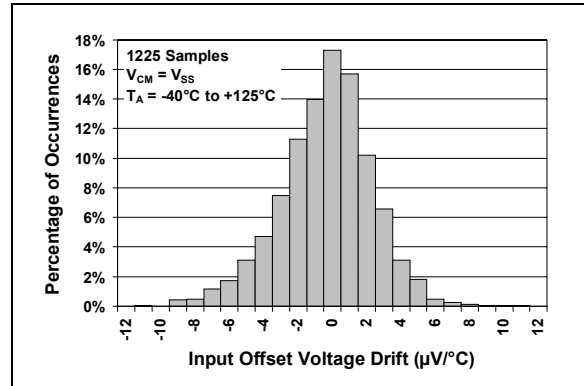


**FIGURE 2-6:** Input Bias Current at  $+125^\circ\text{C}$  Histogram.

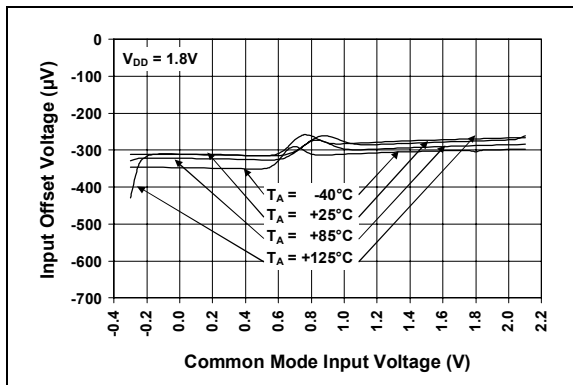
**Note:** Unless otherwise indicated,  $T_A = +25^\circ\text{C}$ ,  $V_{DD} = +1.8\text{V}$  to  $+5.5\text{V}$ ,  $V_{SS} = \text{GND}$ ,  $V_{CM} = V_{DD}/2$ ,  $V_{OUT} \approx V_{DD}/2$ ,  $R_L = 10\text{ k}\Omega$  to  $V_{DD}/2$ , and  $C_L = 60\text{ pF}$ .



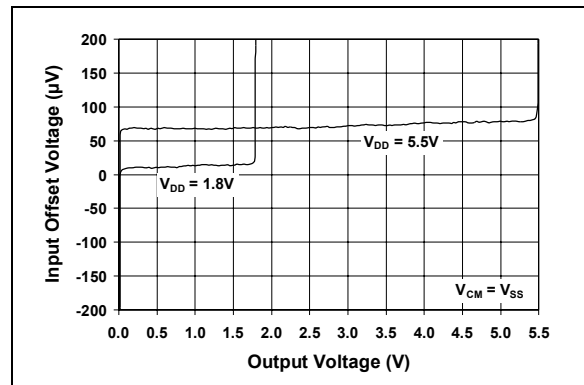
**FIGURE 2-7:** Input Noise Voltage Density vs. Frequency.



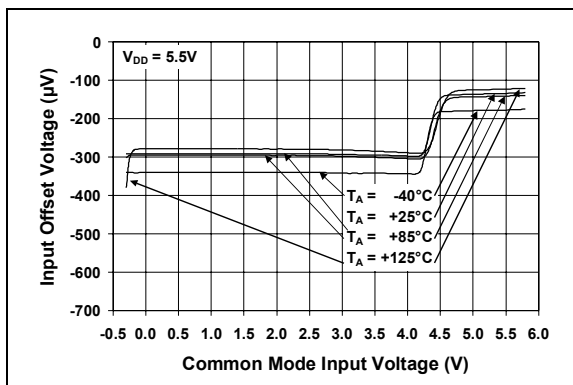
**FIGURE 2-10:** Input Offset Voltage Drift Histogram.



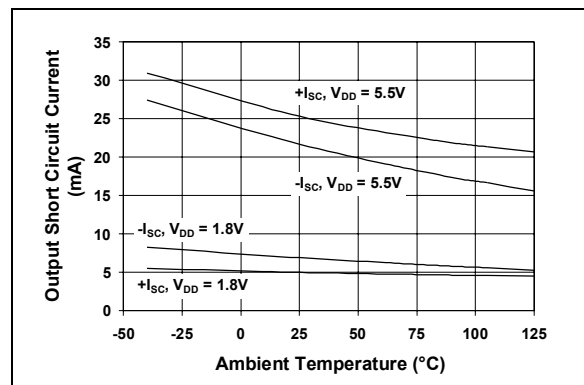
**FIGURE 2-8:** Input Offset Voltage vs. Common Mode Input Voltage at  $V_{DD} = 1.8\text{V}$ .



**FIGURE 2-11:** Input Offset Voltage vs. Output Voltage.

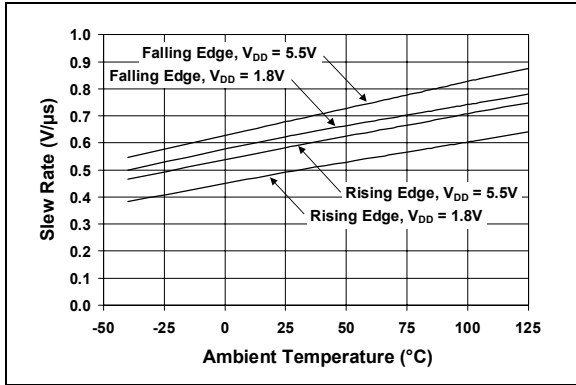


**FIGURE 2-9:** Input Offset Voltage vs. Common Mode Input Voltage at  $V_{DD} = 5.5\text{V}$ .

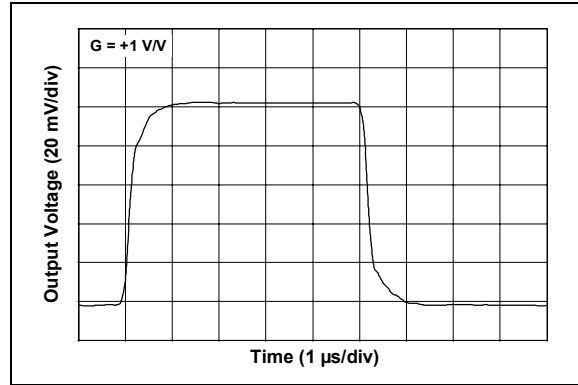


**FIGURE 2-12:** Output Short-Circuit Current vs. Ambient Temperature.

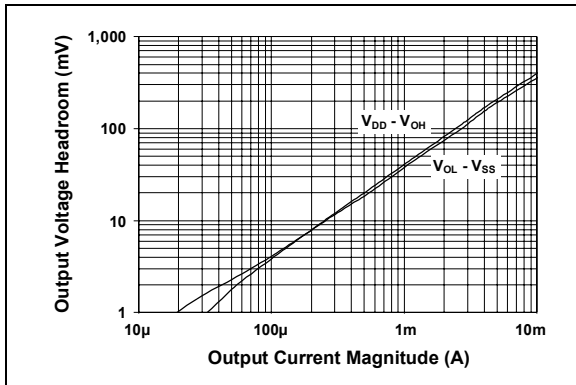
**Note:** Unless otherwise indicated,  $T_A = +25^\circ\text{C}$ ,  $V_{DD} = +1.8\text{V}$  to  $+5.5\text{V}$ ,  $V_{SS} = \text{GND}$ ,  $V_{CM} = V_{DD}/2$ ,  $V_{OUT} \approx V_{DD}/2$ ,  $R_L = 10\text{ k}\Omega$  to  $V_{DD}/2$ , and  $C_L = 60\text{ pF}$ .



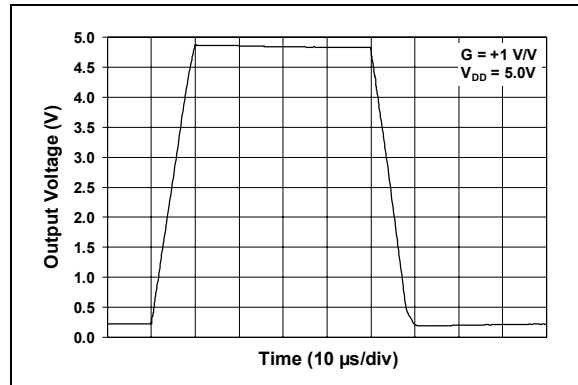
**FIGURE 2-13:** Slew Rate vs. Ambient Temperature.



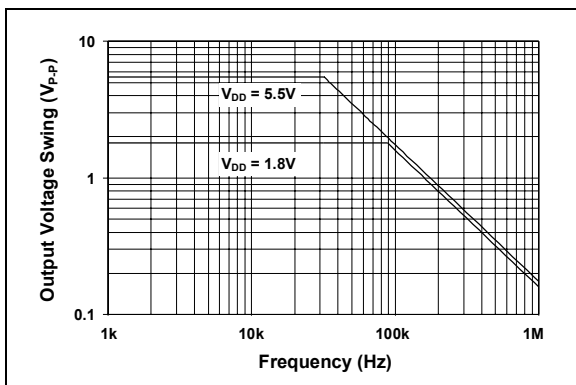
**FIGURE 2-16:** Small Signal Non-Inverting Pulse Response.



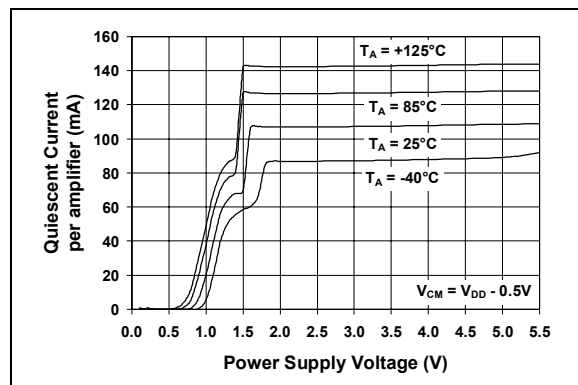
**FIGURE 2-14:** Output Voltage Headroom vs. Output Current Magnitude.



**FIGURE 2-17:** Large Signal Non-Inverting Pulse Response.



**FIGURE 2-15:** Output Voltage Swing vs. Frequency.



**FIGURE 2-18:** Quiescent Current vs. Power Supply Voltage.

单击下面可查看定价，库存，交付和生命周期等信息

[>>HGSEMI\(华冠\)](#)