



产 品 规 格 书

PRODUCT SPECIFICATION

客户名称 CUSTOMER: _____

产品型号 MODEL: QMB-09B-03 16Ω

客户料号 USER'S MODEL: _____

日 期 DATE: 2019-12-3

江苏华能电子有限公司			客户回签		
HUAWHA			CUSTOMER		
SERVE RATIVITY			CUSTOMER RATIGY		
拟制	审核	批准	检验	审核	批准
REPORT	CHECKED	APPROVED	TEST	CHECKED	APPROVED
王文娟	工稿用章	张长华			

江苏华能电子有限公司
 JIANGSU HUAWHA ELECTRONICS CO.,LTD
 地址：江苏省泰州市兴化市陈堡镇工业园区
 ADD:Chenbao Industrial Park, Chenbao Town, Xinghua,Taizhou City, Jiangsu China.
 电话 [TEL:0523-83710666](tel:0523-83710666) 传真 [FAX:0523-83724866](tel:0523-83724866)
 网址: www.huawha.com 邮箱: hndz_wwj@huawha.com

1.基本规格/General specification

项目/Item		规格/Spec	条件/Condition
1	额定电压 Rated voltage	3.0Vo-p	
2	工作电压 Operation voltage	1.5~5Vo-p	
3	声压 Sound Pressure Level=SPL	Min 80dB	测试环境：标准状态，标准驱动电路， 额定电压 测试距离：0.1m Standard State,Standard Drive Circuit. Rated voltage,Distance at 0.1m
4	电流 current	Max50mA	
5	振荡频率 Oscillation frequency	2700±300HZ	
6	电阻 Coil Resistance	16±5Ω	
7	工作温度范围 Operating Temperature	-20~+70℃	
8	保存温度范围 Storage temperature	-30~+80℃	
9	外部尺寸 Externals size (mm)	Φ9*H5.5	参阅附图 Refer to the attached drawing
10	重量 Mass	0.8g	
11	材质 Housing Material	PBT	

2.电气和声学测试条件/Electrical And Acoustical Measuring Condition**驱动电路/Recommended Driving Circuit****设置 Recommended Setting**

Resonant frequency, 1/2 duty cycle. Square wave.

Signal amplitude should be large enough to saturate the transistor.

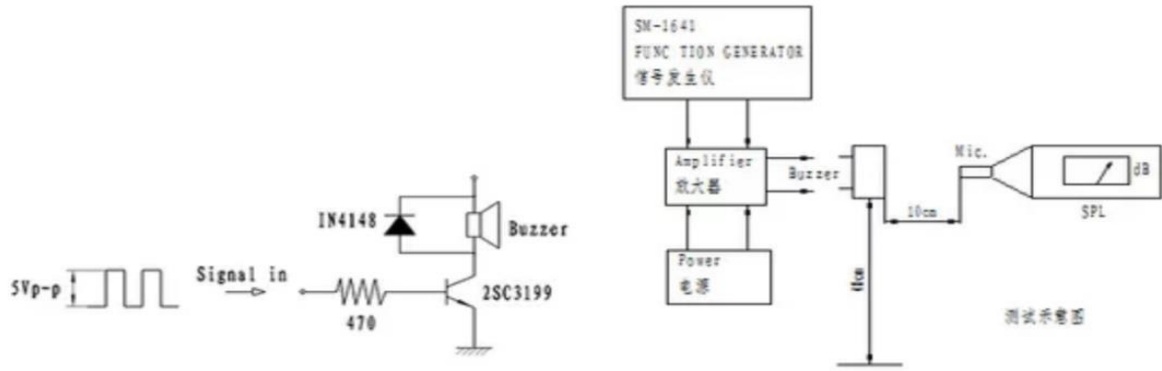

谐振频率是占空比为50%的方波，信号电压要足够让晶体管饱和和工作。

3.可靠性测试/Reliability Test

项目 ITEM	测试方法 TEST
1 高温试验 High Temperature Test	在+80°C ±2°C储存温度下存放 96 小时，恢复 2 小时后测试 After being placed in a chamber with +80±2°C for 96 hours and then being placed in normal condition for 2 hours
2 低温试验 Low Temperature Test	在-20°C ±2°C储存温度下存放 96 小时，恢复 2 小时后测试 After being placed in a chamber with -20±2°C for 96 hours and then being placed in normal condition for 2 hours
3 恒定湿热试验 Humidity Test	
4 温度变化试验 Temperature Cycle Test	<p>Make this test for 5 cycle without applying power, then expose to the room temperature for 2 hours 不加负载，按 5 次循环测试，然后在室温下恢复 2 小时</p>
5 振动试验 Vibration Test	<p>Amplitude:1.5mm Time :1min/axis</p> <p>Make this test for the directions of X, Y, Z for 2 hours each (total 6 hours). 振动频率 10-55Hz, 振幅 1.5mm, 在 X, Y, Z 3 个方向各 2 小时</p>
6 跌落试验 Drop Test	70cm 高自由掉落到 40mm 的木板上，每个方向三次 Drop on a hard wood board of 40mm thick, any directions, three times, at the height of 70cm

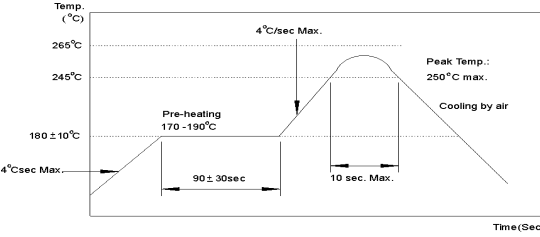
7	插针的抗拉强度试验 Terminal Strength Pulling Test	插针承受 1.0kg 拉力，负荷时间 5s The force 5 seconds of 1.0kg is applied to each terminal.
8	可焊性试验 Solder ability Test	焊锡温度 $255 \pm 5^{\circ}\text{C}$ ，浸润时间为 $3 \pm 0.5\text{s}$ ，试验后目测产品情况 Lead terminals are immersed in rosin for 5 seconds and then immersed in solder bath of $255 \pm 5^{\circ}\text{C}$ for 3 ± 0.5 seconds.
9	回流焊测试 Soldering Test	

4.尺寸图 Dimension

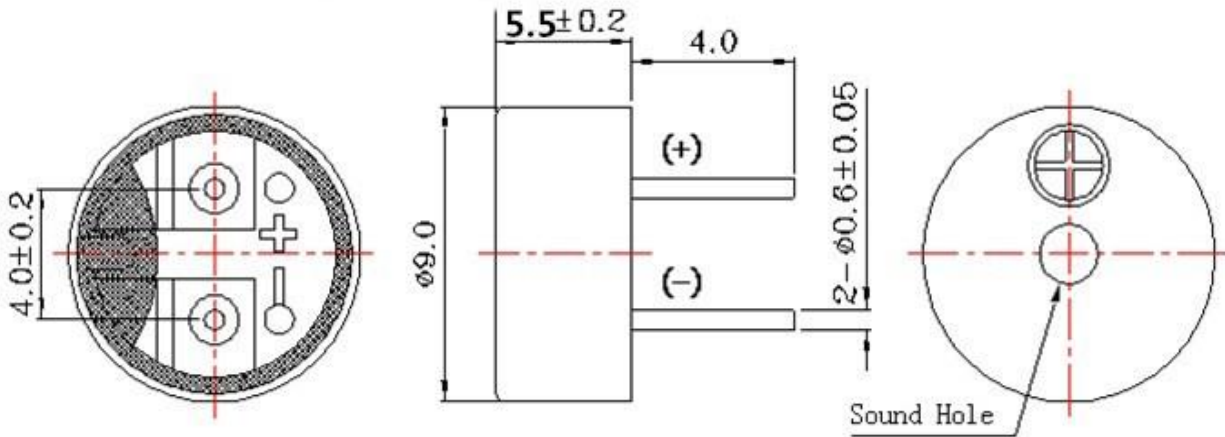

*Unit: mm; Tolerance: ± 0.3 mm Except Specified

*Housing Material: Black PBT

5.频率响应/Frequency Response

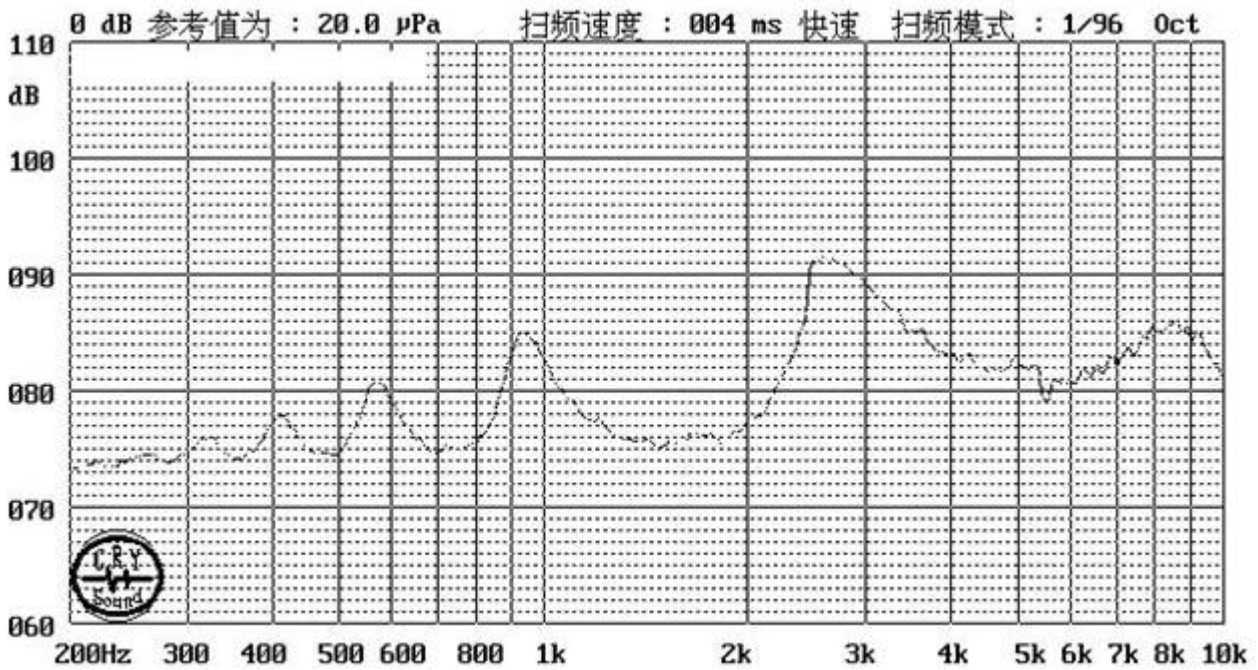

3.0Vo-p 50% duty Square wave,10cm

6.Sample Test

Model	QMB-09B-03	
Test condition	2700Hz dB=85 3.0V 16Ω	
Reference No.	阻抗 (Ω)	分贝 (dB)
1	16.1	94.1
2	16.6	88.2
3	17.2	89.0
4	16.7	89.6
5	18.1	86.3
6	17.6	89.2
7	16.8	90.1
8	17.6	89.6
9	17.4	89.4
10	18.1	86.7
Remark :		

7.包装 picking

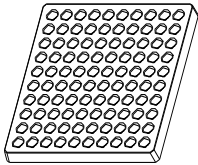
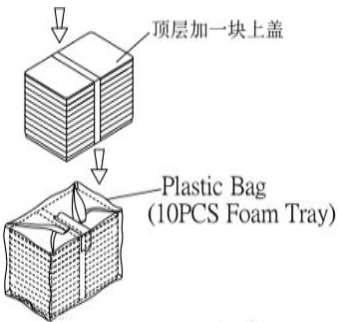
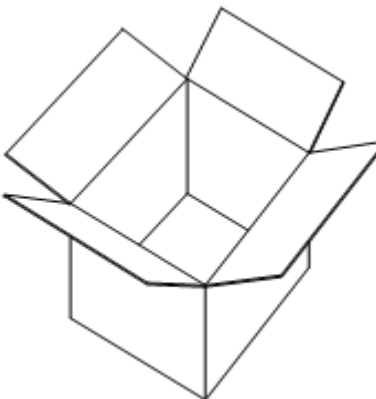
Item	Drawing	Qty(pcs.)	Material	Specification (mm)
Packing		100 (10×10)	PE	78×78×20
MiddleBox		1000 (10×100)	Paper	780×780×110
OuterBox		10000 (10×1000)	Paper	500×420×270

单击下面可查看定价，库存，交付和生命周期等信息

[>>HNDZ\(江苏华能电子\)](#)