

## High Sensitivity, Latching Digital Hall-effect Sensor ICs: SS361CT, SS461C

32309592

Issue A

Datasheet

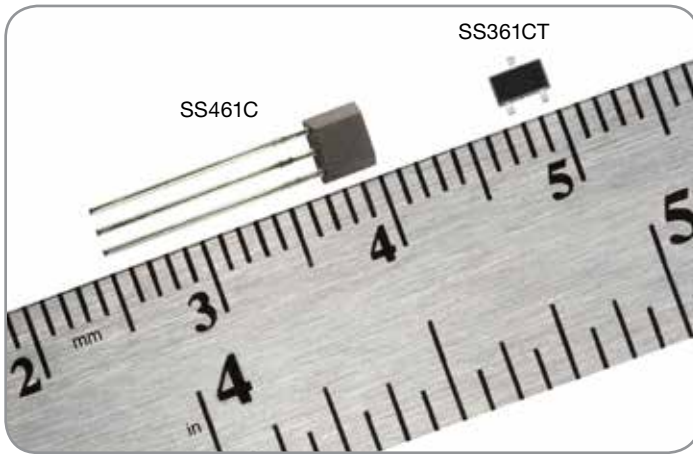

### DESCRIPTION

The SS361CT and SS461C High Sensitivity Latching Hall-effect Sensor ICs are small, sensitive, and versatile devices that are operated by the magnetic field from a permanent magnet or an electromagnet. They are designed to respond to alternating North and South poles. The SS361CT is turned on by a North pole while the SS461C is turned on by a South pole.

These products offer reverse polarity protection and deliver enhanced sensitivity of only 50 G typical, at 25 °C [77 °F], 80 G max. at -40 °C to 85 °C [-40 °F to 185 °F], and 95 G over the full temperature range, allowing the use of smaller, potentially lower-cost magnets or wider air gaps.

These products are available in three package styles:

- **SS361CT:** Subminiature SOT-23 surface-mount package on tape and reel which allows for compact design with automated component placement.
- **SS461C:** Flat TO-92-style package with straight leads in bulk packaging which allows for a compact PC board layout.

### FEATURES

- Enhanced sensitivity
- Latching magnetics respond to alternating North and South poles
- Wide operating voltage range of 4 Vdc to 24 Vdc
- Built-in reverse voltage capability enhances the protection of the sensor and the circuits with which it is used
- Robust design: will operate up to 125 °C [257 °F]
- RoHS-compliant materials meet Directive 2002/95/EC

### POTENTIAL APPLICATIONS

#### Transportation

- Speed and RPM sensing
- Tachometer, counter pickup
- Motor and fan control
- Electronic window lift
- Convertible roof position

#### Industrial

- Flow-rate sensing for appliances
- Speed and RPM sensing
- Tachometer, counter pickup
- Brushless dc motor commutation
- Motor and fan control
- Robotics control

### PORTFOLIO

The SS361CT and SS461C are part of Honeywell's family of Latching Digital Hall-effect Sensor ICs, including:

- [SS360PT, SS460P, SS460P-T2](#)
- [SS360NT, SS360ST, SS360ST-10K SS460S, SS460S-T2](#)
- [SS361RT, SS461R](#)
- [SS46](#)
- [SS461A, SS466A](#)

# High Sensitivity Latching Digital Hall-effect Sensor ICs: SS361CT, SS461C

**Table 1. Electrical and Environmental Specifications**

(At  $V_s = 4.0$  Vdc to 24.0 Vdc, 20 mA load,  $T_A = -40$  °C to 125 °C [-40 °F to 257 °F] except where otherwise specified.)

Characteristic	Condition	Min.	Typ.	Max.	Unit
Supply voltage	—	4.0	—	24.0	Vdc
Supply current	$V_{supply} = 5$ Vdc at 25 °C [77 °F] —	— —	— —	6.0 8.0	mA
Output current	—	—	—	20.0	mA
$V_{sat}$	Gauss > 95	—	—	0.4	V
Output leakage current	Gauss < -95	—	—	10.0	μA
Rise/fall time	25 °C [77 °F]	—	—	1.5	μs
Thermal resistance	single layer, single sided PCB	—	303	—	°C/W
Magnetic characteristics:					
Operate (Bop)	-40 °C to 85 °C [-40 °F to 185 °F]	5	50	80	Gauss
Operate (Bop)	—	-5	50	95	
Release (Brp)	-40 °C to 85 °C [-40 °F to 185 °F]	-80	-50	-5	
Release (Brp)	—	-95	-50	-5	
Differential	-40 °C to 85 °C [-40 °F to 185 °F]	50	100	160	
Differential	—	50	100	190	
Operating temperature	—	-40 [-40]	—	125 [257]	°C [°F]
Storage temperature	—	-40 [-40]	—	150 [302]	°C [°F]
Soldering temperature and time: SS361CT SS461C	infrared reflow process: 245 °C [473 °F] for 10 s max. wave soldering process: 250 °C to 260 °C [482 °F to 500 °F] for 3 s max.				

## NOTICE

These Hall-effect sensor ICs may have an initial output in either the ON or OFF state if powered up with an applied magnetic field in the differential zone (applied magnetic field >Brp and <Bop). Honeywell recommends allowing 10 μs after supply voltage has reached 5 V (SS361CT) or 3 V (SS461C) for the output voltage to stabilize.

## NOTICE

The magnetic field strength (Gauss) required to cause the switch to change state (operate and release) will be as specified in the magnetic characteristics. To test the switch against the specified limits, the switch must be placed in a uniform magnetic field.

**CAUTION**  
ELECTROSTATIC  
SENSITIVE  
DEVICES

DO NOT OPEN OR HANDLE  
EXCEPT AT A  
STATIC FREE WORKSTATION

**ESD SENSITIVITY:  
CLASS 1C**

**Table 2. Absolute Maximum Specifications**

Characteristic	Min.	Typ.	Max.	Unit
Supply voltage	-28.0	—	28.0	V
Applied output voltage	-0.5	—	28.0	V
Output current	—	—	20.0	mA
Magnetic flux	—	—	no limit	Gauss

## NOTICE

Absolute maximum ratings are the extreme limits the device will momentarily withstand without damage to the device. Electrical and mechanical characteristics are not guaranteed if the specified voltage and/or currents are exceeded, nor will the device necessarily operate at absolute maximum ratings.

# High Sensitivity Latching Digital Hall-effect Sensor ICs: SS361CT, SS461C

Figure 1. Typical Magnetic Characteristics vs Ambient Temperature at Supply Voltage

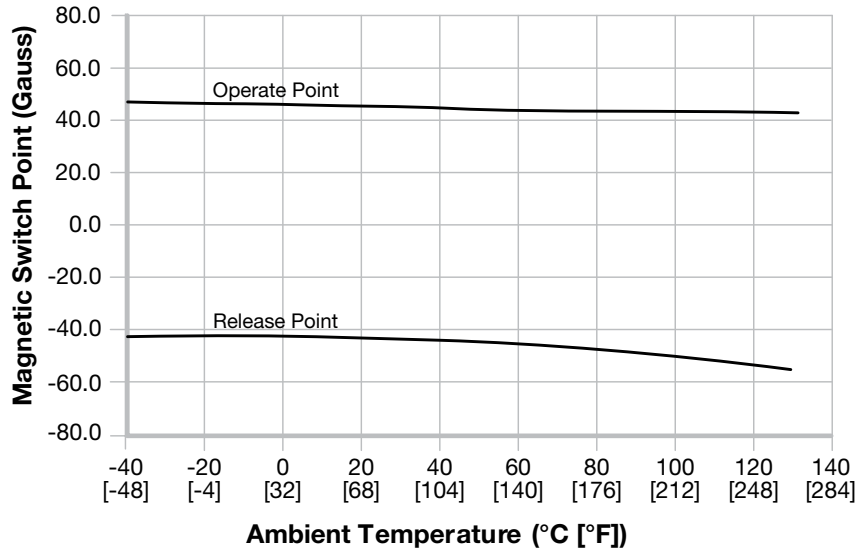

Figure 2. Current Sinking Output Block Diagram

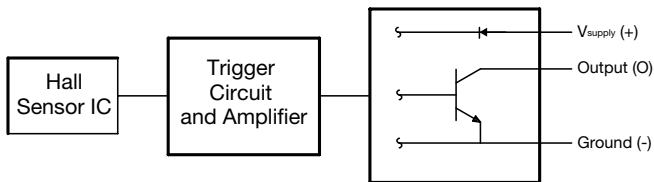

Figure 3. SS361CT Rated Supply Voltage

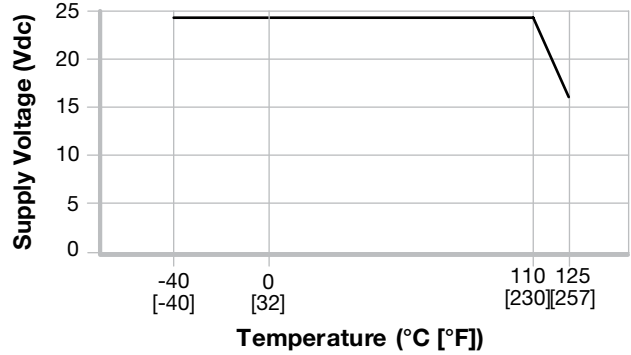

Figure 4. Magnetic Activation





# High Sensitivity Latching Digital Hall-effect Sensor ICs: SS361CT, SS461C

Figure 6. SS461C Sensor IC Mounting Dimensions (For reference only. mm/in.)

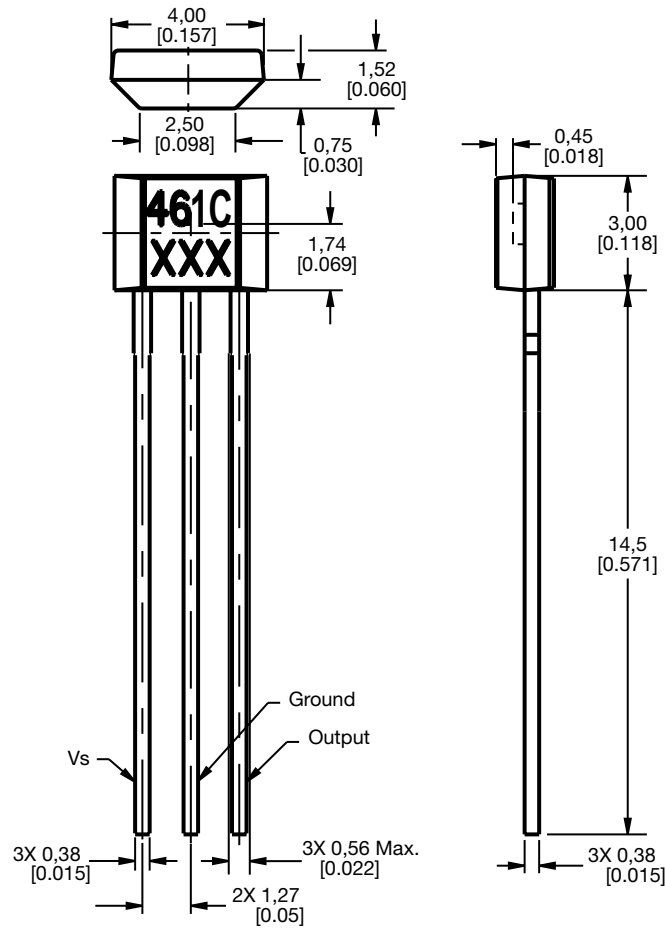



Table 3. Order Guide

Catalog Listing	Description	
SS361CT	High sensitivity latching, digital Hall-effect sensor IC, North pole activated, SOT-23 package, pocket tape and 178 mm [7 in] reel packaging (3000 units per reel)	
SS461C	High sensitivity latching, digital Hall-effect sensor IC, South pole activated, flat TO-92-style package, straight leads, bulk packaging (1000 units per bag)	

## ADDITIONAL INFORMATION

The following associated literature is available on the Honeywell web site at [sensing.honeywell.com](http://sensing.honeywell.com):

- Product Range Guide
- Product Line Guide
- Product Installation Instructions
- Technical Information

### **⚠ WARNING** **PERSONAL INJURY**

DO NOT USE these products as safety or emergency stop devices or in any other application where failure of the product could result in personal injury.

**Failure to comply with these instructions could result in death or serious injury.**

### **⚠ WARNING** **MISUSE OF DOCUMENTATION**

- The information presented in this datasheet is for reference only. Do not use this document as a product installation guide.
- Complete installation, operation, and maintenance information is provided in the instructions supplied with each product.

**Failure to comply with these instructions could result in death or serious injury.**

## Find out more

Honeywell serves its customers through a worldwide network of sales offices, representatives and distributors.

For application assistance, current specifications, pricing or name of the nearest Authorized Distributor, contact your local sales office.

To learn more about Honeywell Sensing and Productivity Solutions' products, call **+1-815-235-6847** or **1-800-537-6945**, visit **[sensing.honeywell.com](http://sensing.honeywell.com)**, or e-mail inquiries to **[info.sc@honeywell.com](mailto:info.sc@honeywell.com)**

Sensing and Productivity Solutions  
1985 Douglas Drive North  
Golden Valley, MN 55422  
**[honeywell.com](http://honeywell.com)**

## Warranty/Remedy

Honeywell warrants goods of its manufacture as being free of defective materials and faulty workmanship. Honeywell's standard product warranty applies unless agreed to otherwise by Honeywell in writing; please refer to your order acknowledgement or consult your local sales office for specific warranty details. If warranted goods are returned to Honeywell during the period of coverage, Honeywell will repair or replace, at its option, without charge those items it finds defective.

**The foregoing is buyer's sole remedy and is in lieu of all other warranties, expressed or implied, including those of merchantability and fitness for a particular purpose. In no event shall Honeywell be liable for consequential, special, or indirect damages.**

While we provide application assistance personally, through our literature and the Honeywell web site, it is up to the customer to determine the suitability of the product in the application.

Specifications may change without notice. The information we supply is believed to be accurate and reliable as of this printing. However, we assume no responsibility for its use.

# Honeywell

32309592-A-EN IL50  
September 2015  
© 2015 Honeywell International Inc. All rights reserved.

单击下面可查看定价，库存，交付和生命周期等信息

[>>Honeywell\(霍尼韦尔\)](#)