

ZG05HV Series

# High-Voltage Wire-to-Board Connector : Size: 0.5, Pitch: 3.3mm



Finger Protect



High Temp



Contact Reliability

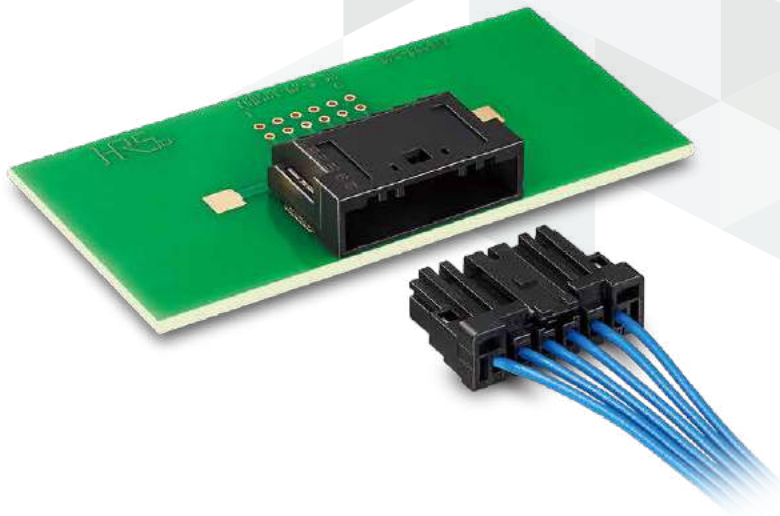

## Features

### 1. Supports High-Voltage

Rated Voltage : 1,000V AC/DC  
Withstanding Voltage : 3,000V AC

Housing Design ensures sufficient creepage and spatial distance between contacts, allowing for high rated and withstanding voltages in a compact form.

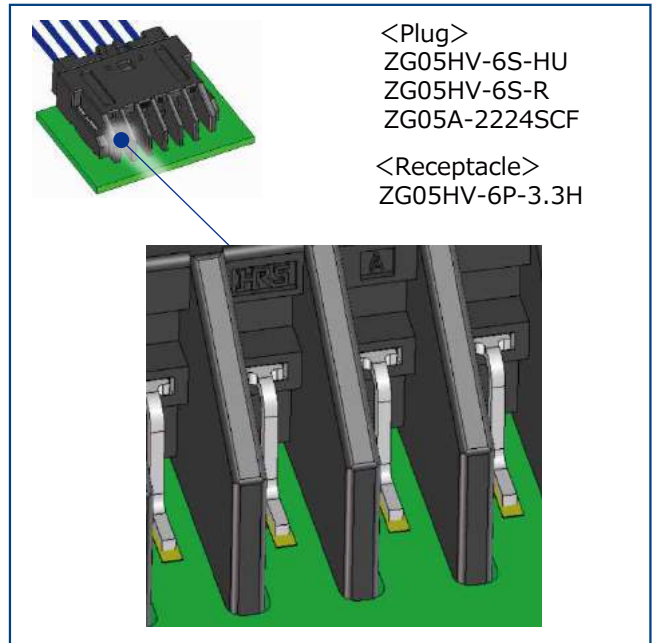

### 2. Electric Shock Prevention Design

The depth of the design provides electric shock protection, thereby enhancing assembly safety.

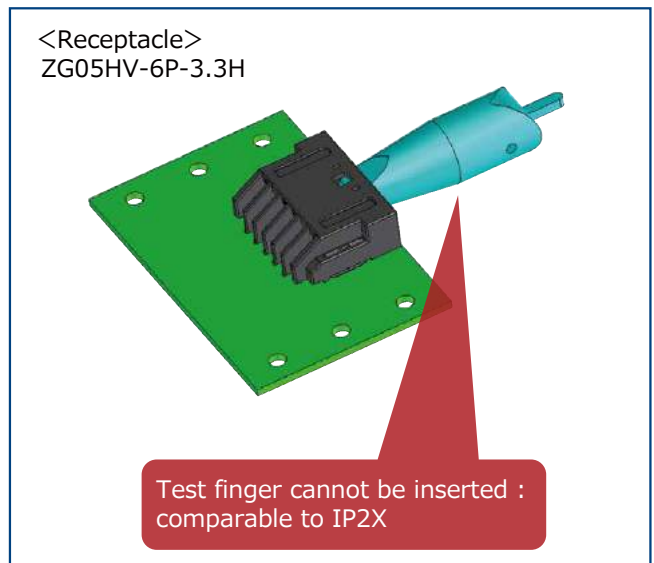

### 3. High Heat Resistance up to 125°C

- Can withstand temperatures up to 125 degrees, suitable for automotive and other high-heat applications.

Note: Temperature ratings include the rise due to current flow.

## 4. High Vibration Resistance

- Female contact features an innovative three-point contact design.
- Double-layered spring enhances stability
- Designed to maintain contact under intense vibrations, improving reliability.

### ① Double-Layered Spring Design

Provides superior vibration resistance and contact reliability.

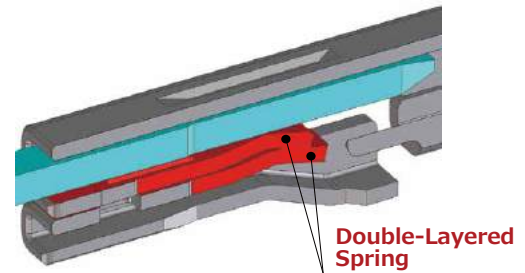

### ② 3-Point Contact Design

Withstands severe vibration due to improved contact reliability.  
1 Spring + 2 Embossed Contact Points = 3-Point Contact Design

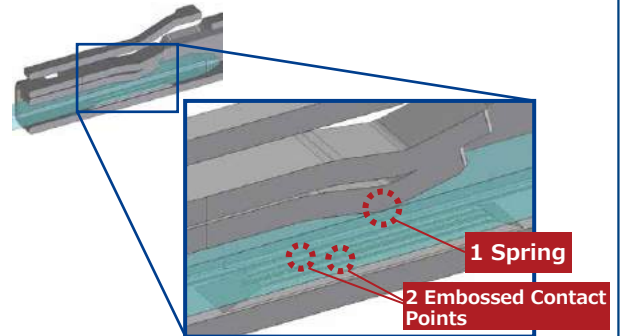

Note: The contact is intentionally inverted to make the embossed contact points more visible.

## 5. Mating Key Design Prevents Incorrect Insertion.

Prevents incorrect insertion, ensuring proper alignment.

- Mating Keys : Standard (Black) and A (Orange), Two Key Types

## Product Specifications

Rated Current	1A (All pins power supply)	Operating Temperature (Note1)	-40 to +125°C
Rated Voltage	1,000V AC/DC	Storage Temperature (Note2)	-10 to +60°C
		Storage Humidity Range (Note2)	Relative humidity 85% Max. (No condensation)

Items	Specifications	Conditions
Contact Resistance	10m Ω Max.	Measured at 1A DC
Insulation Resistance	100M Ω Min.	Measured at 1,000V DC
Withstanding Voltage	No insulation breakdown	Before mated connector : 2,000V AC for 1 min. After mated connector : 3,000V AC for 1 min.
Mating Durability	Contact Resistance : 20m Ω Max.	30 Insertion/Extraction cycles
Vibration Resistance	No electrical discontinuity of 7 Ω Min., 1 μ s Min. Contact Resistance : 20m Ω Max.	20 to 200Hz (Constant Acceleration of 88m/s <sup>2</sup> ), 1 Cycle 3 min. (round trip), 3 hours in 3 directions
Lock Strength	100N Min.	Lock breaking strength measured when pulling in mating axis direction
Humidity Resistance	Contact Resistance : 20m Ω Max. Insulation Resistance : 100M Ω Min.	Left for 96 hours at a temperature of 60°C and a relative humidity 90 to 95%
Thermal Shock	Contact Resistance : 20m Ω Max.	Temperature : -40°C → Room temperature → +125°C → Room temperature Time : 30 → 5 → 30 → 5 minutes for 1,000 cycles
Heat Resistance	Contact Resistance : 20m Ω Max.	Left at 140°C for 120 hours
Cold Resistance	Contact Resistance : 20m Ω Max.	Left at -40°C for 120 hours
Sulfuric Acid Gas Resistance	Contact Resistance : 20m Ω Max.	Left in sulfuric acid gas at room temperature with a concentration of 25ppm and 75% or more RH for 96 hours while unmated

Note 1 : Includes the temperature rise due to current flow.

Note 2 : Storage refers to long-term storage of unused items before they are mounted on the PCB.

The specified operating temperature and humidity apply when the product is unpowered post-PCB installation and during temporary storage in transit.

## Materials / Finish

Component	Part	Material	Color / Finish	UL Standard
Receptacle	Housing	PA	Black or Orange	UL94V-0
	Contact	Brass	Tin Plating (Nickle Underplating)	-
	Retention Tab	Brass	Tin Plating (Nickle Underplating)	-
Plug	Housing	PA	Black or Orange	UL94V-0
	Retainer	PA	Dark Gray	UL94V-0
Crimp Contact	Contact	Copper Alloy	Tin Plating (Copper Underplating)	-

## Product Number Structure

Please utilize the below part number chart when selecting.

### ■ Connector

**ZG05HV - 6 P - 3.3 H (A)**

①                      ② ③                      ④                      ⑤                      ⑥

### ■ Crimp Contact

**ZG05A - 2224 SCF**

⑦                      ⑧                      ⑨

① Series Name	ZG05HV	⑥ Mating Key	None : Standard (A) : A key
② No. of Pos.	Mass Production : 6pos. Under Planning : 10pos.	⑦ Contact Name	ZG05A
③ Connector Type	P : Receptacle S : Plug	⑧ Applicable Cable	22, 24 AWG
④ Contact Pitch	3.3mm	⑨ Type / Packaging Type	Socket Contact / Reel
⑤ Product Type	H : Horizontal Mounting Type HU : Socket Housing R : Retainer		

## Receptacle

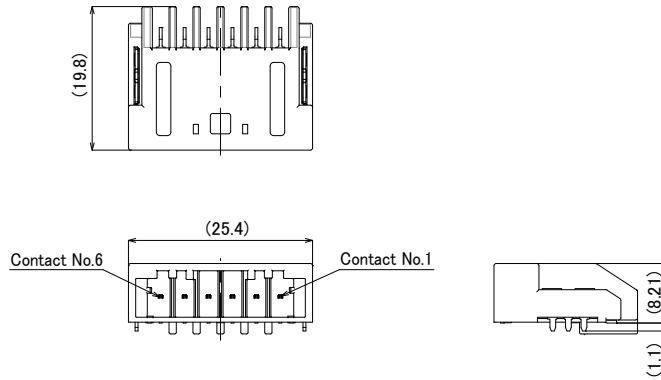

Part No.	HRS No.	Color	Mating Key	No. of Pos.	Purchase Unit
ZG05HV-6P-3.3H	CL0754-2112-0-00	Black	Standard	6	300pcs per reel
ZG05HV-6P-3.3H(A)	CL0754-2113-0-00	Orange	A Key	6	

## Plug Housing

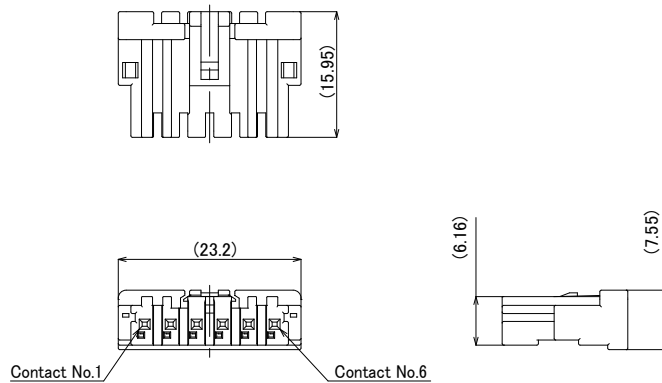

Part No.	HRS No.	Color	Mating Key	No. of Pos.	Purchase Unit
ZG05HV-6S-HU	CL0754-2206-0-00	Black	Standard	6	1,000pcs per box
ZG05HV-6S-HU(A)	CL0754-2207-0-00	Orange	A Key	6	

Note : Use with the retainer (ZG05HV-6S-R), sold separately.

## Retainer

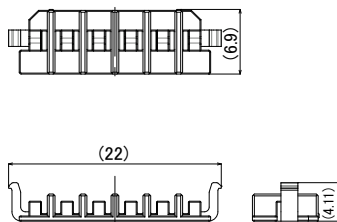

Part No.	HRS No.	No. of Pos.	Purchase Unit
ZG05HV-6S-R	CL0754-2300-0-00	6	6,000pcs per box

Note : Attach to the plug housing (ZG05HV-6S-HU(#)), sold separately.

## Crimp Contact

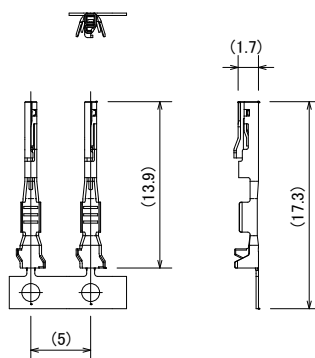

Part No.	HRS No.	Applicable Cable	Purchase Unit
ZG05A-2224SCF	CL0754-2001-0-00	22, 24 AWG (0.22-0.35sq), Jacket Outer Diameter $\phi$ 1.1-1.4mm	15,000pcs per reel

## Applicable Tools

Type	Part No.	HRS No.	Compatible Crimp Contact
Hirose Crimping Tool	CM-105C	CL0901-0001-0-00	-
Applicator for Hirose Crimping Tool	AP105-ZG05A-2224S	CL0901-5240-0-00	ZG05A-2224SCF
Japan Automatic Machine Applicator (Note 1)	CHX0346000H	-	ZG05A-2224SCF
Hand Tool (Note 2)	HT802/ZG05A-2224S (Note 3)	CL0550-0313-0-00	ZG05A-2224SCF
Retainer Releasing Tool	ZG05HV/R/RE-MD	CL0902-5176-0-00	-
Contact Removing Tool	ZG05A/RE-MD	CL0902-5146-0-00	-

Note 1 : Contact Japan Automatic Machine (J.A.M.) regarding crimping failure relating to applicable J.A.M. applicators or for other applicator inquiries via the J.A.M. website. (URL : <http://www.jam-net.co.jp>)

Note 2 : Hand tools are developed as a prototype tool during product development. Use an applicator for mass production.

Note 3 : Applicable cables are limited to 0.22 and 0.35sq. Cut the reel contact for use with the hand tool.

Note 4 : Crimping should be carried out based on the "Crimping Quality Standards" and "Crimping Conditions Table."

Note 5 : Problems caused by tools other than those specified are not covered by the warranty.

## Usage Precautions

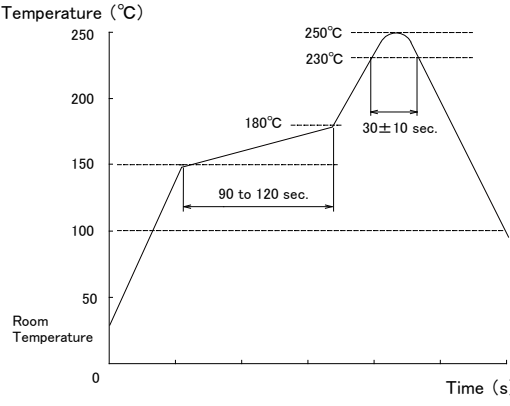
<p>Recommended Temperature Profile</p>	 <p><b>Temperature (°C)</b></p> <p>250 200 150 100 50 Room Temperature 0</p> <p>180°C 250°C 230°C 30 ± 10 sec. 90 to 120 sec. Time (s)</p> <p><b>【Conditions】</b></p> <ol style="list-style-type: none"> <li>1. Reflow Heating Method Used : Far infrared, air atmosphere or nitrogen</li> <li>2. Peak Temperature 250°C Peak</li> <li>3. Heated part 230°C Min. 20-40 sec.</li> <li>4. Preheat Temperature 150 to 180°C 90-120 sec.</li> <li>5. Cycles 2 times Max.</li> </ol>
<p>Recommended Manual Soldering Conditions</p>	<p>Soldering iron temperature : 280 to 300°C , Soldering time : within 2 seconds</p>
<p>Cautions</p>	<ol style="list-style-type: none"> <li>1. Forcing the connector out may result in damage. If difficult to remove, gently press down once before releasing the lock.</li> <li>2. Always disconnect power before reseating the connector.</li> <li>3. Avoid touching the terminal area when the power is active, as it's hazardous.</li> <li>4. For harnessing guidelines, please consult a Hirose representative.</li> </ol>

## While Taking into Consideration

Specifications mentioned in this catalog are reference values.

When considering to order or use this product, please review the Drawing and Product Specifications sheets.

Use an appropriate cable when using the connector in combination with cables.

If considering usage of a non-specified cable, please contact your sales representative.

If assembly process is done by jigs & tools which are not identified by Hirose, the warranty of the product may be affected.

If considering usage for below mentioned applications, please contact your sales representative.

In cases where the application will demand a high level of reliability, such as automotive, medical instruments, public infrastructure, aerospace/defense etc. Hirose must review before assurance of reliability can be given.

HIROSE

**HRS HIROSE ELECTRIC CO.,LTD.**

2-6-3 Nakagawa Chuoh, Tsuzuki-Ku, Yokohama-Shi 224-8540, JAPAN  
<https://www.hirose.com>



单击下面可查看定价，库存，交付和生命周期等信息

[>>HRS\(广濂\)](#)