

## FEATURES

- Wide range of supply voltages
- Low supply current drain independent of supply voltage
- Low input biasing current
- Low input offset current
- Low input offset voltage
- Input common-mode voltage range includes GND
- Differential input voltage range equal to the power supply voltage
- DC voltage gain 100V/mV Typ.
- Internally frequency compensation

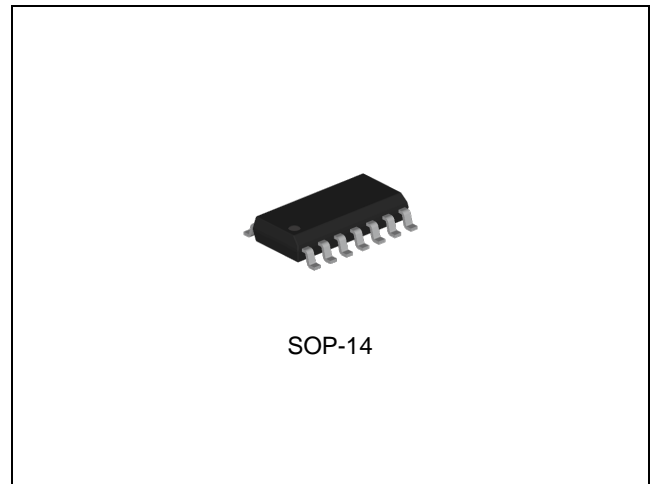

## DESCRIPTION

The TJ324 consists of four independent, high gain, internally frequency compensated operational amplifiers which were designed specifically to operate from a single power supply over a wide range of voltages. Operation from split power supplies is also possible and the low power supply current drain is independent of the magnitude of the power supply voltage.

Application areas include transducer amplifiers, DC gain blocks and all the conventional op amp circuits.

## ORDERING INFORMATION

Device	Package
TJ324GD	SOP-14

## ABSOLUTE MAXIMUM RATINGS (Note 1)

CHARACTERISTIC	SYMBOL	MIN.	MAX.	UNIT
Supply Voltage	$V_{CC}$	-	36 or $\pm 18$	V
Differential Input Voltage	$V_{ID}$	-	36	V
Input Voltage Range (either input)	$V_{IC}$	-0.3	36	V
Output Voltage	$V_O$	-	36	V
Maximum Junction Temperature	$T_J$	-	150	$^{\circ}C$
Operating Ambient Temperature Range	$T_A$	-40	125	$^{\circ}C$
Storage Temperature Range	$T_{STG}$	-65	150	$^{\circ}C$

Note 1. Stresses beyond those listed under *Absolute Maximum Ratings* may cause permanent damage to the device. These are stress ratings only and functional operation of the device at these or any other conditions beyond those indicated under *Recommended Operating Conditions* is not implied. Exposure to absolute-maximum-rated conditions for extended periods may affect device reliability.

## RECOMMENDED OPERATING CONDITIONS (Note 2)

CHARACTERISTIC	SYMBOL	MIN.	MAX.	UNIT
Supply Voltage	$V_{CC}$	2.0	30	V
Maximum Junction Temperature	$T_J$	-	125	°C
Operating Ambient Temperature Range	$T_{OPR}$	-40	105	°C

Note 2. The device is not guaranteed to function outside its operating ratings.

## ORDERING INFORMATION

Package	Order No.	Description	Supplied As	Status
SOP-14	TJ324GD	Quad Operational Amplifiers	Tape & Reel	Active

## PIN CONFIGURATION

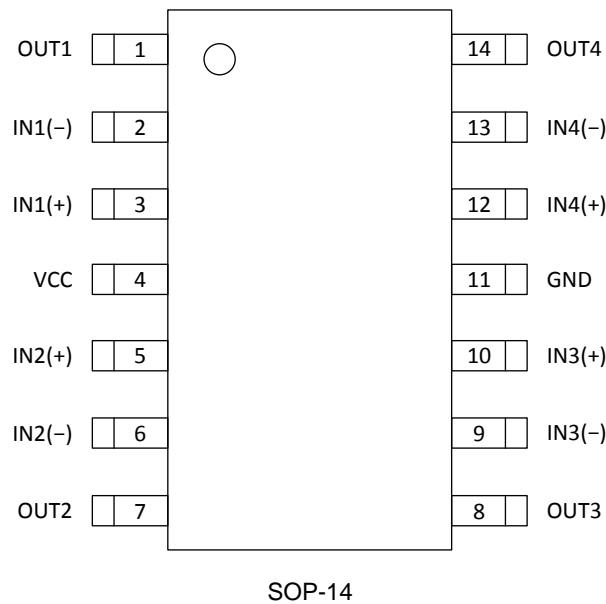

## PIN DESCRIPTION

Pin No.	Pin Name	Pin Function
1	OUT1	Output of the Amplifier 1
2	IN1(-)	Inverting Input of the Amplifier 1
3	IN1(+)	Non-inverting Input of the Amplifier 1
4	VCC	Positive Power Supply (V+)
5	IN2(+)	Non-inverting Input of the Amplifier 2
6	IN2(-)	Inverting Input of the Amplifier 2
7	OUT2	Output of the Amplifier 2
8	OUT3	Output of the Amplifier 3
9	IN3(-)	Inverting Input of the Amplifier 3
10	IN3(+)	Non-inverting Input of the Amplifier 3
11	GND	Ground or Negative Supply
12	IN4(+)	Non-inverting Input of the Amplifier 4
13	IN4(-)	Inverting Input of the Amplifier 4
14	OUT4	Output of the Amplifier 4

## ELECTRICAL CHARACTERISTICS

At specified free-air temperature,  $V_{CC} = 5V$ , unless otherwise specified

SYMBOL	PARAMETER	TEST CONDITIONS	$T_A$	MIN	TYP	MAX	UNIT
$V_{IO}$	Input Offset Voltage	$V_{CC} = 5V$ to MAX, $V_{IC} = V_{ICR}$ min, $V_O = 1.4V$	25°C	-	3	7	mV
			Full range	-	-	9	
$\alpha V_{IO}$	Average Temperature Coefficient of $V_{IO}$		Full range	-	7	-	$\mu V/^\circ C$
$I_{IO}$	Input Offset Current	$V_O = 1.4V$	25°C	-	2	50	nA
			Full range	-	-	150	
$\alpha I_{IO}$	Average Temperature Coefficient of $I_{IO}$		Full range	-	10	-	$\mu A/^\circ C$
$I_{IB}$	Input Bias Current	$V_O = 1.4V$	25°C	-	-20	-250	nA
			Full range	-	-	-500	
$V_{ICR}$	Common-mode Input Voltage Range	$V_{CC} = 5V$ to MAX	25°C	0	-	$V_{CC}-1.5$	V
			Full range	0	-	$V_{CC}-2.0$	
$V_{OH}$	High-Level Output Voltage	$R_L = 2k\Omega$	25°C	$V_{CC}-1.5$	-	-	V
		$V_{CC} = MAX$ , $R_L = 2k\Omega$	Full range	26	-	-	
		$V_{CC} = MAX$ , $R_L = 10k\Omega$	Full range	27	28	-	
$V_{OL}$	Low-Level Output Voltage	$R_L = 10k\Omega$	Full range	-	5	20	mV
$A_{VD}$	Large-Signal Differential Voltage Amplification	$V_{CC} = 15V$ , $V_O = 1V$ to 11V, $R_L \geq 2k\Omega$	25°C	25	100	-	V/mV
			Full range	15	-	-	
CMRR	Common-mode Rejection Ratio	$V_{CC} = 5V$ to MAX, $V_{IC} = V_{ICR}$ min	25°C	65	80	-	dB
PSRR	Supply Voltage Rejection Ratio ( $\Delta V_{CC}/\Delta V_{IO}$ )	$V_{CC} = 5V$ to MAX	25°C	65	100	-	dB
$V_{O1}/V_{O2}$	Crosstalk Attenuation	$f = 1kHz$ to 20kHz	25°C	-	120	-	dB
$I_{O+}$	Output Source Current	$V_{CC} = 15V$ , $V_{ID} = 1V$ , $V_O = 0V$	25°C	-20	-30	-	mA
			Full range	-10	-	-	
$I_{O-}$	Output Sink Current	$V_{CC} = 15V$ , $V_{ID} = -1V$ , $V_O = 15V$	25°C	10	20	-	mA
			Full range	5	-	-	
		$V_{ID} = -1V$ , $V_O = 200mV$	25°C	12	30	-	$\mu A$
$I_{SC}$	Output Short-Circuit Current	$V_{CC} = 5V$ , GND = -5V, $V_O = 0V$	25°C	-	$\pm 40$	$\pm 60$	mA
$I_{CC}$	Supply Current	$V_O = 2.5V$ , No Load	Full range	-	1.1	2.4	mA
		$V_{CC} = MAX$ , $V_O = 0.5V_{CC}$ , No Load	Full range	-	1.5	3	

Note 3. Temperature full range is  $-40^\circ C$  to  $+105^\circ C$ .  $V_{CC}$  MAX for testing purpose is 30V.

Note 4. All characteristics are measured under open loop conditions with zero common-mode input voltage unless otherwise specified.

## TYPICAL OPERATING CHARACTERISTICS

SUPPLY CURRENT

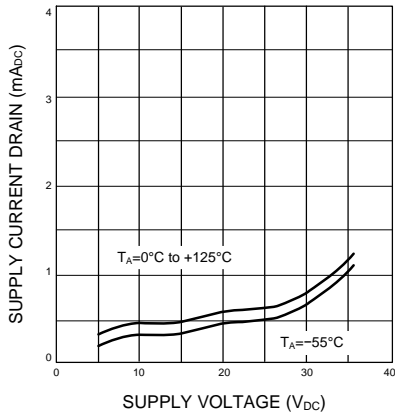

OUTPUT CHARACTERISTICS  
CURRENT SOURCING

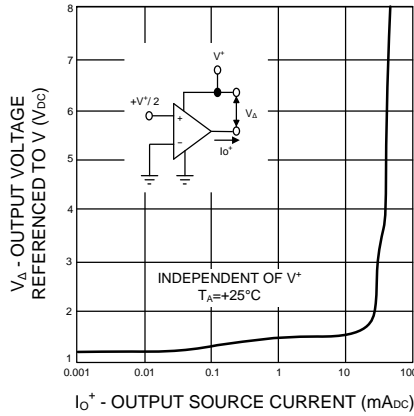

CURRENT LIMITING

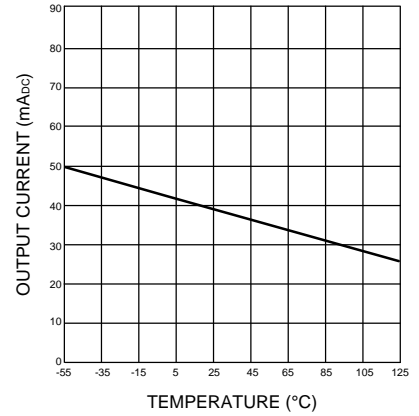

VOLTAGE GAIN

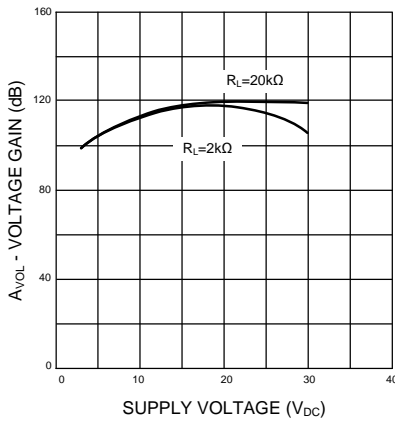

OUTPUT CHARACTERISTICS  
CURRENT SINKING

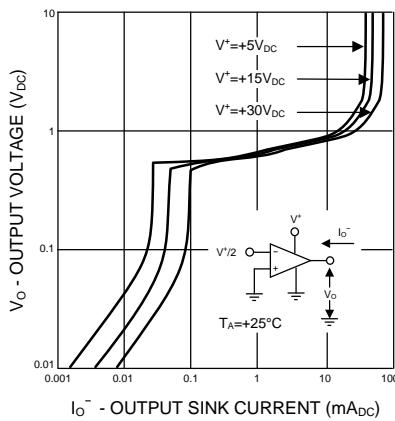

OPEN-LOOP FREQUENCY RESPONSE

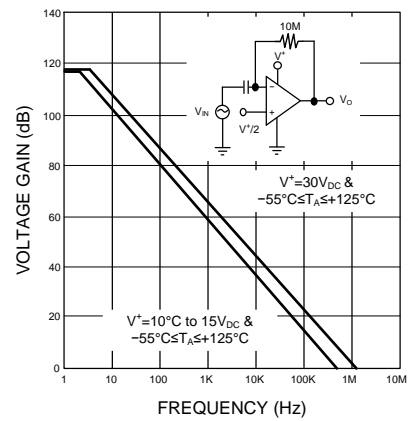

LARGE-SIGNAL FREQUENCY RESPONSE

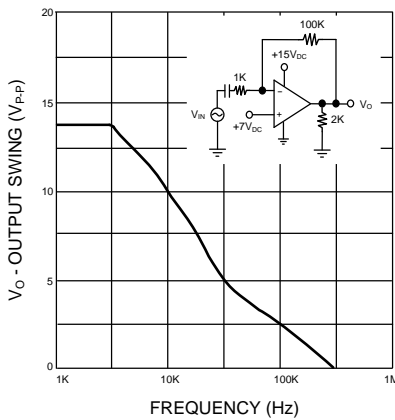

VOLTAGE-FOLLOWER PULSE RESPONSE

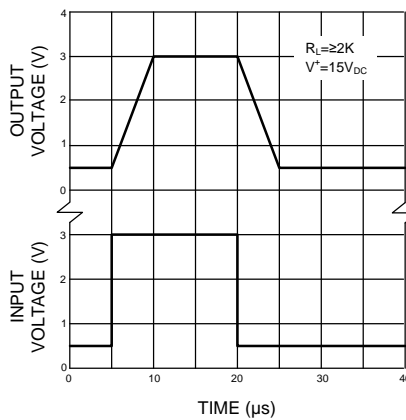

INPUT VOLTAGE RANGE

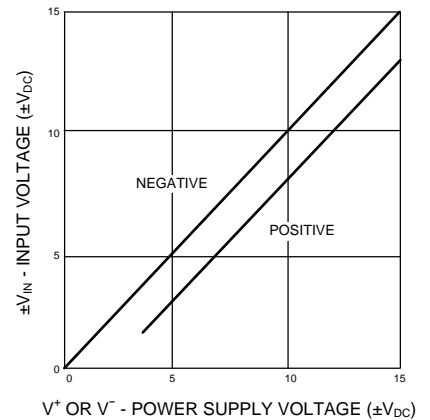

## TYPICAL OPERATING CHARACTERISTICS (continued)

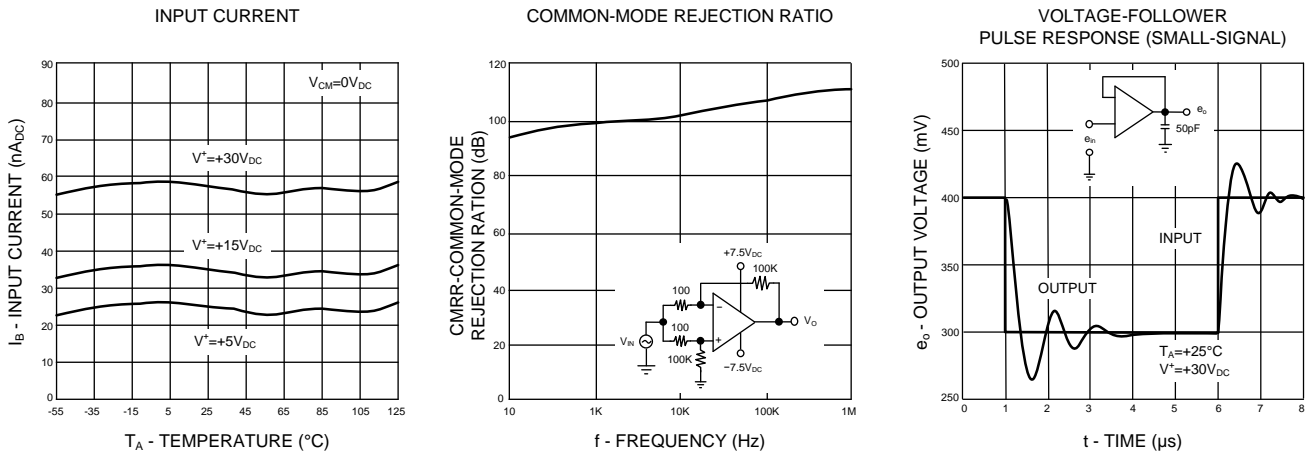

## TYPICAL APPLICATION CIRCUITS

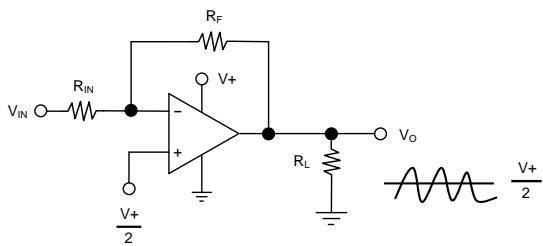

SINGLE SUPPLY INVERTING AMPLIFIER

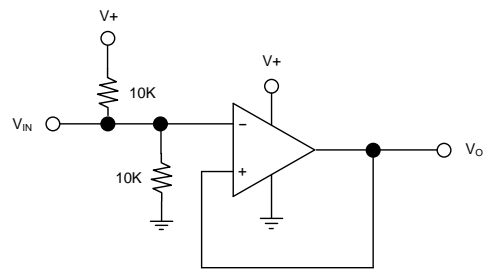

INPUT BIASING VOLTAGE FOLLOWER

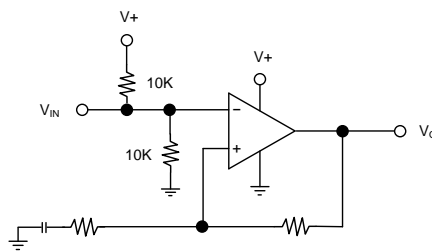

NON-INVERTING AMPLIFIER

## REVISION NOTICE

The description in this datasheet is subject to change without any notice to describe its electrical characteristics properly.

单击下面可查看定价，库存，交付和生命周期等信息

[>>HTC\(泰进\)](#)