

## FEATURES

- Output Current Up to 100mA
- No External Components
- Internal Thermal Overload Protection
- Internal Short-Circuit Limiting
- Output Voltage of -5V, -6V, -8V, -9V, -12V, -15V, -18V, and -24V
- Moisture Sensitivity Level 3

## DESCRIPTION

This series of fixed-voltage monolithic integrated-circuit voltage regulators is designed for a wide range of applications. These applications include on-card regulation for elimination of noise and distribution problems associated with single-point regulation. In addition, they can be used with power-pass elements to make high current voltage regulators.

Each of these regulators can deliver up to 100mA of output current. The internal limiting and thermal shutdown features of these regulators make them essentially immune to overload. When used as a replacement for a zener diode-resistor combination, an effective improvement in output impedance can be obtained together with lower-bias current.

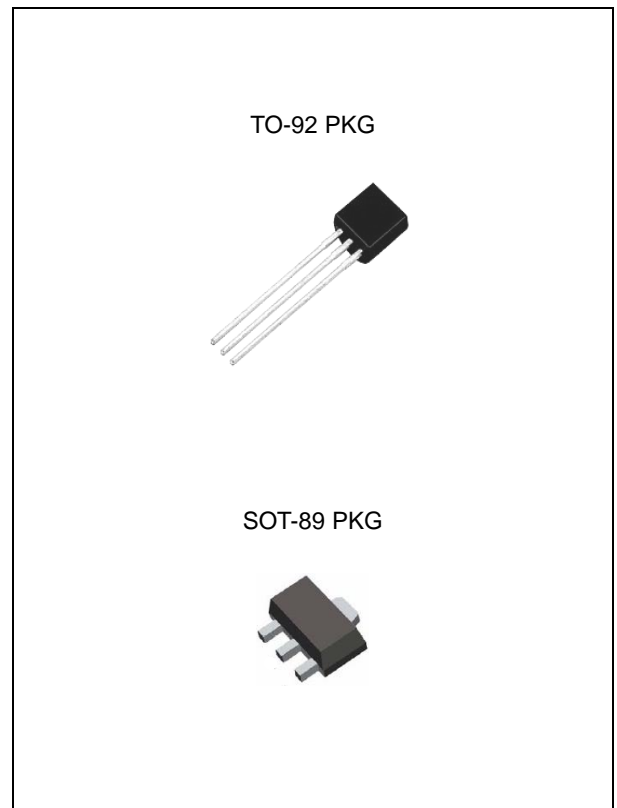

## ORDERING INFORMATION

Device	Package
LM79Lxx	TO-92 (Bulk)
LM79LxxTA	TO-92 (Taping)
LM79LxxF	SOT-89

xx: Output Voltage

## ABSOLUTE MAXIMUM RATINGS

CHARACTERISTIC		SYMBOL	MIN.	MAX.	UNIT
Input Voltage	LM79L05 ~ LM79L09	$V_{IN}$	-	-30	V
	LM79L12 ~ LM79L18		-	-35	
	LM79L24		-	-40	
Maximum Power Dissipation at $T_A = 25^\circ\text{C}$ / TO-92		$P_{DMax}$	-	0.770	W
Thermal Resistance Junction-To-Ambient / TO-92		$\theta_{JA}$	-	162	$^\circ\text{C}/\text{W}$
Lead Temperature (Soldering, 10 sec)		$T_{SOL}$	-	260	$^\circ\text{C}$
Storage Temperature Range		$T_{STG}$	-65	150	$^\circ\text{C}$
Operating Junction Temperature Range		$T_{JOPR}$	-40	125	$^\circ\text{C}$

## RECOMMENDED OPERATING RATINGS

CHARACTERISTIC		SYMBOL	MIN.	MAX.	UNIT
Input Voltage	LM79L05	$V_{IN}$	-7	-20	V
	LM79L06		-8	-20	
	LM79L08		-10.5	-23	
	LM79L09		-11.5	-24	
	LM79L12		-14.5	-27	
	LM79L15		-17.5	-30	
	LM79L18		-20.5	-33	
	LM79L24		-27	-38	
Output Current		$I_o$	-	100	mA
Operating Junction Temperature		$T_J$	-40	125	°C

## ORDERING INFORMATION

VOUT	Package	Order No.	Description	Supplied As	Status
-5.0V	TO-92	LM79L05	0.1A, Negative	Bulk	Active
		LM79L05TA	0.1A, Negative	Taping	Active
	SOT-89	LM79L05F	0.1A, Negative	Reel	Active
-6.0V	TO-92	LM79L06	0.1A, Negative	Bulk	Active
		LM79L06TA	0.1A, Negative	Taping	Active
	SOT-89	LM79L06F	0.1A, Negative	Reel	Active
-8.0V	TO-92	LM79L08	0.1A, Negative	Bulk	Active
		LM79L08TA	0.1A, Negative	Taping	Active
	SOT-89	LM79L08F	0.1A, Negative	Reel	Active
-9.0V	TO-92	LM79L09	0.1A, Negative	Bulk	Active
		LM79L09TA	0.1A, Negative	Taping	Active
	SOT-89	LM79L09F	0.1A, Negative	Reel	Active
-12V	TO-92	LM79L12	0.1A, Negative	Bulk	Active
		LM79L12TA	0.1A, Negative	Taping	Active
	SOT-89	LM79L12F	0.1A, Negative	Reel	Active
-15V	TO-92	LM79L15	0.1A, Negative	Bulk	Active
		LM79L15TA	0.1A, Negative	Taping	Active
	SOT-89	LM79L15F	0.1A, Negative	Reel	Active

# 3-TERMINAL 0.1A NEGATIVE VOLTAGE REGULATOR

# LM79Lxx

## ORDERING INFORMATION (Continued)

VOUT	Package	Order No.	Description	Supplied As	Status
-18V	TO-92	LM79L18	0.1A, Negative	Bulk	Active
		LM79L18TA	0.1A, Negative	Taping	Active
	SOT-89	LM79L18F	0.1A, Negative	Reel	Active
-24V	TO-92	LM79L24	0.1A, Negative	Bulk	Active
		LM79L24TA	0.1A, Negative	Taping	Active
	SOT-89	LM79L24F	0.1A, Negative	Reel	Active

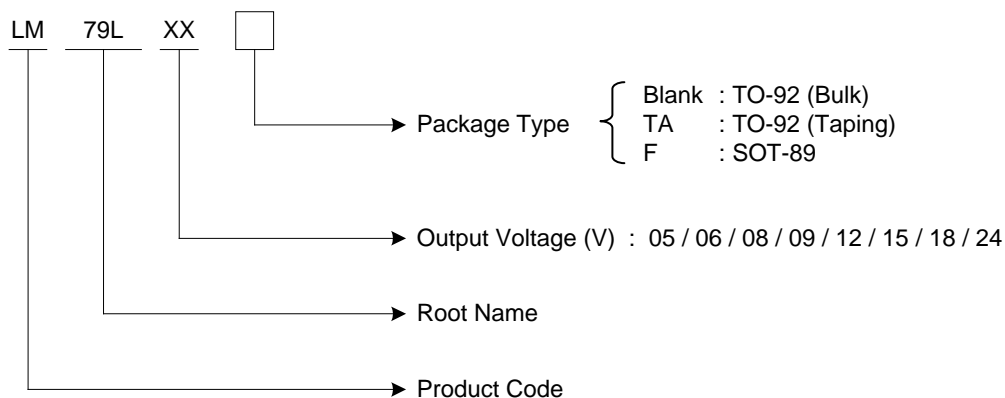

## PIN CONFIGURATION

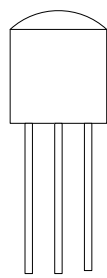

TO-92

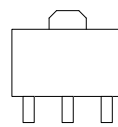

SOT-89

## PIN DESCRIPTION

Pin No.	TO-92 / SOT-89	
	Name	Function
1	GND	Ground
2	$V_{IN}$	Input Voltage
3	$V_{OUT}$	Output Voltage

## TYPICAL APPLICATION

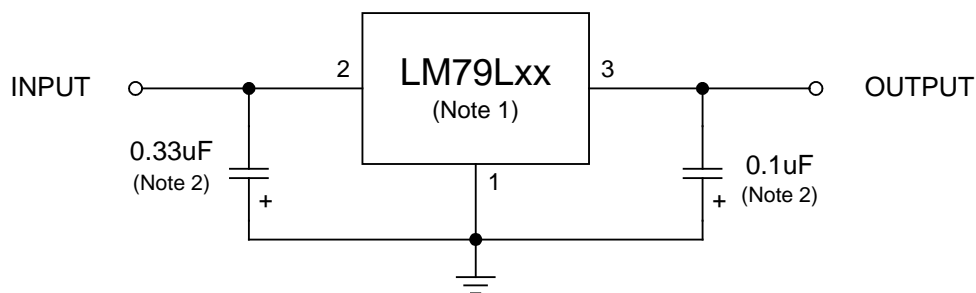

Note 1. To specify an output voltage, substitute voltage for "XX".

Note 2. Bypass capacitors are recommended for optimum stability and transient response and should be located as close as possible to the regulators.

## ELECTRICAL CHARACTERISTICS

**LM79L05** (At specified virtual junction temperature,  $V_{IN} = -10V$ ,  $I_o = 40mA$  (Unless otherwise noted))

PARAMETER	SYMBOL	TEST CONDITION <sup>(Note 1)</sup>		MIN.	TYP.	MAX.	UNIT
Output Voltage <sup>(Note 2)</sup>	$V_{OUT}$		25°C	-4.8	-5	-5.2	V
		$1mA \leq I_o \leq 40mA$ $-7V \leq V_{IN} \leq 20V$	-30°C ~ 125°C	-4.75	-5	-5.25	
		$1mA \leq I_o \leq 70mA$		-4.75	-5	-5.25	
Line Regulation	$\Delta V_{LINE}$	$-7V \leq V_{IN} \leq -20V$	25°C		32	150	mV
		$-8V \leq V_{IN} \leq -20V$			26	100	
Load Regulation	$\Delta V_{LOAD}$	$1mA \leq I_o \leq 100mA$	25°C		15	60	mV
		$1mA \leq I_o \leq 40mA$			8	30	
Bias Current	$I_B$		25°C		3.8	6	mA
			125°C			5.5	
Bias Current Change	$\Delta I_B$	$-8V \leq V_{IN} \leq -20V$	-30°C ~ 125°C			1.5	mA
		$1mA \leq I_o \leq 40mA$				0.1	
Output Noise Voltage	$V_N$	$10Hz \leq f \leq 100kHz$	25°C		42		uV
Ripple Rejection	RR	$-8V \leq V_{IN} \leq -18V$ , $f=120Hz$	25°C	41	49		dB
Dropout Voltage	$V_D$		25°C		1.7		V

**LM79L06** (At specified virtual junction temperature,  $V_{IN} = -11V$ ,  $I_o = 40mA$  (Unless otherwise noted))

PARAMETER	SYMBOL	TEST CONDITION <sup>(Note 1)</sup>		MIN.	TYP.	MAX.	UNIT
Output Voltage <sup>(Note 2)</sup>	$V_{OUT}$		25°C	-5.76	-6	-6.24	V
		$1mA \leq I_o \leq 40mA$ $-8V \leq V_{IN} \leq -21V$	-30°C ~ 125°C	-5.7	-6	-6.3	
		$1mA \leq I_o \leq 70mA$		-5.7	-6	-6.3	
Line Regulation	$\Delta V_{LINE}$	$-8V \leq V_{IN} \leq -21V$	25°C		50	150	mV
		$-9V \leq V_{IN} \leq -21V$			45	110	
Load Regulation	$\Delta V_{LOAD}$	$1mA \leq I_o \leq 100mA$	25°C		12	70	mV
		$1mA \leq I_o \leq 40mA$			5.5	35	
Bias Current	$I_B$		25°C			6	mA
			125°C			5.5	
Bias Current Change	$\Delta I_B$	$-9V \leq V_{IN} \leq -21V$	-30°C ~ 125°C			1.5	mA
		$1mA \leq I_o \leq 40mA$				0.1	
Output Noise Voltage	$V_N$	$10Hz \leq f \leq 100kHz$	25°C		50		uV
Ripple Rejection	RR	$-9V \leq V_{IN} \leq -19V$ , $f=120Hz$	25°C	39	47		dB
Dropout Voltage	$V_D$		25°C		1.7		V

### 3-TERMINAL 0.1A NEGATIVE VOLTAGE REGULATOR

### LM79Lxx

**LM79L08** (At specified virtual junction temperature,  $V_{IN} = -14V$ ,  $I_o = 40mA$  (Unless otherwise noted))

PARAMETER	SYMBOL	TEST CONDITION <sup>(Note 1)</sup>		MIN.	TYP.	MAX.	UNIT
Output Voltage <sup>(Note 2)</sup>	$V_{OUT}$		25°C	-7.7	-8	-8.3	V
		$1mA \leq I_o \leq 40mA$ $-10.5V \leq V_{IN} \leq -23V$	-30°C ~ 125°C	-7.6	-8	-8.4	
		$1mA \leq I_o \leq 70mA$		-7.6	-8	-8.4	
Line Regulation	$\Delta V_{LINE}$	$-10.5V \leq V_{IN} \leq -23V$	25°C		20	175	mV
		$-11V \leq V_{IN} \leq -23V$			12	125	
Load Regulation	$\Delta V_{LOAD}$	$1mA \leq I_o \leq 100mA$	25°C		18	80	mV
		$1mA \leq I_o \leq 40mA$			9	42	
Bias Current	$I_B$		25°C			6.5	mA
			125°C			6	
Bias Current Change	$\Delta I_B$	$-11V \leq V_{IN} \leq -23V$	-30°C ~ 125°C			1.5	mA
		$1mA \leq I_o \leq 40mA$				0.1	
Output Noise Voltage	$V_N$	$10Hz \leq f \leq 100kHz$	25°C		60		uV
Ripple Rejection	RR	$-12V \leq V_{IN} \leq -23V$ , $f=120Hz$	25°C	42	49		dB
Dropout Voltage	$V_D$		25°C		1.7		V

**LM79L09** (At specified virtual junction temperature,  $V_{IN} = -15V$ ,  $I_o = 40mA$  (Unless otherwise noted))

PARAMETER	SYMBOL	TEST CONDITION <sup>(Note 1)</sup>		MIN.	TYP.	MAX.	UNIT
Output Voltage <sup>(Note 2)</sup>	$V_{OUT}$		25°C	-8.64	-9	-9.36	V
		$1mA \leq I_o \leq 40mA$ $-11V \leq V_{IN} \leq -24V$	-30°C ~ 125°C	-8.55	9	-9.45	
		$1mA \leq I_o \leq 70mA$		-8.55	9	-9.45	
Line Regulation	$\Delta V_{LINE}$	$-11V \leq V_{IN} \leq -24V$	25°C		80	200	mV
		$-12V \leq V_{IN} \leq -24V$			20	160	
Load Regulation	$\Delta V_{LOAD}$	$1mA \leq I_o \leq 100mA$	25°C		17	90	mV
		$1mA \leq I_o \leq 40mA$			8	45	
Bias Current	$I_B$		25°C		3.8	6.5	mA
			125°C			6	
Bias Current Change	$\Delta I_B$	$-12V \leq V_{IN} \leq -24V$	-30°C ~ 125°C			1.5	mA
		$1mA \leq I_o \leq 40mA$				0.1	
Output Noise Voltage	$V_N$	$10Hz \leq f \leq 100kHz$	25°C		64		uV
Ripple Rejection	RR	$-8V \leq V_{IN} \leq -18V$ , $f=120Hz$	25°C	35	43		dB
Dropout Voltage	$V_D$		25°C		1.7		V

### 3-TERMINAL 0.1A NEGATIVE VOLTAGE REGULATOR

### LM79Lxx

**LM79L12** (At specified virtual junction temperature,  $V_{IN} = -19V$ ,  $I_o = 40mA$  (Unless otherwise noted))

PARAMETER	SYMBOL	TEST CONDITION <sup>(Note 1)</sup>		MIN.	TYP.	MAX.	UNIT
Output Voltage <sup>(Note 2)</sup>	$V_{OUT}$		25°C	-11.5	-12	-12.5	V
		$1mA \leq I_o \leq 40mA$ $-14.5V \leq V_{IN} \leq -27V$	-30°C ~ 125°C	-11.4	-12	-12.6	
		$1mA \leq I_o \leq 70mA$		-11.4	-12	-12.6	
Line Regulation	$\Delta V_{LINE}$	$-14.5V \leq V_{IN} \leq -27V$	25°C		50	250	mV
		$-16V \leq V_{IN} \leq -27V$			40	200	
Load Regulation	$\Delta V_{LOAD}$	$1mA \leq I_o \leq 100mA$	25°C		24	100	mV
		$1mA \leq I_o \leq 40mA$			15	50	
Bias Current	$I_B$		25°C			6.5	mA
			125°C			6	
Bias Current Change	$\Delta I_B$	$-16V \leq V_{IN} \leq -27V$	-30°C ~ 125°C			1.5	mA
		$1mA \leq I_o \leq 40mA$				0.1	
Output Noise Voltage	$V_N$	$10Hz \leq f \leq 100kHz$	25°C		70		uV
Ripple Rejection	RR	$-15V \leq V_{IN} \leq -25V$ , $f=120Hz$	25°C	37	42		dB
Dropout Voltage	$V_D$		25°C		1.7		V

**LM79L15** (At specified virtual junction temperature,  $V_{IN} = -23V$ ,  $I_o = 40mA$  (Unless otherwise noted))

PARAMETER	SYMBOL	TEST CONDITION <sup>(Note 1)</sup>		MIN.	TYP.	MAX.	UNIT
Output Voltage <sup>(Note 2)</sup>	$V_{OUT}$		25°C	-14.4	-15	-15.6	V
		$1mA \leq I_o \leq 40mA$ $-17.5V \leq V_{IN} \leq -30V$	-30°C ~ 125°C	-14.25	-15	-15.75	
		$1mA \leq I_o \leq 70mA$		-14.25	-15	-15.75	
Line Regulation	$\Delta V_{LINE}$	$-17.5V \leq V_{IN} \leq -30V$	25°C		65	300	mV
		$-27V \leq V_{IN} \leq -30V$			58	250	
Load Regulation	$\Delta V_{LOAD}$	$1mA \leq I_o \leq 100mA$	25°C		25	150	mV
		$1mA \leq I_o \leq 40mA$			15	75	
Bias Current	$I_B$		25°C		4.2	6.5	mA
			125°C			6	
Bias Current Change	$\Delta I_B$	$-20V \leq V_{IN} \leq -30V$	-30°C ~ 125°C			1.5	mA
		$1mA \leq I_o \leq 40mA$				0.1	
Output Noise Voltage	$V_N$	$10Hz \leq f \leq 100kHz$	25°C		82		uV
Ripple Rejection	RR	$-18.5V \leq V_{IN} \leq -28.5V$ , $f=120Hz$	25°C	37	44		dB
Dropout Voltage	$V_D$		25°C		1.7		V

### 3-TERMINAL 0.1A NEGATIVE VOLTAGE REGULATOR

### LM79Lxx

**LM79L18** (At specified virtual junction temperature,  $V_{IN} = -26V$ ,  $I_o = 40mA$  (Unless otherwise noted))

PARAMETER	SYMBOL	TEST CONDITION <sup>(Note 1)</sup>		MIN.	TYP.	MAX.	UNIT
Output Voltage <sup>(Note 2)</sup>	$V_{OUT}$		25°C	-17.3	-18	-18.7	V
		$1mA \leq I_o \leq 40mA$ $-20.5V \leq V_{IN} \leq -33V$	-30°C ~ 125°C	-17.1	-18	-18.9	
		$1mA \leq I_o \leq 70mA$		-17.1	-18	-18.9	
Line Regulation	$\Delta V_{LINE}$	$-20.7V \leq V_{IN} \leq -33V$	25°C		70	360	mV
		$-21V \leq V_{IN} \leq -33V$			64	300	
Load Regulation	$\Delta V_{LOAD}$	$1mA \leq I_o \leq 100mA$	25°C		27	180	mV
		$1mA \leq I_o \leq 40mA$			19	90	
Bias Current	$I_B$		25°C		4.7	6.5	mA
			125°C			6	
Bias Current Change	$\Delta I_B$	$-21V \leq V_{IN} \leq -33V$	-30°C ~ 125°C			1.5	mA
		$1mA \leq I_o \leq 40mA$				0.1	
Output Noise Voltage	$V_N$	$10Hz \leq f \leq 100kHz$	25°C		82		uV
Ripple Rejection	RR	$-23V \leq V_{IN} \leq -33V$ , $f=120Hz$	25°C	32	36		dB
Dropout Voltage	$V_D$		25°C		1.7		V

**LM79L24** (At specified virtual junction temperature,  $V_{IN} = -32V$ ,  $I_o = 40mA$  (Unless otherwise noted))

PARAMETER	SYMBOL	TEST CONDITION <sup>(Note 1)</sup>		MIN.	TYP.	MAX.	UNIT
Output Voltage <sup>(Note 2)</sup>	$V_{OUT}$		25°C	-23	-24	-25	V
		$1mA \leq I_o \leq 40mA$ $-27V \leq V_{IN} \leq -38V$	-30°C ~ 125°C	-22.8	-24	-25.2	
		$1mA \leq I_o \leq 70mA$		-22.8	-24	-25.2	
Line Regulation	$\Delta V_{LINE}$	$-27V \leq V_{IN} \leq -38V$	25°C		95	480	mV
		$-28V \leq V_{IN} \leq -38V$			78	400	
Load Regulation	$\Delta V_{LOAD}$	$1mA \leq I_o \leq 100mA$	25°C		41	240	mV
		$1mA \leq I_o \leq 40mA$			28	120	
Bias Current	$I_B$		25°C		4.8	6.5	mA
			125°C			6	
Bias Current Change	$\Delta I_B$	$-21V \leq V_{IN} \leq -38V$	-30°C ~ 125°C			1.5	mA
		$1mA \leq I_o \leq 40mA$				0.1	
Output Noise Voltage	$V_N$	$10Hz \leq f \leq 100kHz$	25°C		82		uV
Ripple Rejection	RR	$-29V \leq V_{IN} \leq -35V$ , $f=120Hz$	25°C	30	33		dB
Dropout Voltage	$V_D$		25°C		1.7		V



- Note 1. Pulse testing techniques are used to maintain the junction temperature as close to the ambient temperature as possible. Thermal effects must be taken into account separately.  
All characteristics are measured with a 0.33 $\mu$ F capacitor across the input and a 0.1 $\mu$ F capacitor across the output.
- Note 2. This specification applies only for DC power dissipation permitted by absolute maximum ratings.

## TYPICAL OPERATING CHARACTERISTICS

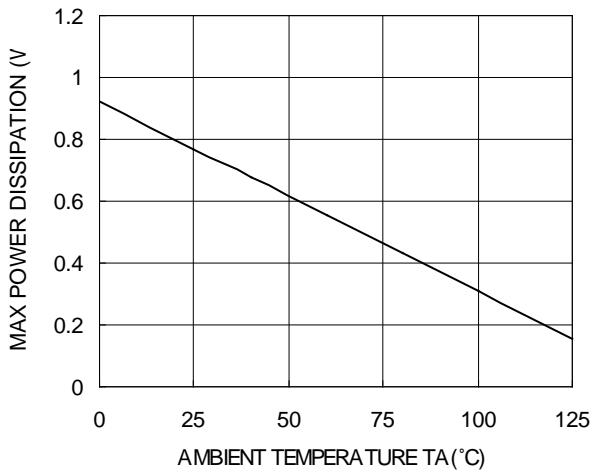

Power Dissipation vs. Ambient Temperature, TO-92

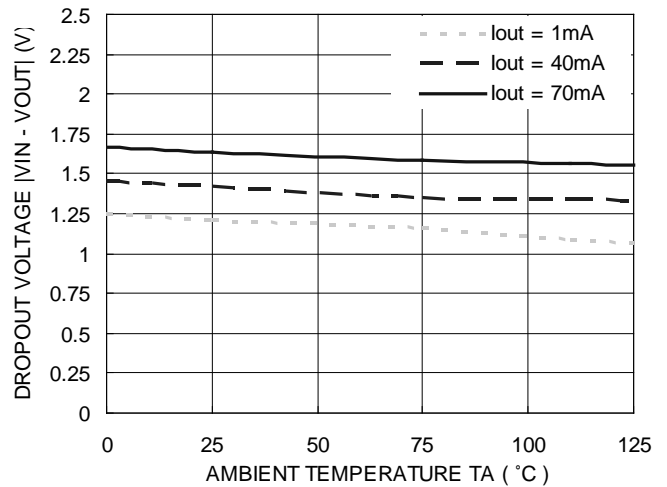

Dropout Voltage vs. Ambient Temperature

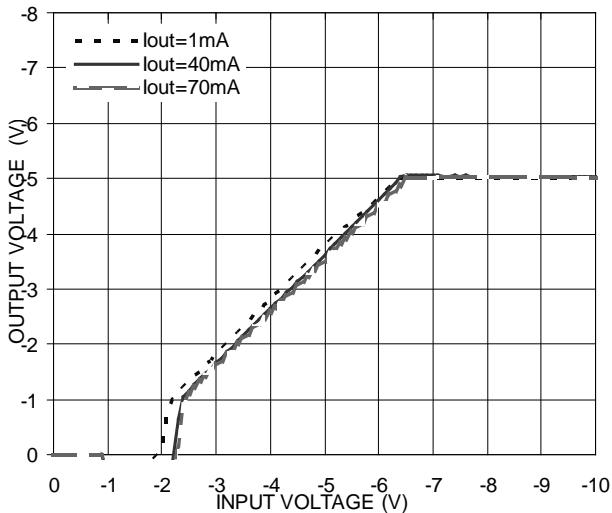

Output Voltage vs. Input Voltage

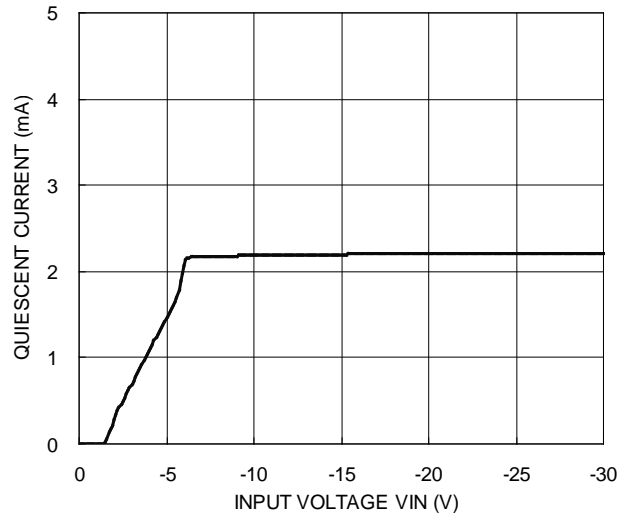

Quiescent Current vs. Input Voltage

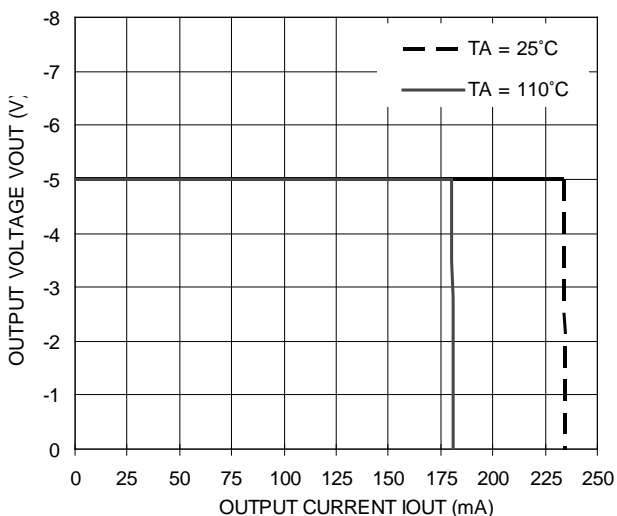

Output Voltage vs. Output Current

## REVISION NOTICE

The description in this datasheet is subject to change without any notice to describe its electrical characteristics properly.

单击下面可查看定价，库存，交付和生命周期等信息

[>>HTC\(泰进\)](#)