

FEATURES

- Wide Input Voltage from 2.7V to 6V
- Adjustable Output Voltage from 0.61V to VIN
- Continuous Output Current
 - 8A Continuous Output Current for Output Voltage from 0.61V to 1.2V
 - 7A Continuous Output Current and 8A peak current for Other Output Voltages
- Constant on Time (COT) Control
- Forced Continuous Conduction Mode (FCCM) for Light Load
- Stable with low ESR Ceramic Capacitors
- 1.2MHz Switching Frequency
- 100% Duty Cycle Operation for Low Dropout
- Junction Temperature Range from -40°C to 125°C
- Power Good (PG) Indicator
- Programable Soft-Start Time
- Cycle-by-Cycle Output Current Limit Protection
- Short Circuit and Over-Load Hiccup Protection
- Thermal Shutdown Protection
- LGA-24 (4mm×6mm×1.82mm) Package
- Pb-Free RoHS Compliant

APPLICATIONS

- Optical Module
- PoL Power Supply
- Data Center
- Solid-State and Hard Disk Drives
- Industrial & Medical System

DESCRIPTION

The M0508 is an 8A step-down switching mode Power SoC (System on Chip) with integrated controller, power MosFETs, inductor and input capacitors in LGA-24 package. The input voltage is from 2.7V to 6V and the switching frequency is fixed at 1.2MHz.

The M0508 provides high efficiency with COT control mode for fast transient response and good loop stability. It works on FCCM which keeps low output ripple and supports 100% duty cycle for low dropout.

The M0508 indicates faults by PG and provides short circuit and over-load hiccup protection and over temperature shutdown protection.

TYPICAL APPLICATION&EFFICIENCY

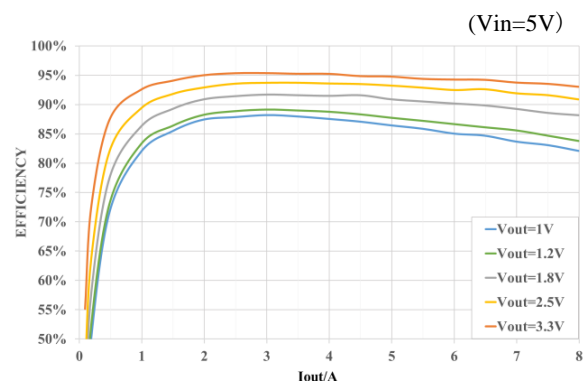
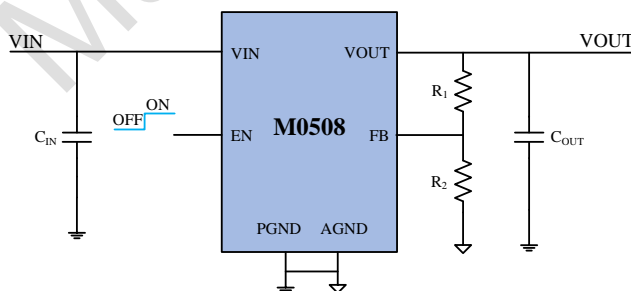



ORDERING INFORMATION

PART NUMBER	TOP MARKING	PACKAGE	MOQ	MSL LEVEL
M0508DLDD	M0508 YWWLLL	LGA-24 (4mm×6mm×1.82mm)	1500/ Tape & Reel	3

NOTES: Y: Year, WW: Week, LLL: Lot Number.

PACKAGE REFERENCE

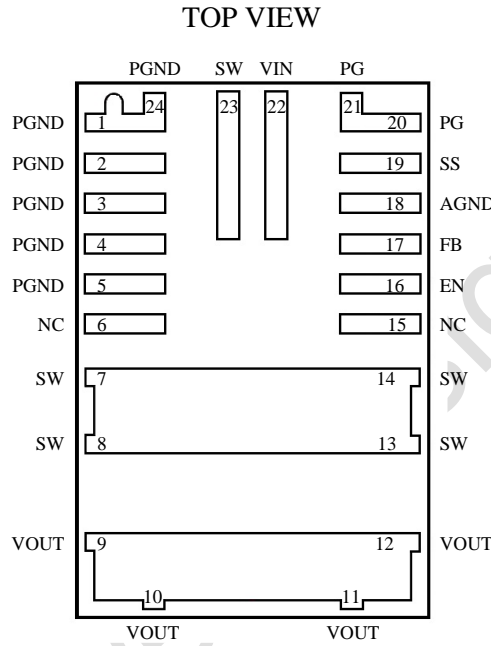

**PIN FUNCTIONS**

PIN #	NAME	DESCRIPTION
1,2,3,4,5,24	PGND	Power Ground.
6,15	NC	Not Connected.
7,8,13,14,23	SW	Not Connected. Internal SW Pad.
9,10,11,12	VOUT	Output Voltage. Connect this pin with the load. Output capacitor is recommended to be placed between VOUT and PGND.
16	EN	Enable Control. Pull this pin low shuts the chip down. Pull it up high enables the chip.
17	FB	Feedback. Connect this pin with an external resistor divider from the output to AGND to set the output voltage.
18	AGND	Analog Ground.
19	SS	Soft Start. A decoupling ceramic capacitor is recommended to be placed close to this pin. The capacitance determines the soft-start time.
20,21	PG	Power Good. The output of PG is an open drain, a pull-up resistor to power source is needed if used. If the chip works normally, PG is pulled high, else, PG is latched low.
22	VIN	Input Voltage. VIN supplies power to all the internal control circuitry and the power switch. A decoupling capacitor to PGND is recommended to be placed close to VIN directly.



FUNCTIONAL BLOCK DIAGRAM

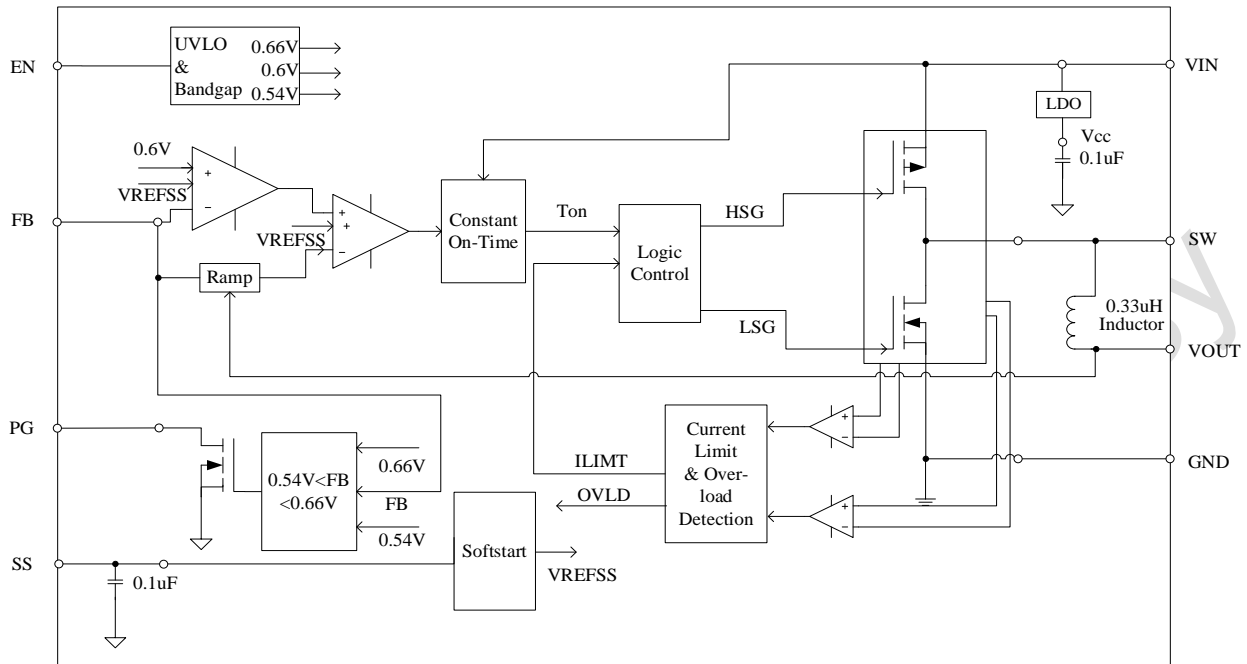



ABSOLUTE MAXIMUM RATINGS

	SYMBOL	MIN	MAX	UNIT
Voltage at Pins	V_{IN}	-0.3	6.5	V
Voltage at Other Pins		-0.3	6	V
Junction Temperature Range	T_J	-40	125	°C
Storage Temperature Range	T_S	-55	150	°C
Power Dissipation ($T_A=+25^{\circ}\text{C}$)	P_D ^{Notes 1)}		2.85	W

RECOMMENDED OPERATING CONDITIONS

	SYMBOL	MIN	MAX	UNIT
Input Voltage Range	V_{IN}	2.7	5.5	V
Output Voltage Range	V_{OUT}	0.61	V_{IN}	V
Output Current	I_{OUT}		8	A
Junction Temperature Range	T_J	-40	125	°C

THERMAL RESISTANCE

	SYMBOL	MIN	MAX	UNIT
Junction to Ambient	θ_{JA} ^{Notes 2)}		35	°C/W
Junction to Case	θ_{JC} ^{Notes 2)}		22	°C/W

NOTES:

- 1) The maximum allowable continuous power dissipation at any ambient temperature (T_A) is calculated by $P_D(\text{max})=(T_J(\text{max})-T_A)/\theta_{JA}$. Exceeding the maximum allowable power dissipation will cause excessive die temperature, and the power module will go into thermal shutdown.
- 2) Measured on EVB, 4-layer PCB 2oZ.

**ELECTRICAL CHARACTERISTICS** $V_{IN}=5V$, $V_{OUT}=1V$, $T_A=25^{\circ}C$, unless otherwise noted.

PARAMETERS	SYMBOL	CONDITION	MIN	TYP	MAX	UNIT
Input Voltage	V_{IN}		2.7		6.0	V
Input under Voltage Lockout Threshold	V_{UVLO}	V_{IN} Increasing	2.3	2.4	2.5	V
Input under Voltage Lockout Hysteresis			200	250	300	mV
Input over Voltage Lockout Threshold	V_{OVLO}	V_{IN} Increasing	6.5	6.7	6.9	V
Input over Voltage Lockout Hysteresis			200	450	600	mV
Shutdown Current	I_{SD}	$V_{EN}=0$, $V_{IN}=5.5V$		0.1	1	μA
Quiescent Current (No Switching)	I_Q	$V_{FB}=0.63V$	400	500	700	μA
EN On Threshold		V_{EN} Increasing	1.17	1.20	1.23	V
EN Off Threshold		V_{EN} Decreasing	1.07	1.1	1.13	V
EN Internal Pull-Down Resistor			800	1000	1200	k Ω
Feedback Voltage	V_{FB_REF}		604	610	616	mV
HS Switch Current Limit			9.8	11		A
Switching Frequency	F_{SW}			1.2		MHz
Soft-Start Time	T_{SS}	C_{SS} NC	5	6	7	ms
PG Output Low Voltage		$V_{FB}=5V$, sink 1mA		0.2	0.3	V
PG Under Voltage Rise Threshold		V_{FB} in respect to the regulation	-13	-10	-7	%
PG Under Voltage Hysteresis Threshold		V_{FB} in respect to the regulation	-8	-5	-2	%
PG Over Voltage Fall Threshold		V_{FB} in respect to the regulation	5	10	15	%
PG Over Voltage Hysteresis Threshold		V_{FB} in respect to the regulation	2	4	8	%
PG Delay	T_{PG_DELAY}		15	20	40	μs
Thermal Shutdown				160		$^{\circ}C$
Thermal Shutdown Hysteresis				30		$^{\circ}C$



TYPICAL PERFORMANCE CHARACTERISTICS

$V_{IN}=5V$ and $V_{OUT}=1V$, $T_A=25^{\circ}C$, unless otherwise noted.

Line Regulation

$V_{OUT}=1V/1.2V/1.8V/2.5V/3.3V$, $I_{OUT}=8A$,

$V_{IN}=2.7\sim 6V$

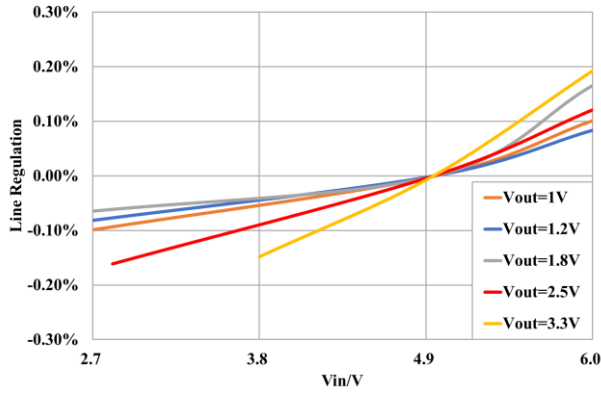

Load Regulation

$V_{IN}=5V$, $V_{OUT}=1V/1.2V/1.8V/2.5V/3.3V$,

$I_{OUT}=0\sim 8A$

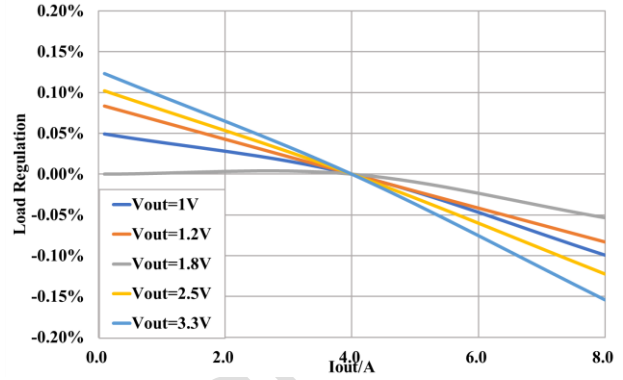

Efficiency

$V_{IN}=5V$, $V_{OUT}=1V/1.2V/1.8V/2.5V/3.3V$,

$I_{OUT}=0\sim 8A$

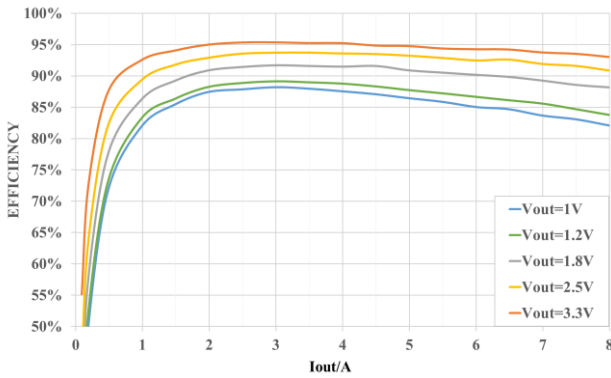

Efficiency

$V_{IN}=3.3V$, $V_{OUT}=1V/1.2V/1.8V/2.5V$,

$I_{OUT}=0\sim 8A$

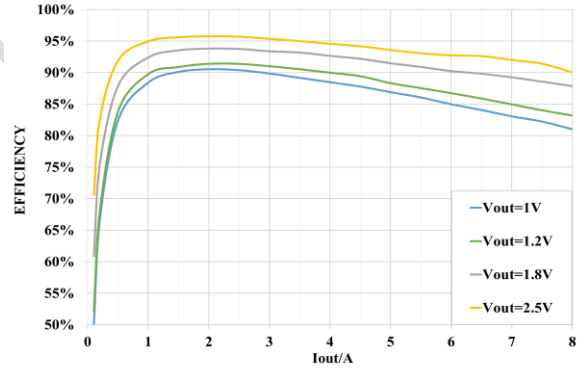



TYPICAL PERFORMANCE CHARACTERISTICS (continued)

$V_{IN}=5V$ and $V_{OUT}=1V$, $T_A=25^{\circ}C$, unless otherwise noted.

VIN Start-up

$I_{OUT}=0A$

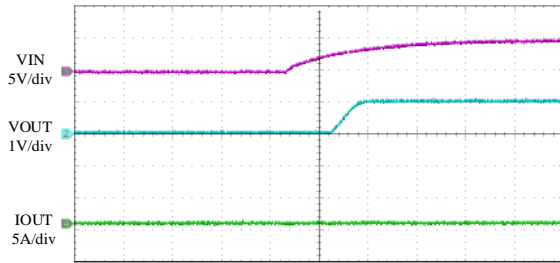

20ms/div

VIN Start-up

$I_{OUT}=8A$

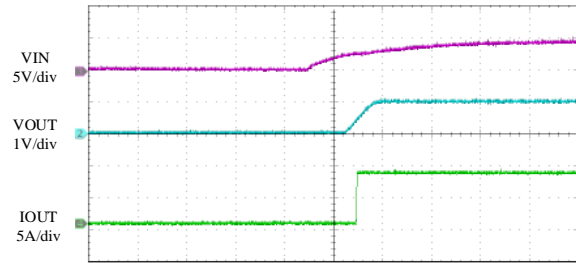

20ms/div

VIN Shutdown

$I_{OUT}=0A$

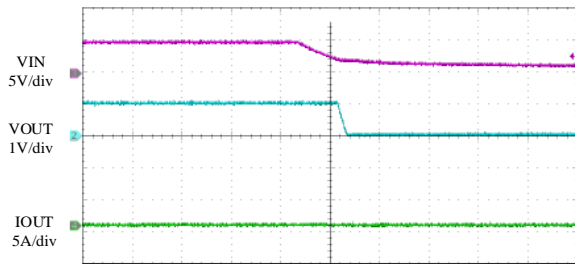

20ms/div

VIN Shutdown

$I_{OUT}=8A$

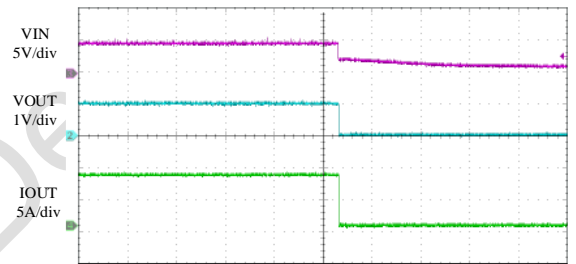

20ms/div

EN Start-up

$I_{OUT}=0A$

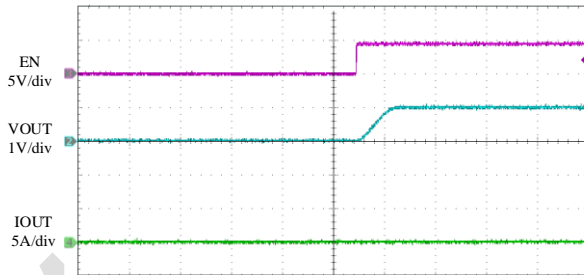

20ms/div

EN Start-up

$I_{OUT}=8A$

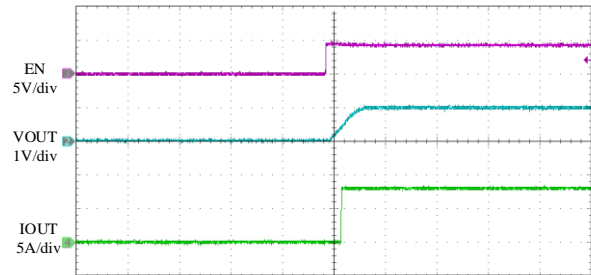

20ms/div



TYPICAL PERFORMANCE CHARACTERISTICS (continued)

$V_{IN}=5V$ and $V_{OUT}=1V$, $T_A=25^{\circ}C$, unless otherwise noted.

EN Shut-down

$I_{OUT}=0A$

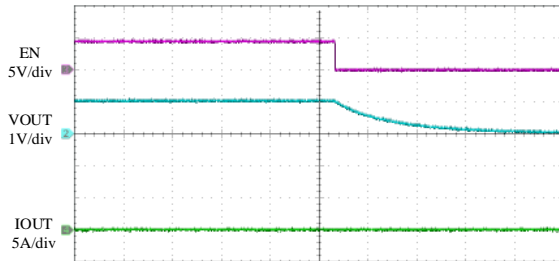

400ms/div

EN Shut-down

$I_{OUT}=8A$

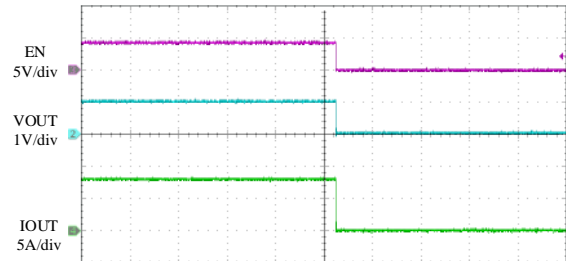

20ms/div

SCP Entry

$I_{OUT}=0A$

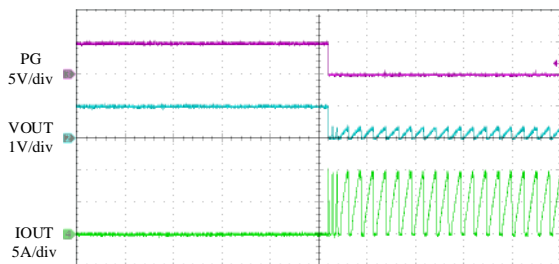

20ms/div

SCP Entry

$I_{OUT}=8A$

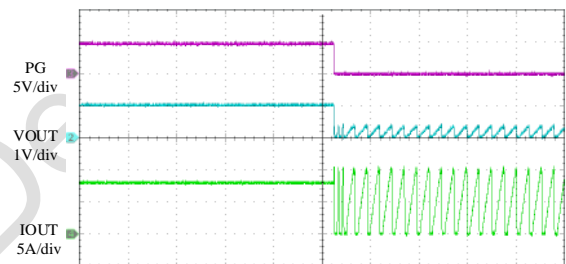

20ms/div

SCP Recovery

$I_{OUT}=0A$

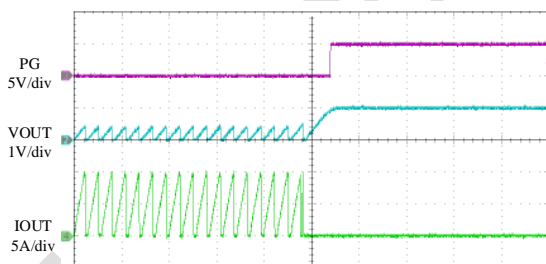

20ms/div

SCP Recovery

$I_{OUT}=8A$

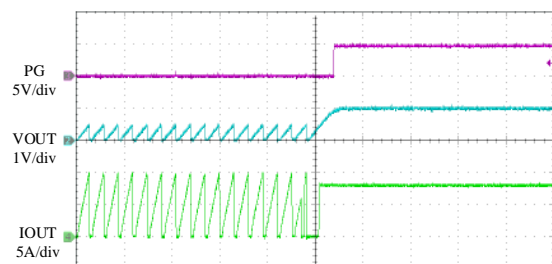

20ms/div



TYPICAL PERFORMANCE CHARACTERISTICS (continued)

$V_{IN}=5V$ and $V_{OUT}=1V$, $T_A=25^{\circ}C$, unless otherwise noted.

VOUT Ripple

$I_{OUT}=0A$

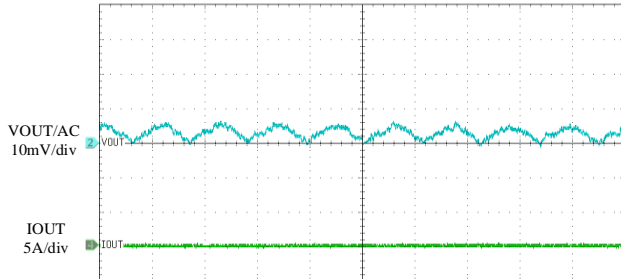

800ns/div

VOUT Ripple

$I_{OUT}=8A$

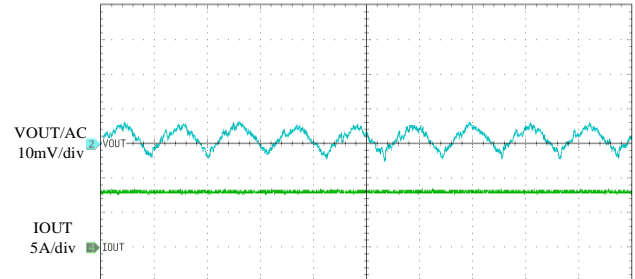

800ns/div

Load Transient

$I_{OUT}=0A$ to $4A$, $1A/\mu s$

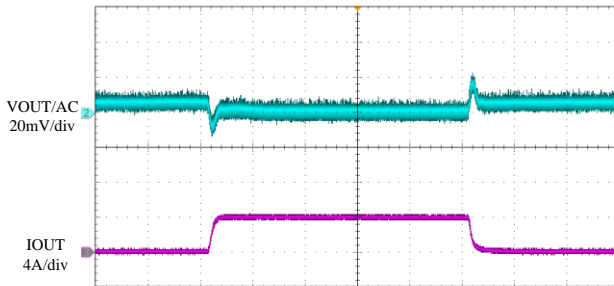

100μs/div

Load Transient

$I_{OUT}=0A$ to $8A$, $1A/\mu s$

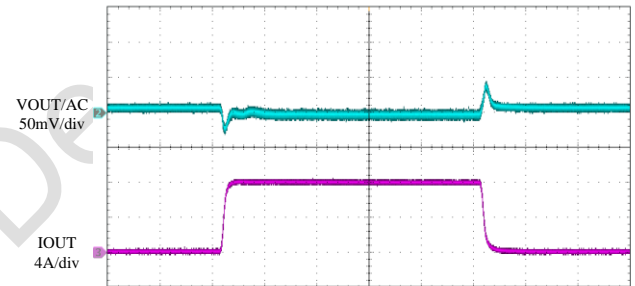

100μs/div

Load Transient

$I_{OUT}=4A$ to $8A$, $1A/\mu s$

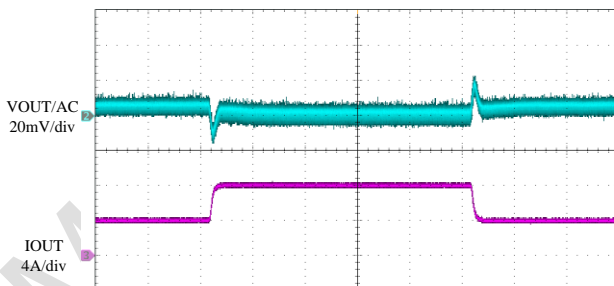

100μs/div



OPERATION

The M0508 is an 8A synchronous step-down switching mode Power SoC with integrated high-side and low-side power MosFETs, inductor and input decoupling capacitor in LGA-24 package. Only FB resistors, input and output capacitors are needed to complete the design over 2.7V to 6V input voltage range. The M0508 supports output voltage of 0.61V to 6V with the fixed switching frequency of 1.2MHz.

M0508 works on COT control mode that offers excellent transient response over the wide range of input voltage. M0508 operates in forced continuous conduction mode (FCCM) which keeps low output ripple. M0508 can work on 100% duty cycle when the dropout between input and output is low. The soft start time of M0508 is 6ms internally, which also can be programmed by the external capacitors.

Fully integrated protection features include OCP, UVP, OTP and all these faults can be indicated by PG. The protection function details are shown below.

OVER CURRENT PROTECTION (OCP)

M0508 has a typical cycle-by-cycle High-Side current limit protection to prevent inductor current from running away. When the High-Side switch reaches the current limit, M0508 will enter hiccup mode. It will stop switching for a pre-determined period of time and automatically start up again. It always starts up with soft-start to limit inrush current and avoid output overshoot.

OVER TEMPERATURE PROTECTION (OTP)

M0508 will stop switching when the junction temperature exceeds 160 °C. The device will power up again when the junction temperature drops below 130°C.



USER GUIDE

Output Voltage

The output voltage is set by the external feedback resistor divider as the typical application circuit on Page 1. The bottom feedback resistor R_2 can impact the loop stability, which is recommended to be between 10 k Ω and 60 k Ω . For any chosen R_2 , the top feedback resistor R_1 can be calculated as:

$$R_1 = R_2 \cdot \left(\frac{V_{OUT}}{V_{FB}} - 1 \right)$$

Table 1 lists the recommended feedback resistor values for common output voltages.

Table 1: FB Resistor Values for Common Output Voltages.

$V_{OUT}(V)$	$R_1(k\Omega)$	$R_2(k\Omega)$
3.3	133	30
1.8	60.4	30.9
1.2	30	30.9
1.0	19.3	30

And a feedforward capacitor is recommended for better load transient response, which typical value is 2.2nF.

Input Capacitor Selection

The input current of the step-down converter is discontinuous with sharp edges, therefore, placing input filter capacitors is necessary. For better performance, low ESR ceramic capacitors with X5R or X7R dielectrics are highly recommended because of their lowest temperature variations. The RMS current of the input capacitors is calculated:

$$I_{CIN_RMS} = I_{OUT} \sqrt{D(1-D)}$$

in which D is the Duty Cycle and when the current is continuous, $D = V_{OUT}/V_{IN}$; I_{OUT} is the output load current. As the equation above, when D is 0.5, the highest RMS current is approximately:

$$I_{CIN_RMS} = \frac{1}{2} \times I_{OUT}$$

So, it is recommended to choose the capacitors with the RMS current rating higher than $1/2 I_{OUT}$.

The power dissipation on the input capacitor can be estimated with the RMS current and the ESR.

Electrolytic or tantalum capacitors can also be used.

There has been a small size 0.1 μ F ceramic capacitor placed close to VIN and PGND in M0508 already. The input voltage ripple caused by the capacitor can be calculated as:

$$\Delta V_{CIN} = \frac{I_{OUT}}{F_{SW} \cdot C_{IN}} \cdot \frac{V_{OUT}}{V_{IN}} \cdot \left(1 - \frac{V_{OUT}}{V_{IN}} \right)$$

in which, F_{SW} is switching frequency of 1.2MHz.

Output Capacitor Selection

Output capacitors are required to keep output voltage stable. To minimize the output voltage ripple, low ESR ceramic capacitors should be used. The output voltage ripple can be estimated as:

$$\Delta V_{OUT} = \frac{V_{OUT}}{8F_{SW}^2 C_{OUT} L} \cdot \left(1 - \frac{V_{OUT}}{V_{IN}} \right)$$

In which, L is the inductor fixed at 0.33 μ H internally.

If electrolytic or tantalum capacitors are used, the ESR will dominate the output voltage ripple as:

$$\Delta V_{OUT} = R_{ESR} \cdot \frac{V_{OUT}}{F_{SW} L} \cdot \left(1 - \frac{V_{OUT}}{V_{IN}} \right)$$

Enable Control

When input voltage is above the under-voltage-lock-out threshold, M0508 can be enabled by pulling the EN pin to above 1.21V and will be disabled if the EN pin is below 1.1V. It is recommended to pull up to VIN with the resistor about 100k Ω .

Power Good Indicator

M0508 has an open drain PG Indicator. PG will be pulled up if output voltage is within $\pm 10\%$ of regulation, otherwise PG is pulled down by internal NMos. A pull-up resistor to VIN or VOUT is needed if used and it is recommended to choose the resistor about 100k Ω .

Soft Start Time

The soft start time of M0508 is 6ms internally. The time can be increased by adding an external capacitor C_{SS} between SS and AGND. C_{SS} can be calculated as:

$$C_{SS}(nF) = \frac{T_{SS}(ms) \times 8(\mu A)}{0.61(V)} - 100nF$$

PCB Layout Guide

To optimize the electrical and thermal performance, some PCB layout guidelines should be considered as below:

1. Use wide trace for the high current paths and keep it as short as possible. It helps to minimize the PCB conduction loss and thermal stress.
2. Place the input decoupling capacitor close to VIN and PGND.
3. Connect all feedback network to FB shortly.
4. Keep the SS capacitor and FB network components away from the SW.
5. The PGND should be connected to a strong ground plane for better heat dissipation and noise protection.

Figure 1 gives a good example of the recommended layout.

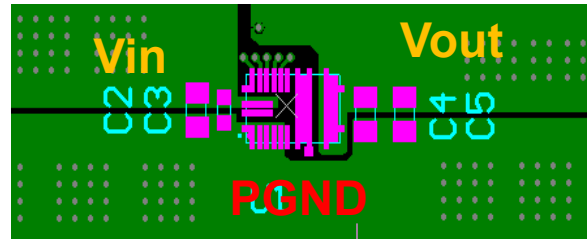

(a) Top Layer

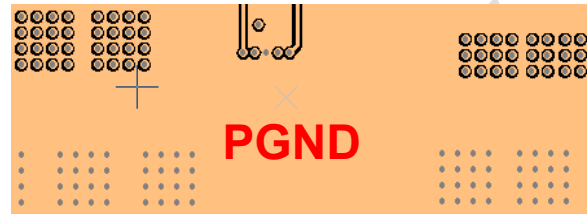

(b) Inner Layer 1



(c) Inner Layer 2

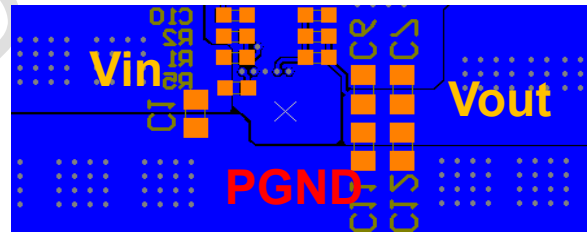

(d) Bottom Layer

Figure 1. Recommended Layout



TYPICAL APPLICATION

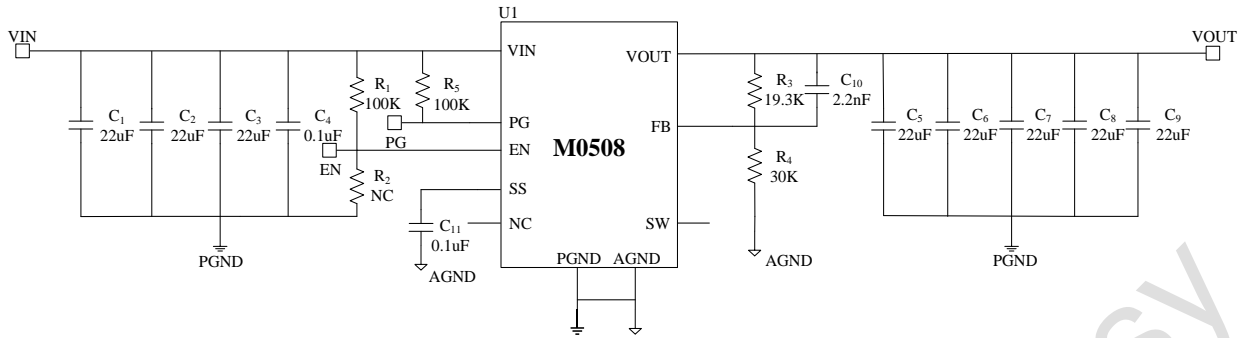

Figure 2. Typical Application Circuits of M0508 for 1V Output

Table 2: Reference Design

VOUT	CIN	COUT (Ripple<1%)	C ₁₀	R ₃	R ₄
3.3V	47uF+3×22uF	5×22uF	2.2nF	133kΩ	30kΩ
1.2V	2×22uF	4×22uF	2.2nF	30kΩ	30.9kΩ
1.0V	2×22uF	4×22uF	2.2nF	19.3kΩ	30kΩ

NOTES:

CIN is the sum of the input capacitors, COUT is the sum of the output capacitors, please refer to Figure 2 for parameters of other components.



PACKAGE INFORMATION

LGA-24 (4mm×6mm×1.82mm) Package

TOP VIEW

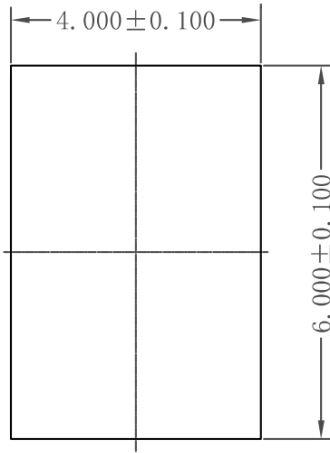

SIDE VIEW

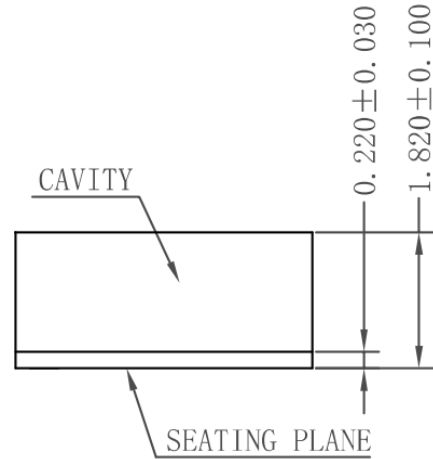

BOTTOM VIEW

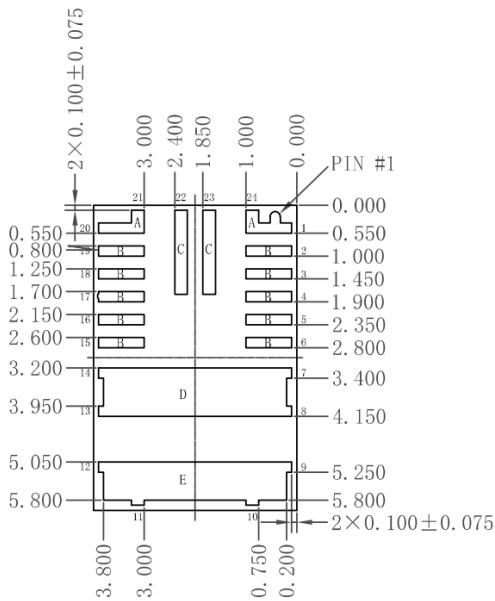

RECOMMENDED LAND PATTERN

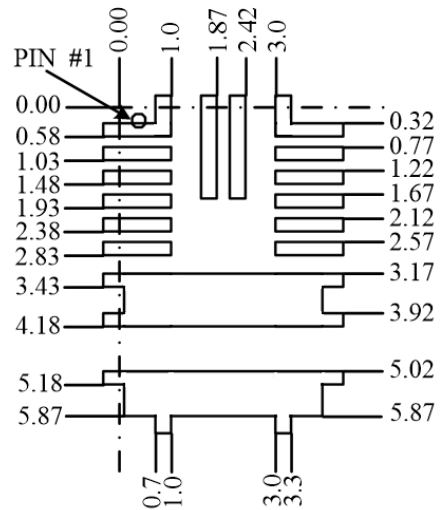

NOTES:

All dimensions are in MM.

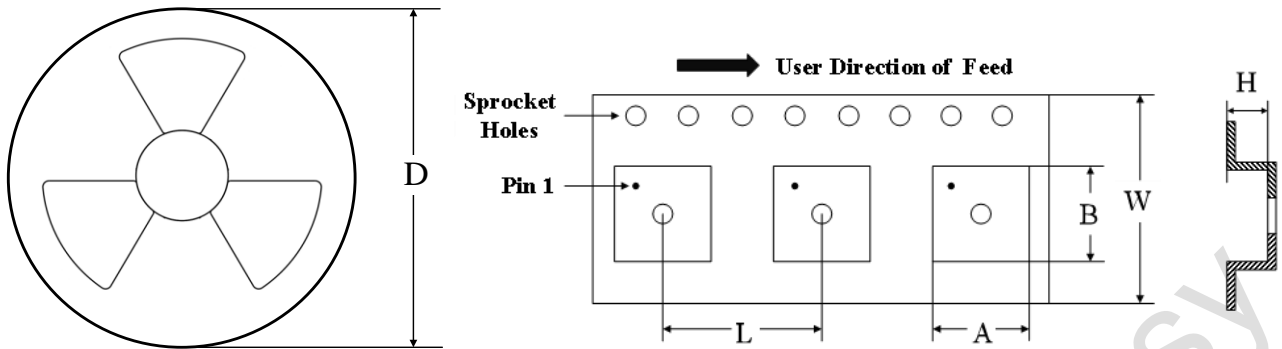
**CARRIER INFORMATION**

PART NUMBER	PACKAGE	QUANTITY /REEL	D	A	B	L	W	H
M0508DLDD	LGA-24 (4mm×6mm×1.82mm)	1500	13 in	4.3mm	6.3mm	12mm	16mm	2.12mm

单击下面可查看定价，库存，交付和生命周期等信息

[>>iModule\(沃芯\)](#)