

2.00mm Pitch Wire To Board Connector

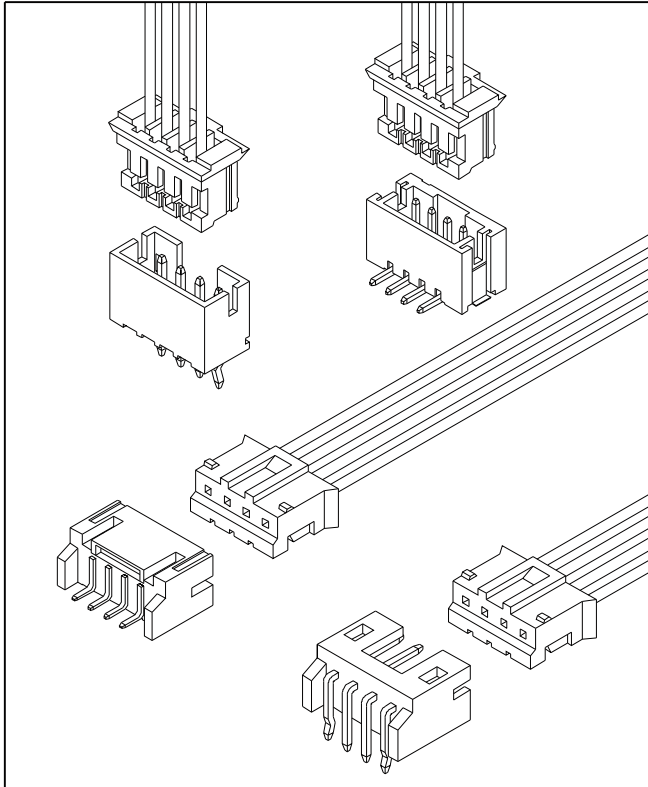

Specification

Circuits	02 - 16
Pitch	2.00mm
Current Rating	3.0A AC/DC (AWG#24)
	2.5A AC/DC (AWG#26)
	1.5A AC/DC (AWG#28)
	1.0A AC/DC (AWG#30)
Voltage Rating	100V AC/DC
Contact Resistance	10mΩ MAX.
Withstand Voltage	800V AC/minute
Insulation Resistance	1,000MΩ MIN.
Temperature Range	-25°C - +85°C
Applicable Wire Range	AWG #24 - #30
Applicable P.C.B Thickness	0.8mm - 1.6mm
Applicable P.C.B Hole Dia.	∅0.8mm ± 0.05

Assembly Layout

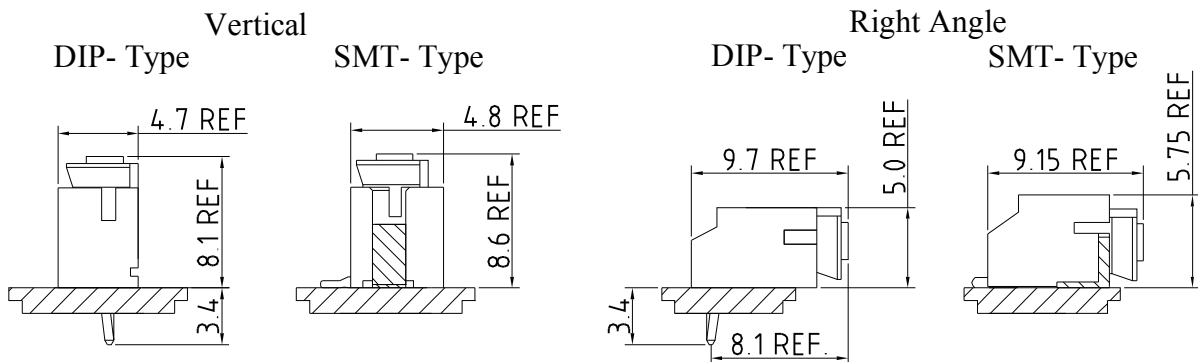

IPCW200 * ** * * * * *

① ② ③ ④ ⑤ ⑥ ⑦ ⑧

① Series Type. IPCW200

② Connector Type.

T: Terminal

W: Wafer

H: Housing

③ Pin code.

Terminal: Serial number

Wafer or Housing: x row x pin number of row

④ Material code.

⑤ Appearance code.

⑥ Internal code
Wafer

B: Vertical SMT TYPE 02

A: Right Angle SMT TYPE 02

⑦ Company code.

⑧ Other code.

Wafer

V: Vertical Type

R: Right Angle

S: Vertical SMT TYPE

M: Right Angle SMT TYPE

2.00mm Pitch Wire To Board Connector

Unit : mm

Terminal

Features

Use with: IPCW200 Series Housing

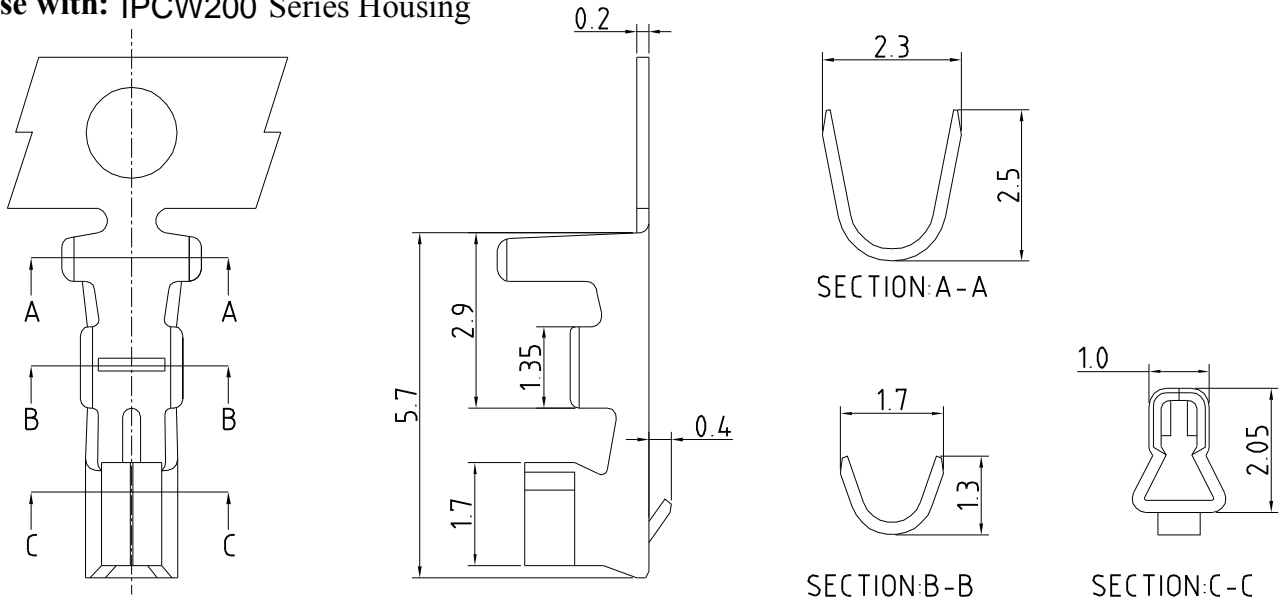

CONTACT INFORMATION

Part No.	Wire Range	Insulation O.D.	Material	Finish	Q'ty/Reel
IPCW200T01*D	AWG #24-#30	1.40mm(MAX.)	Brass	See note	10,000 pcs
IPCW200T02*D			Phosphor bronze		

Housing

Features

Available Number of Circuits: 02 - 16

Material: Regular Thermoplastic 94V-0

Use with: IPCW200 Crimp Terminal

Mates with :IPCW200 Series Wafer

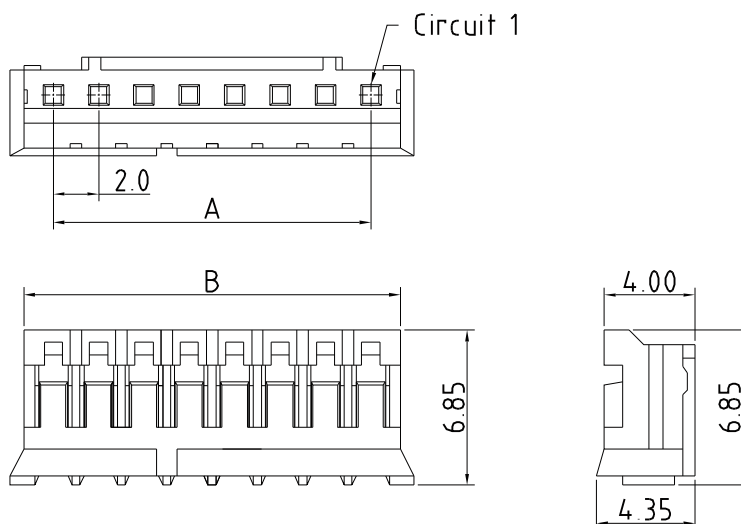

Dimension and Order Information

Circuits	Part No.	DIM.(mm)	
		A	B
2	IPCW200H12*	2.00	4.60
3	IPCW200H13*	4.00	6.60
4	IPCW200H14*	6.00	8.60
5	IPCW200H15*	8.00	10.60
6	IPCW200H16*	10.00	12.60
7	IPCW200H17*	12.00	14.60
8	IPCW200H18*	14.00	16.60
9	IPCW200H19*	16.00	18.60
10	IPCW200H1A*	18.00	20.60
11	IPCW200H1B*	20.00	22.60
12	IPCW200H1C*	22.00	24.60
13	IPCW200H1D*	24.00	26.60
14	IPCW200H1E*	26.00	28.60
15	IPCW200H1F*	28.00	30.60
16	IPCW200H1G*	30.00	32.60

2.00mm Pitch Wire To Board Connector

Unit : mm

Wafer Vertical

Features

Available Number of Circuits : 02 - 16

Material : Regular Thermoplastic 94V-0

Contact: 0.5mm(.020") Copper Alloy, Tin-plated

Mates with : IPCW200 Series Housing

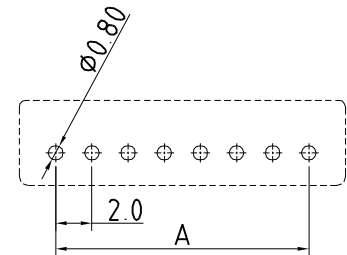
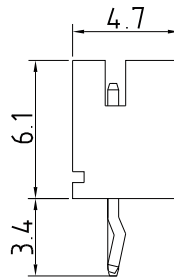
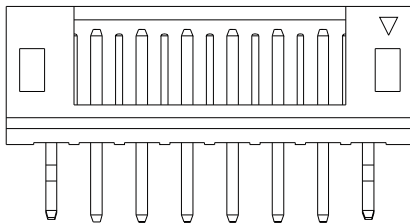
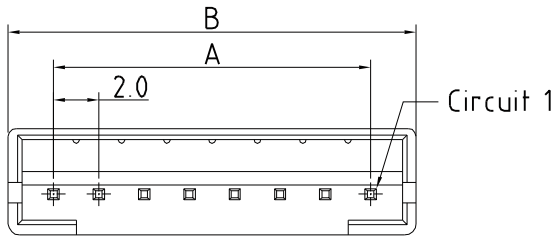

P.C.B LAYOUT

Dimension and Order Information

Circuits	Part No.	DIM.(mm)	
		A	B
2	IPCW200W12*V	2.00	6.00
3	IPCW200W13*V	4.00	8.00
4	IPCW200W14*V	6.00	10.00
5	IPCW200W15*V	8.00	12.00
6	IPCW200W16*V	10.00	14.00
7	IPCW200W17*V	12.00	16.00
8	IPCW200W18*V	14.00	18.00
9	IPCW200W19*V	16.00	20.00
10	IPCW200W1A*V	18.00	22.00
11	IPCW200W1B*V	20.00	24.00
12	IPCW200W1C*V	22.00	26.00
13	IPCW200W1D*V	24.00	28.00
14	IPCW200W1E*V	26.00	30.00
15	IPCW200W1F*V	28.00	32.00
16	IPCW200W1G*V	30.00	34.00

Wafer Right Angle

Features

Available Number of Circuits : 02 - 16

Material : High Temperature Thermoplastic 94V-0

Contact: 0.5mm(.020") Copper Alloy, Tin-plated

Mates with : IPCW200 Series Housing

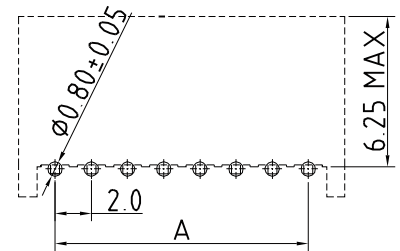
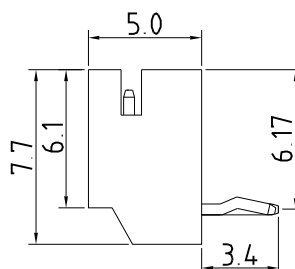
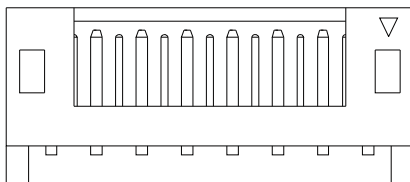
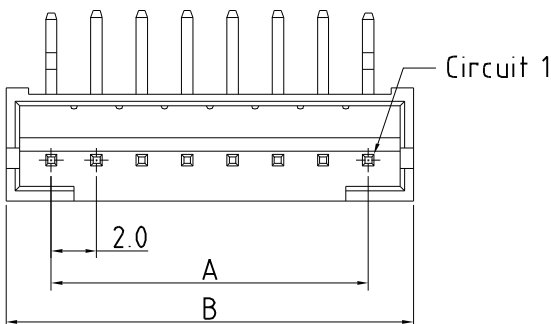

P.C.B LAYOUT

Dimension and Order Information

Circuits	Part No.	DIM.(mm)	
		A	B
2	IPCW200W12*R	2.00	6.00
3	IPCW200W13*R	4.00	8.00
4	IPCW200W14*R	6.00	10.00
5	IPCW200W15*R	8.00	12.00
6	IPCW200W16*R	10.00	14.00
7	IPCW200W17*R	12.00	16.00
8	IPCW200W18*R	14.00	18.00
9	IPCW200W19*R	16.00	20.00
10	IPCW200W1A*R	18.00	22.00
11	IPCW200W1B*R	20.00	24.00
12	IPCW200W1C*R	22.00	26.00
13	IPCW200W1D*R	24.00	28.00
14	IPCW200W1E*R	26.00	30.00
15	IPCW200W1F*R	28.00	32.00
16	IPCW200W1G*R	30.00	34.00

2.00mm Pitch Wire To Board Connector

Unit : mm

Wafer Vertical SMT TYPE

Features

Available Number of Circuits : 02 - 08

Material : High Temperature Thermoplastic 94V-0

Contact: 0.5mm(.020") Copper Alloy, Tin-plated

Mates with : IPCW200 Series Housing

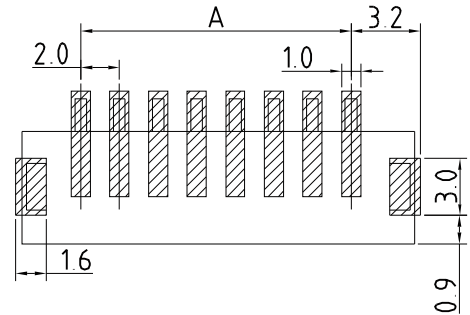
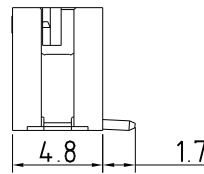
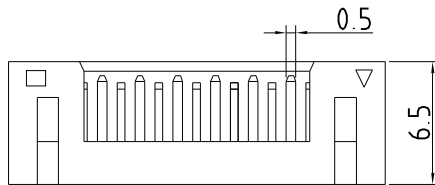
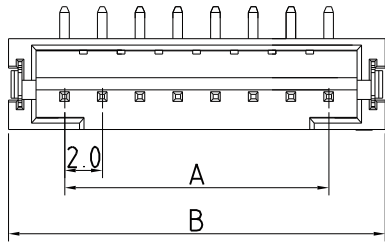

P.C.B LAYOUT

Dimension and Order Information

Circuits	Part No.	DIM.(mm)	
		A	B
2	IPCW200W12*S	2.00	7.95
3	IPCW200W13*S	4.00	9.95
4	IPCW200W14*S	6.00	11.95
5	IPCW200W15*S	8.00	13.95
6	IPCW200W16*S	10.00	15.95
7	IPCW200W17*S	12.00	17.95
8	IPCW200W18*S	14.00	19.95

Wafer Vertical SMT TYPE 02

Features

Available Number of Circuits : 09 - 16

Material : High Temperature Thermoplastic 94V-0

Contact: 0.5mm(.020") Copper Alloy, Tin-plated

Mates with : IPCW200 Series Housing

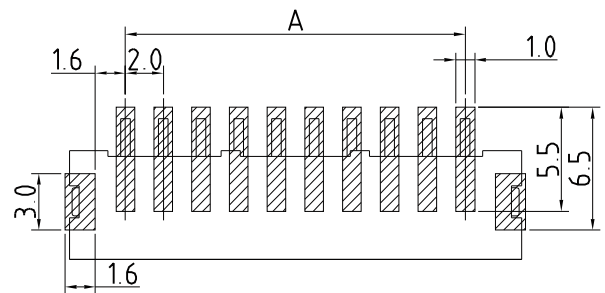
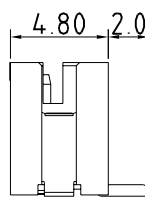
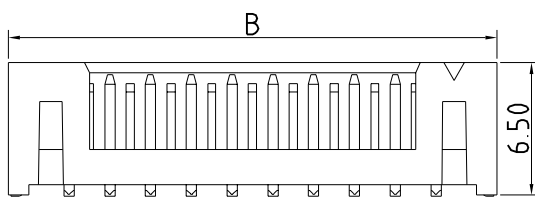
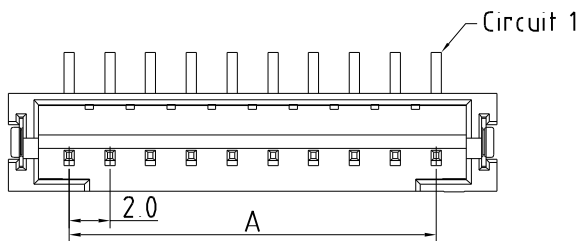

P.C.B LAYOUT

Dimension and Order Information

Circuits	Part No.	DIM.(mm)	
		A	B
9	IPCW200W19*B*S	16.00	21.95
10	IPCW200W1A*B*S	18.00	23.95
11	IPCW200W1B*b*S	20.00	25.95
12	IPCW200W1C*B*S	22.00	27.95
13	IPCW200W1D*B*S	24.00	29.95
14	IPCW200W1E*B*S	26.00	31.95
15	IPCW200W1F*B*S	28.00	33.95
16	IPCW200W1G*B*S	30.00	35.95

2.00mm Pitch Wire To Board Connector

Unit : mm

Wafer Right Angle SMT TYPE 02

Features

Available Number of Circuits : 02 - 05

Material : High Temperature Thermoplastic 94V-0

Contact: 0.5mm(.020") Copper Alloy, Tin-plated

Mates with : IPCW200 Series Housing

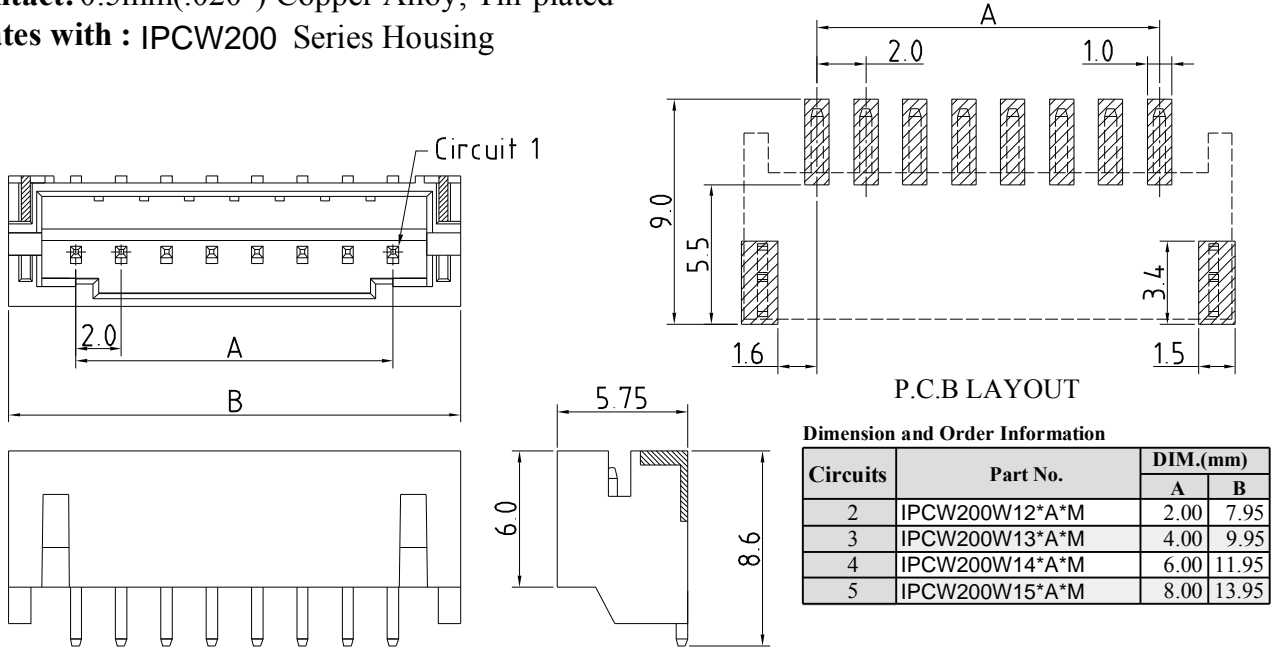

Wafer Right Angle SMT TYPE

Features

Available Number of Circuits : 06 - 16

Material : High Temperature Thermoplastic 94V-0

Contact: 0.5mm(.020") Copper Alloy, Tin-plated

Mates with : IPCW200 Series Housing

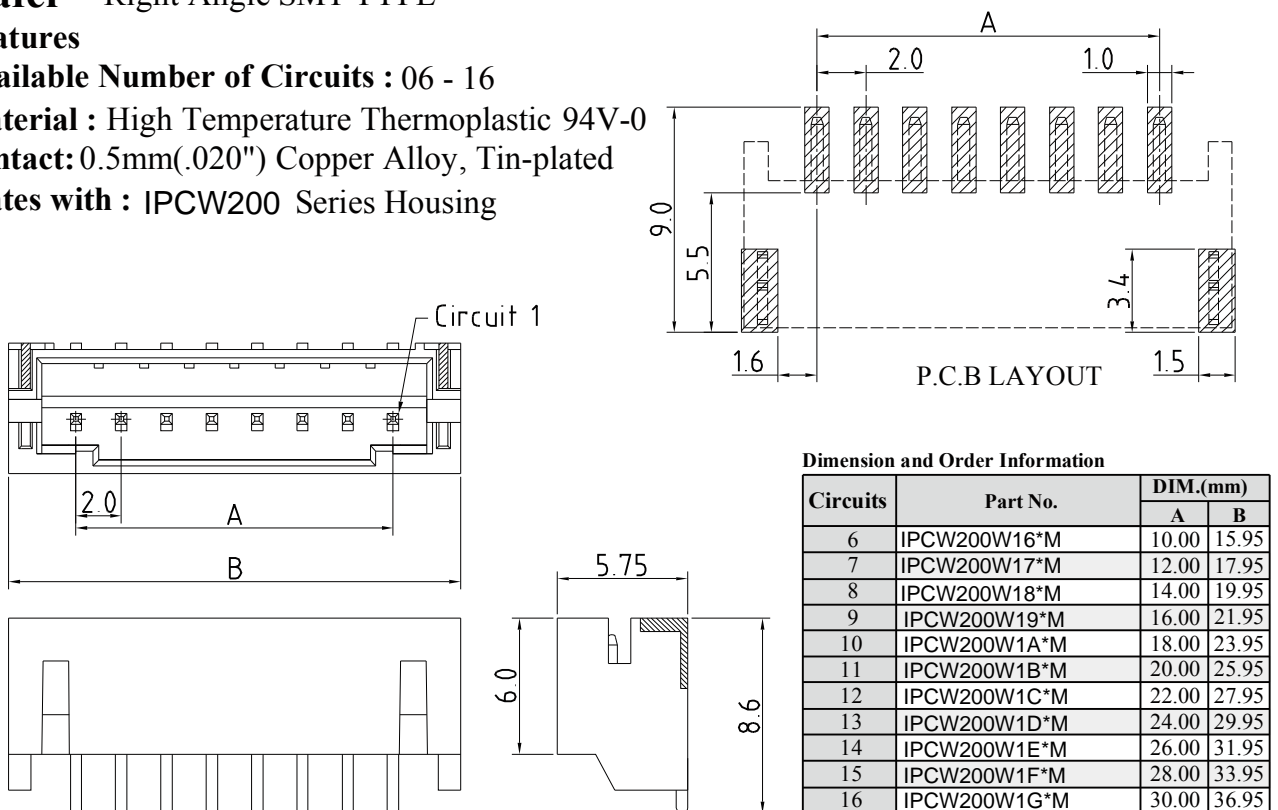

单击下面可查看定价，库存，交付和生命周期等信息

[>>INCP](#)