

# Engineer Drawing

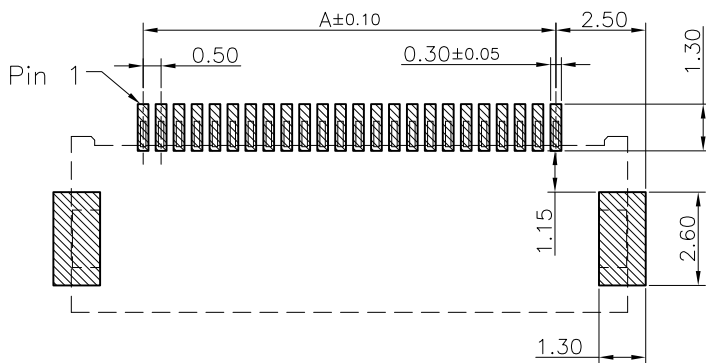

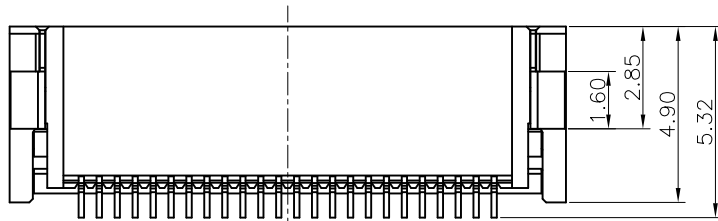
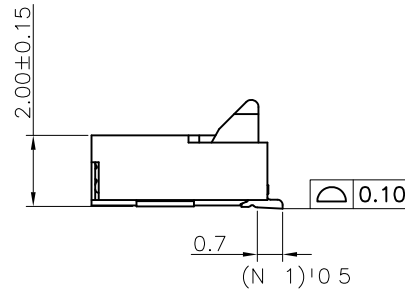
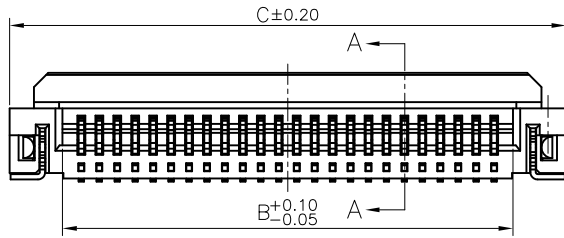
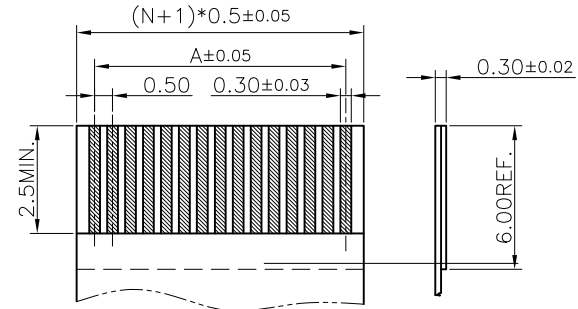
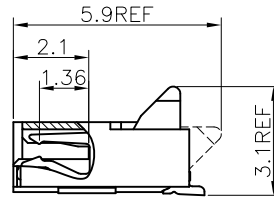
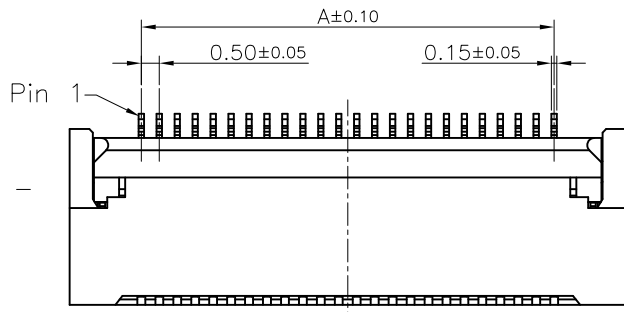

## NOTES:

- MATERIAL:**  
HOUSING: HIGHT-TEMP PLASTIC,UL 94-V0,COLOR:NATURE;  
COVER: HIGHT-TEMP PLASTIC,UL 94-V0,COLOR:BLACK;  
CONTACT: COPPER ALLOY;  
LEG: COPPER ALLOY;
- PLATING:**  
CONTACT AND SOLDER AREA GOLD FLASH PLATED ON  
NICKEL OVER ALL.  
LEG: TIN PLATED ON NICKEL OVER ALL.
- RATING:**  
CURRENT RATING: 0.5A AC/DC  
VOLTAGE RATING: 50V AC/DC  
TEMPERATURE RANGE: -40°C~+85°C;
- PART NO:**

IPFP05202 \*\* \* \* \* \*

- |             |           |         |               |         |              |
|-------------|-----------|---------|---------------|---------|--------------|
| ①           | ②         | ③       | ④             | ⑤       | ⑥            |
| Series Type | Pin code. | Plating | Company code. | Packing | Lead Free HF |

CKTS	DIM A	DIM B	DIM C	CKTS	DIM A	DIM B	DIM C
4	1.50	2.55	5.50	33	16.00	17.05	20.00
5	2.00	3.05	6.00	34	16.50	17.55	20.50
6	2.50	3.55	6.50	35	17.00	18.05	21.00
7	3.00	4.05	7.00	36	17.50	18.55	21.50
8	3.50	4.55	7.50	37	18.00	19.05	22.00
9	4.00	5.05	8.00	38	18.50	19.55	22.50
10	4.50	5.55	8.50	39	19.00	20.05	23.00
11	5.00	6.05	9.00	40	19.50	20.55	23.50
12	5.50	6.55	9.50	41	20.00	21.05	24.00
13	6.00	7.05	10.00	42	20.50	21.55	24.50
14	6.50	7.55	10.50	43	21.00	22.05	25.00
15	7.00	8.05	11.00	44	21.50	22.55	25.50
16	7.50	8.55	11.50	45	22.00	23.05	26.00
17	8.00	9.05	12.00	46	22.50	23.55	26.50
18	8.50	9.55	12.50	47	23.00	24.05	27.00
19	9.00	10.05	13.00	48	23.50	24.55	27.50
20	9.50	10.55	13.50	49	24.00	25.05	28.00
21	10.00	11.05	14.00	50	24.50	25.55	28.50
22	10.50	11.55	14.50	51	25.00	26.05	29.00
23	11.00	12.05	15.00	52	25.50	26.55	29.50
24	11.50	12.55	15.50	53	26.00	27.05	30.00
25	12.00	13.05	16.00	54	26.50	27.55	30.50
26	12.50	13.55	16.50	55	27.00	28.05	31.00
27	13.00	14.05	17.00	56	27.50	28.55	31.50
28	13.50	14.55	17.50	57	28.00	29.05	32.00
29	14.00	15.05	18.00	58	28.50	29.55	32.50
30	14.50	15.55	18.50	59	29.00	30.05	33.00
31	15.00	16.05	19.00	60	29.50	30.55	33.50
32	15.50	16.55	19.50				

TOLERANCE X ±0.5    XX ±0.15 X ±0.25    XXX ±0.1 ANGLES    ±2°			<a href="http://www.i-ncp.com">www.i-ncp.com</a>		
	PART NO. IPFP05202 xx		TITLE: 0.5 FPC CONN ZIF SMT Easy-on		
	DRAWING NO. IPFP05202		H=2.0		
UNLESS OTHERWISE SPECIFIED		 SHEET 1 OF 1	UNITS mm	SCALE 1:1	REV. 01

单击下面可查看定价，库存，交付和生命周期等信息

[>>INCP](#)