

## 2.50mm Pitch Wire To Board Connector

### Specification

<b>Circuits</b>	02 - 15
<b>Pitch</b>	2.50mm
<b>Current Rating</b>	3A AC/DC
<b>Voltage Rating</b>	250V AC/DC
<b>Contact Resistance</b>	10mΩ MAX.
<b>Withstand Voltage</b>	800V AC/minute
<b>Insulation Resistance</b>	1,000MΩ MIN.
<b>Temperature Range</b>	-25°C - +85°C
<b>Applicable Wire Range</b>	AWG #22 - #28
<b>Applicable P.C.B Thickness</b>	1.6mm
<b>Applicable P.C.B Hole Dia.</b>	Ø 1.0mm ± 0.05

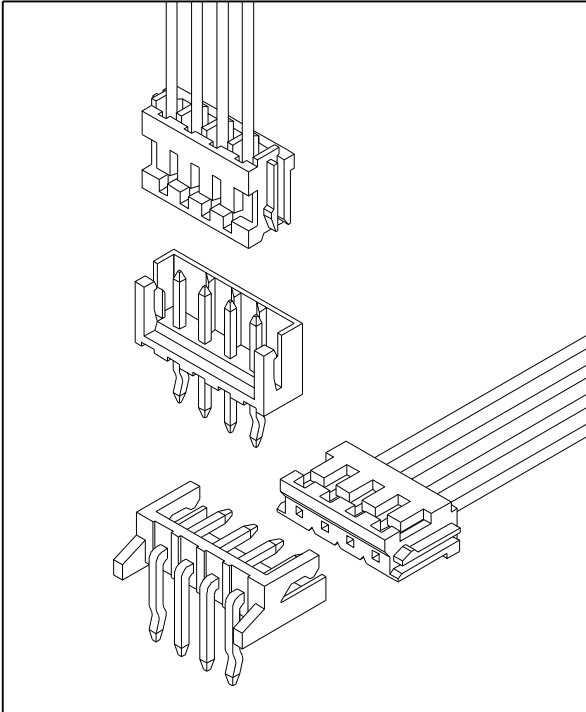

### Assembly Layout

Vertical Type

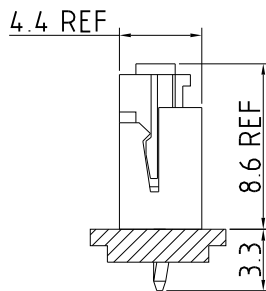

Right Angle Type

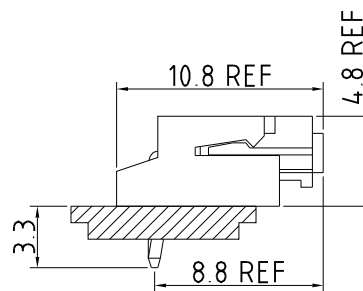

IPCW257 \* \*\* \* \* \* \* \*  
 ① ② ③ ④ ⑤ ⑥ ⑦ ⑧

- ① Series Type. IPCW257
- ② Connector Type.  
T: Terminal  
W: Wafer  
H: Housing
- ③ Pin code.  
Row  
Pin number of row

- ④ Material code.
- ⑤ Appearance code.
- ⑥ Internal code
- ⑦ Company code.

- ⑧ Other code.  
Wafer  
V: Vertical Type  
R: Right Angle  
S: Vertical SMT TYPE (02 - 08)  
T: Vertical SMT TYPE (09 - 16)  
M: Right Angle SMT TYPE

## 2.50mm Pitch Wire To Board Connector

Unit : mm

### Terminal

#### Features

Use with: IPCW257 Series Housing

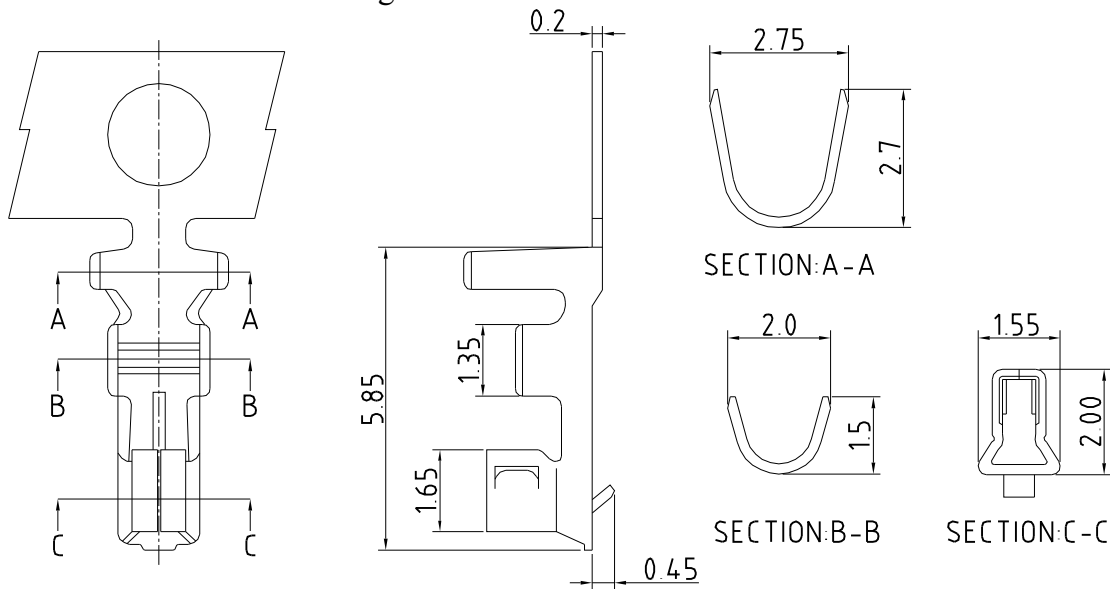

### CONTACT INFORMATION

Part No.	Wire Range	Insulation O.D.	Material	Finish	Q'ty/Reel
IPCW257T01*	AWG #22-#28	1.80mm(MAX.)	Brass	See note	10,000 pcs
IPCW257T02*			Phosphor bronze		

### Housing

#### Features

Available Number of Circuits: 02 - 15

Material: Regular Thermoplastic 94V-0

Use with: IPCW257 Crimp Terminal

Mates with :IPCW257 Series Wafer

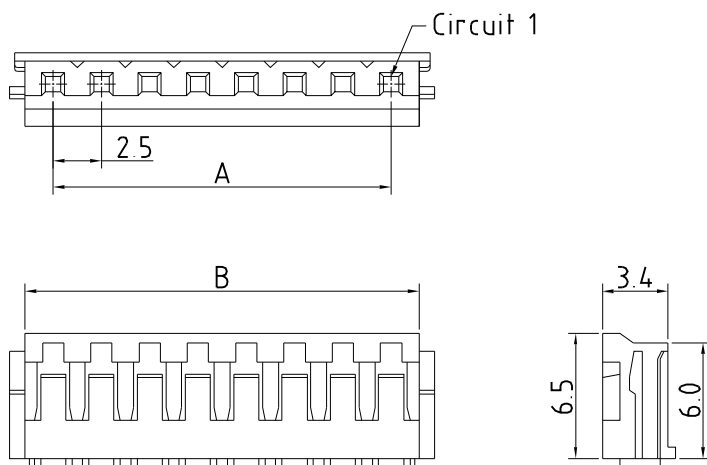

### Dimension and Order Information

Circuits	Part No.	DIM.(mm)	
		A	B
2	IPCW257H12*	2.50	5.40
3	IPCW257H13*	5.00	7.90
4	IPCW257H14*	7.50	10.40
5	IPCW257H15*	10.00	12.90
6	IPCW257H16*	12.50	15.40
7	IPCW257H17*	15.00	17.90
8	IPCW257H18*	17.50	20.40
9	IPCW257H19*	20.00	22.90
10	IPCW257H1A*	22.50	25.40
11	IPCW257H1B*	25.00	27.90
12	IPCW257H1C*	27.50	30.40
13	IPCW257H1D*	30.00	32.90
14	IPCW257H1E*	32.50	35.40
15	IPCW257H1F*	35.00	37.90

## 2.50mm Pitch Wire To Board Connector

**Unit : mm**

### Wafer Vertical

**Features**

**Available Number of Circuits : 02 - 15**

**Material : Regular Thermoplastic 94V-0**

**Contact: 0.64mm(.025") Copper Alloy, Tin-plated**

**Mates with : IPCW257 Series Housing**

Circuit 1

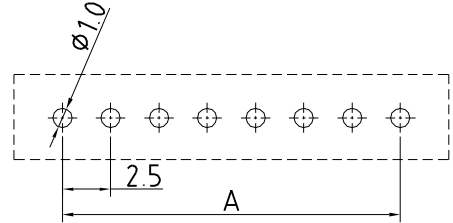
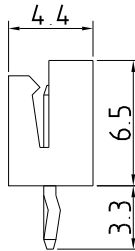
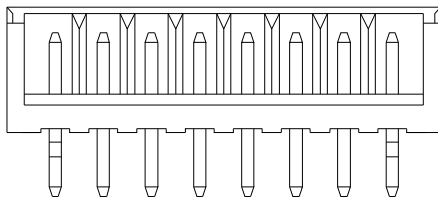
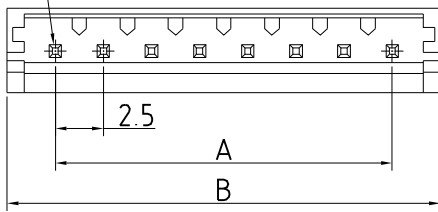

P.C.B LAYOUT

**Dimension and Order Information**

Circuits	Part No.	DIM.(mm)	
		A	B
2	IPCW257H12*V	2.50	7.50
3	IPCW257H13*V	5.00	10.00
4	IPCW257H14*V	7.50	12.50
5	IPCW257H15*V	10.00	15.00
6	IPCW257H16*V	12.50	17.50
7	IPCW257H17*V	15.00	20.00
8	IPCW257H18*V	17.50	22.50
9	IPCW257H19*V	20.00	25.00
10	IPCW257H1A*V	22.50	27.50
11	IPCW257H1B*V	25.00	30.00
12	IPCW257H1C*V	27.50	32.50
13	IPCW257H1D*V	30.00	35.00
14	IPCW257H1E*V	32.50	37.50
15	IPCW257H1F*V	35.00	40.00

### Wafer Right Angle

**Features**

**Available Number of Circuits : 02 - 15**

**Material : Regular Thermoplastic 94V-0**

**Contact: 0.64mm(.025") Copper Alloy, Tin-plated**

**Mates with : IPCW257 Series Housing**

Circuit 1

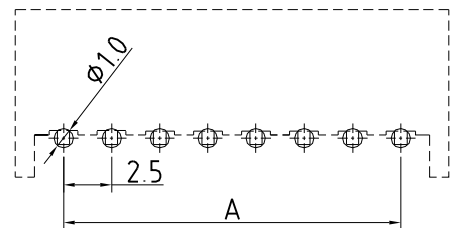
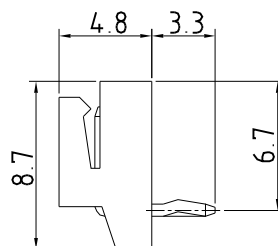
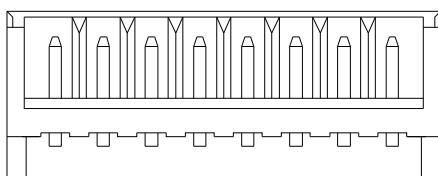
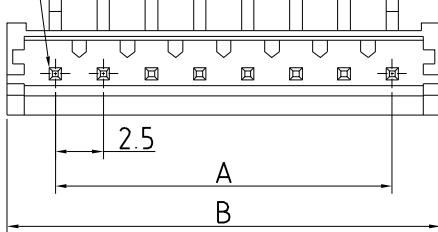

P.C.B LAYOUT

**Dimension and Order Information**

Circuits	Part No.	DIM.(mm)	
		A	B
2	IPCW257H12*R	2.50	7.50
3	IPCW257H13*R	5.00	10.00
4	IPCW257H14*R	7.50	12.50
5	IPCW257H15*R	10.00	15.00
6	IPCW257H16*R	12.50	17.50
7	IPCW257H17*R	15.00	20.00
8	IPCW257H18*R	17.50	22.50
9	IPCW257H19*R	20.00	25.00
10	IPCW257H1A*R	22.50	27.50
11	IPCW257H1B*R	25.00	30.00
12	IPCW257H1C*R	27.50	32.50
13	IPCW257H1D*R	30.00	35.00
14	IPCW257H1E*R	32.50	37.50
15	IPCW257H1F*R	35.00	40.00

单击下面可查看定价，库存，交付和生命周期等信息

[>>INCP](#)