

MOSFET

Metal Oxide Semiconductor Field Effect Transistor

CFDA Automotive

650V CoolMOS™ CFDA Power Transistor
IPW65R080CFDA

Data Sheet

Rev. 2.1
Final

Automotive

1 Description

CoolMOS™ is a revolutionary technology for high voltage power MOSFETs, designed according to the superjunction (SJ) principle and pioneered by Infineon Technologies. 650V CoolMOS™ CFDA series combines the experience of the leading SJ MOSFET supplier with high class innovation. The resulting devices provide all benefits of a fast switching SJ MOSFET while offering an extremely fast and robust body diode. This combination of extremely low switching, commutation and conduction losses together with highest robustness make especially resonant switching applications more reliable, more efficient, lighter, and cooler.

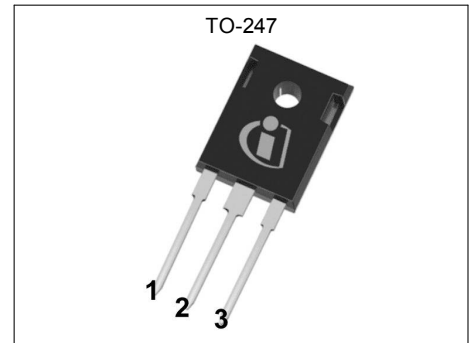

Features

- Ultra-fast body diode
- Very high commutation ruggedness
- Extremely low losses due to very low FOM $R_{ds(on)} \cdot Q_g$ and E_{oss}
- Easy to use/drive
- Qualified according to AEC Q101
- Green package (RoHS compliant), Pb-free plating, halogen free for mold compound

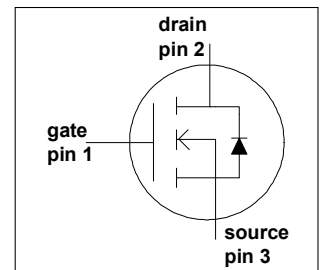

Applications

650V CoolMOS™ CFDA is designed for switching applications.



Table 1 Key Performance Parameters

| Parameter | Value | Unit |
|--------------------|-------|------------|
| V_{DS} | 650 | V |
| $R_{DS(on),max}$ | 0.08 | Ω |
| Q_g,typ | 161 | nC |
| $I_D,pulse$ | 137 | A |
| $E_{oss @ 400V}$ | 12.5 | μJ |
| Body diode di/dt | 900 | A/ μs |
| Q_{rr} | 1.2 | μC |
| t_{rr} | 180 | ns |
| I_{rrm} | 10 | A |

| Type / Ordering Code | Package | Marking | Related Links |
|----------------------|-----------|----------|---------------|
| IPW65R080CFDA | PG-TO 247 | 65F6080A | - |



Table of Contents

| | |
|---|----|
| Description | 2 |
| Table of Contents | 3 |
| Maximum ratings | 4 |
| Thermal characteristics | 5 |
| Electrical characteristics | 6 |
| Electrical characteristics diagrams | 8 |
| Test Circuits | 12 |
| Package Outlines | 13 |
| Revision History | 14 |
| Disclaimer | 14 |

2 Maximum ratings

at $T_j = 25^\circ\text{C}$, unless otherwise specified

Table 2 Maximum ratings

| Parameter | Symbol | Values | | | Unit | Note / Test Condition |
|---|----------------|--------|------|------|------------------|--|
| | | Min. | Typ. | Max. | | |
| Continuous drain current ¹⁾ | I_D | | | 43.3 | A | $T_C = 25^\circ\text{C}$ |
| | | | | 27.4 | | $T_C = 100^\circ\text{C}$ |
| Pulsed drain current ²⁾ | $I_{D,pulse}$ | | | 137 | A | $T_C = 25^\circ\text{C}$ |
| Avalanche energy, single pulse | E_{AS} | | | 1160 | mJ | $I_D = 8.7\text{A}$, $V_{DD} = 50\text{V}$ (see table 18) |
| Avalanche energy, repetitive | E_{AR} | | | 1.76 | mJ | $I_D = 8.7\text{A}$, $V_{DD} = 50\text{V}$ |
| Avalanche current, repetitive | I_{AR} | | | 8.7 | A | |
| MOSFET dv/dt ruggedness | dv/dt | | | 50 | V/ns | $V_{DS} = 0 \dots 400\text{V}$ |
| Gate source voltage | V_{GS} | -20 | | 20 | V | static |
| | | -30 | | 30 | | AC ($f > 1\text{Hz}$) |
| Power dissipation (non FullPAK) TO-247 | P_{Tot} | | | 391 | W | $T_C = 25^\circ\text{C}$ |
| Operating and storage temperature | T_j, T_{stg} | -40 | | 150 | $^\circ\text{C}$ | |
| Mounting torque (non FullPAK) TO-247 | | | | 60 | Ncm | M3 and M3.5 screws |
| Continuous diode forward current | I_S | | | 43.3 | A | $T_C = 25^\circ\text{C}$ |
| Diode pulse current | $I_{S,pulse}$ | | | 140 | A | $T_C = 25^\circ\text{C}$ |
| Reverse diode dv/dt ³⁾ | dv/dt | | | 50 | V/ns | $V_{DS} = 0 \dots 400\text{V}$, $I_{SD} \leq I_D$, $T_j = 25^\circ\text{C}$ (see table 16) |
| Maximum diode commutation speed | di_f/dt | | | 900 | A/ μs | |

¹⁾ Limited by $T_{j,max}$.

²⁾ Pulse width t_p limited by $T_{j,max}$

³⁾ Identical low side and high side switch with identical R_G

3 Thermal characteristics

Table 3 Thermal characteristics TO-247

| Parameter | Symbol | Values | | | Unit | Note / Test Condition |
|--|------------|--------|------|------|------|--------------------------------------|
| | | Min. | Typ. | Max. | | |
| Thermal resistance, junction - case | R_{thJC} | | | 0.32 | K/W | |
| Thermal resistance, junction - ambient | R_{thJA} | | | 62 | K/W | leaded |
| Soldering temperature, wavesoldering only allowed at leads | T_{sold} | | | 260 | °C | 1.6 mm (0.063 in.) from case for 10s |

4 Electrical characteristics

at $T_j = 25^\circ\text{C}$, unless otherwise specified

Table 4 Static characteristics

| Parameter | Symbol | Values | | | Unit | Note / Test Condition |
|--|---------------|--------|-------|------|----------|---|
| | | Min. | Typ. | Max. | | |
| Drain-source breakdown voltage ¹⁾ | $V_{(BR)DSS}$ | 650 | | | V | $V_{GS} = 0V, I_D = 1mA$ |
| Gate threshold voltage | $V_{GS(th)}$ | 3.5 | 4 | 4.5 | V | $V_{DS} = V_{GS}, I_D = 1.76mA$ |
| Zero gate voltage drain current | I_{DSS} | | | 2 | μA | $V_{DS} = 650V, V_{GS} = 0V, T_j = 25^\circ C$ |
| | | | 500 | | | $V_{DS} = 650V, V_{GS} = 0V, T_j = 150^\circ C$ |
| Gate-source leakage current | I_{GSS} | | | 100 | nA | $V_{GS} = 20V, V_{DS} = 0V$ |
| Drain-source on-state resistance | $R_{DS(on)}$ | | 0.072 | 0.08 | Ω | $V_{GS} = 10V, I_D = 17.6A, T_j = 25^\circ C$ |
| | | | 0.19 | | | $V_{GS} = 10V, I_D = 17.6A, T_j = 150^\circ C$ |
| Gate resistance | R_G | | 0.75 | | Ω | $f = 1MHz, \text{open drain}$ |

Table 5 Dynamic characteristics

| Parameter | Symbol | Values | | | Unit | Note / Test Condition |
|--|--------------|--------|------|------|------|---|
| | | Min. | Typ. | Max. | | |
| Input capacitance | C_{iss} | | 4440 | | pF | $V_{GS} = 0V, V_{DS} = 100V, f = 1MHz$ |
| Output capacitance | C_{oss} | | 210 | | pF | |
| Effective output capacitance, energy related ²⁾ | $C_{o(er)}$ | | 160 | | pF | $V_{GS} = 0V, V_{DS} = 0 \dots 400V$ |
| Effective output capacitance, time related ³⁾ | $C_{o(tr)}$ | | 754 | | pF | $I_D = \text{constant}, V_{GS} = 0V, V_{DS} = 0 \dots 400V$ |
| Turn-on delay time | $t_{d(on)}$ | | 20 | | ns | $V_{DD} = 480V, V_{GS} = 13V, I_D = 26.3A, R_G = 1.8\Omega$ (see table 17) |
| Rise time | t_r | | 18 | | ns | |
| Turn-off delay time | $t_{d(off)}$ | | 85 | | ns | |
| Fall time | t_f | | 6 | | ns | |

Table 6 Gate charge characteristics

| Parameter | Symbol | Values | | | Unit | Note / Test Condition |
|-----------------------|---------------|--------|------|------|------|--|
| | | Min. | Typ. | Max. | | |
| Gate to source charge | Q_{gs} | | 28 | | nC | $V_{DD} = 480V, I_D = 26.3A, V_{GS} = 0 \text{ to } 10V$ |
| Gate to drain charge | Q_{gd} | | 87 | | nC | |
| Gate charge total | Q_g | | 161 | | nC | |
| Gate plateau voltage | $V_{plateau}$ | | 6.4 | | V | |

¹⁾ For applications with applied blocking voltage > 65% of the specified blocking voltage, we recommend to evaluate the impact of the cosmic radiation effect in early design phase. For assessment please contact local Infineon sales office.

²⁾ $C_{o(er)}$ is a fixed capacitance that gives the same stored energy as C_{oss} while V_{DS} is rising from 0 to 400V

³⁾ $C_{o(tr)}$ is a fixed capacitance that gives the same charging time as C_{oss} while V_{DS} is rising from 0 to 400V

Table 7 Reverse diode characteristics

| Parameter | Symbol | Values | | | Unit | Note / Test Condition |
|-------------------------------|-----------|--------|------|------|---------|--|
| | | Min. | Typ. | Max. | | |
| Diode forward voltage | V_{SD} | | 0.9 | | V | $V_{GS} = 0V, I_F = 26.3A, T_j = 25^\circ C$ |
| Reverse recovery time | t_{rr} | | 180 | | ns | $V_R = 400V, I_F = 26.3A,$ $di_F/dt = 100A/\mu s$ (see table 16) |
| Reverse recovery charge | Q_{rr} | | 1.2 | | μC | |
| Peak reverse recovery current | I_{rrm} | | 10 | | A | |

5 Electrical characteristics diagrams

Table 8

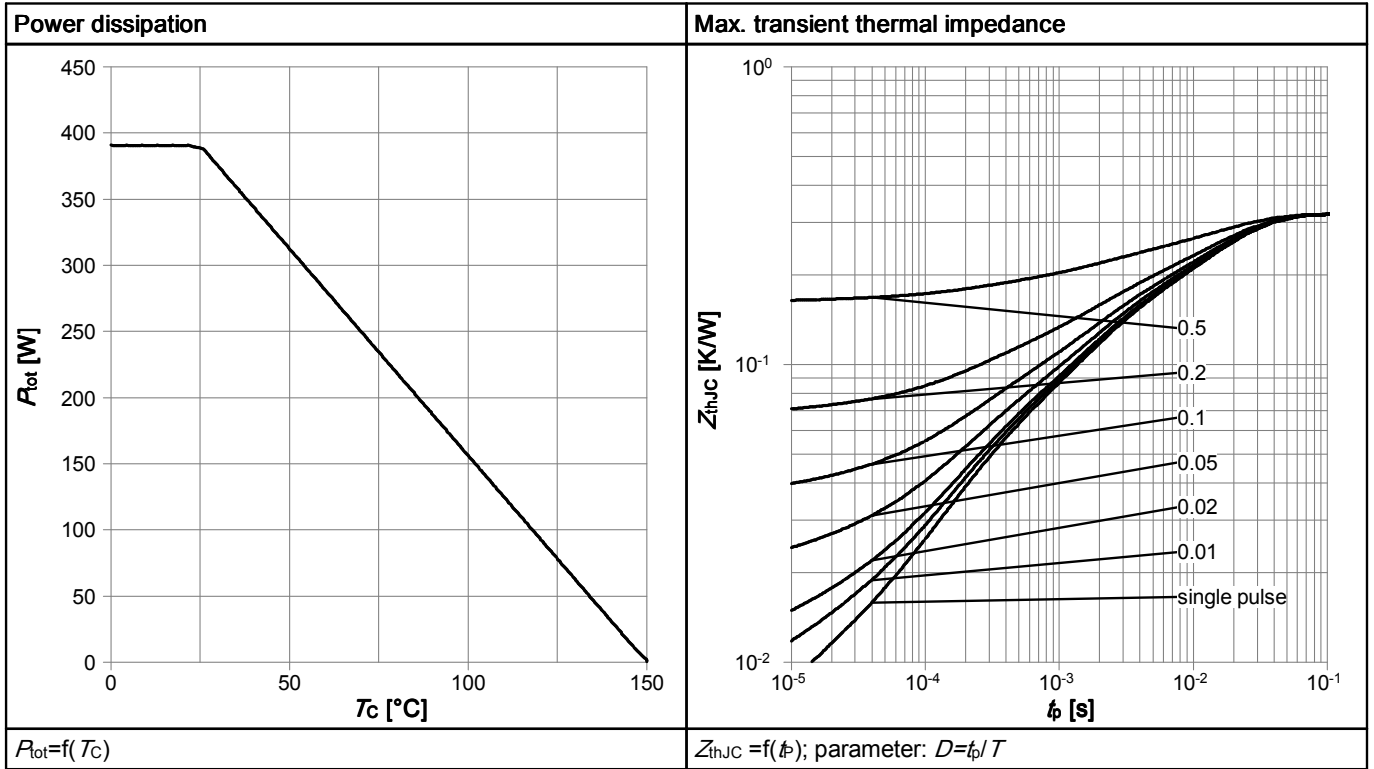

Table 9

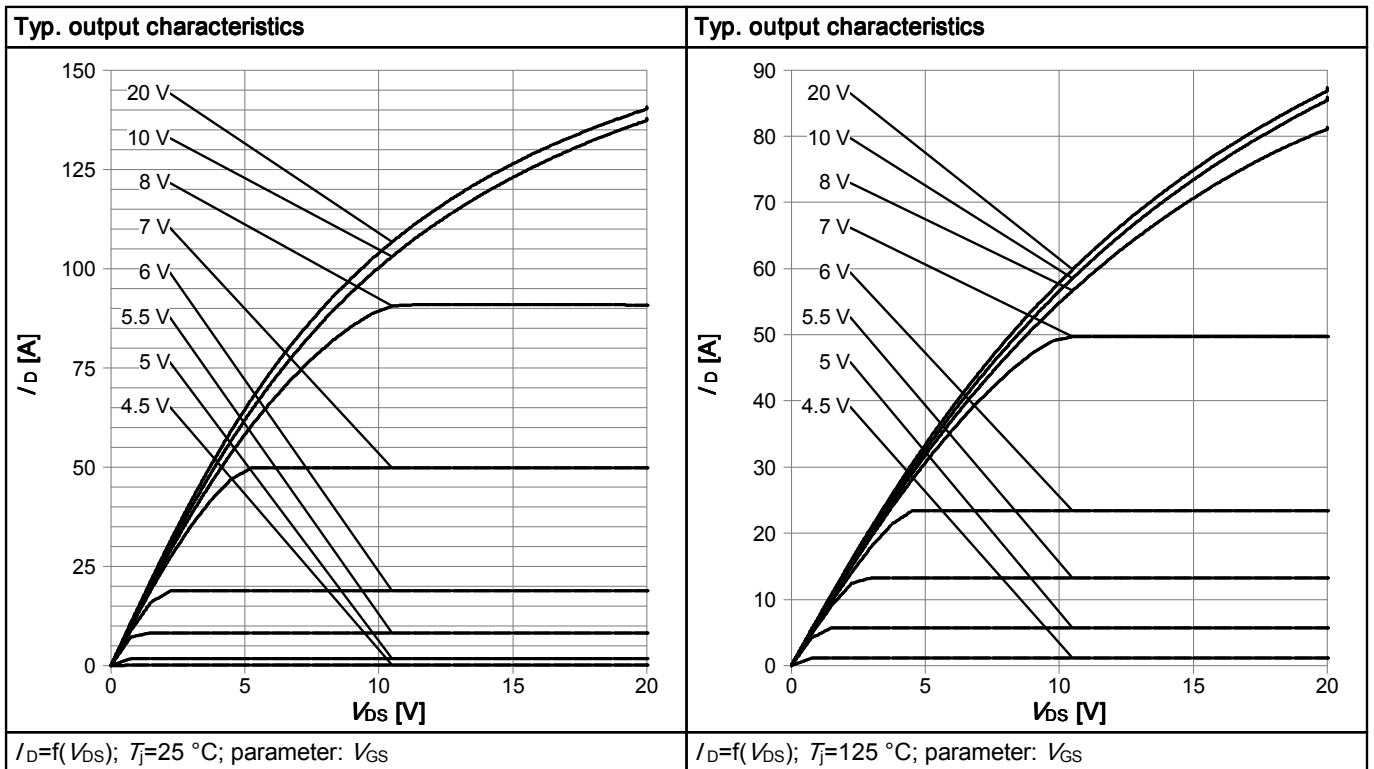

Table 10

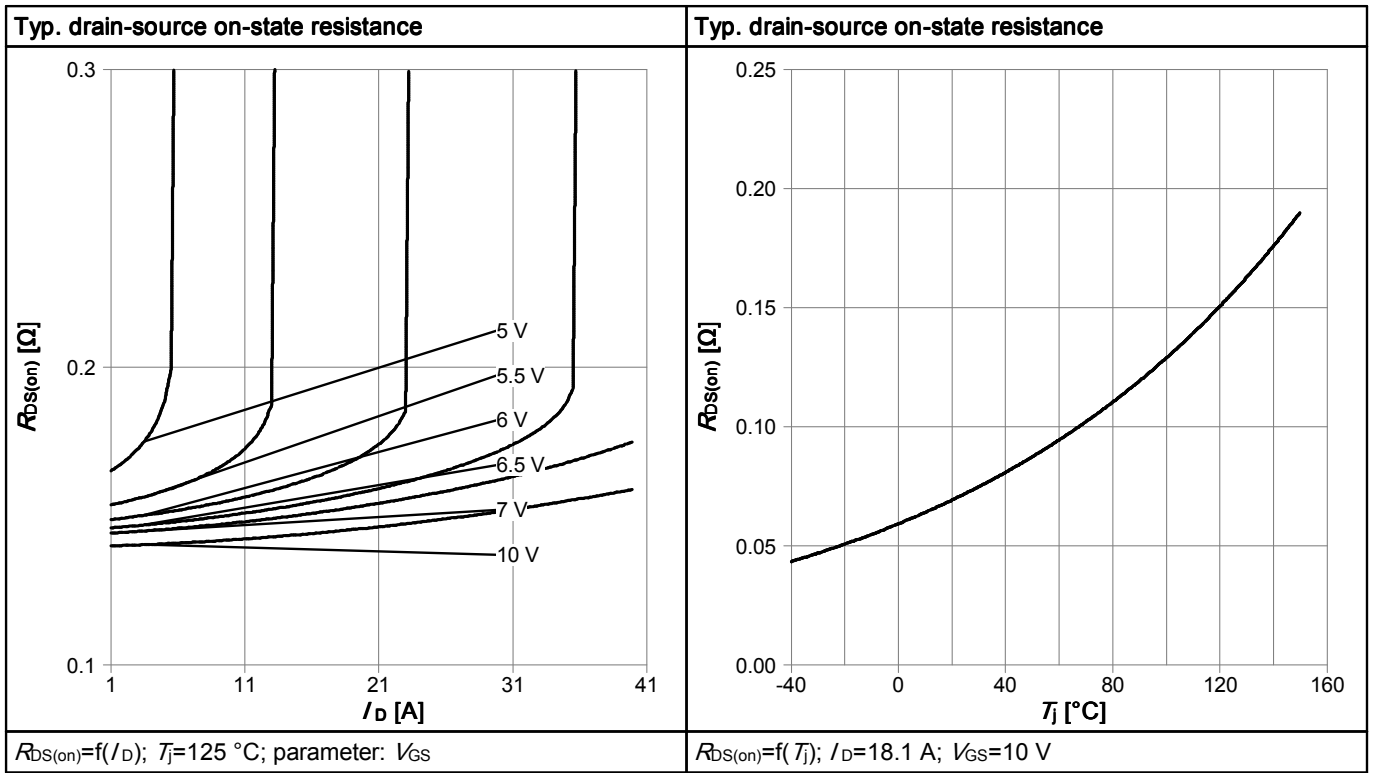

Table 11

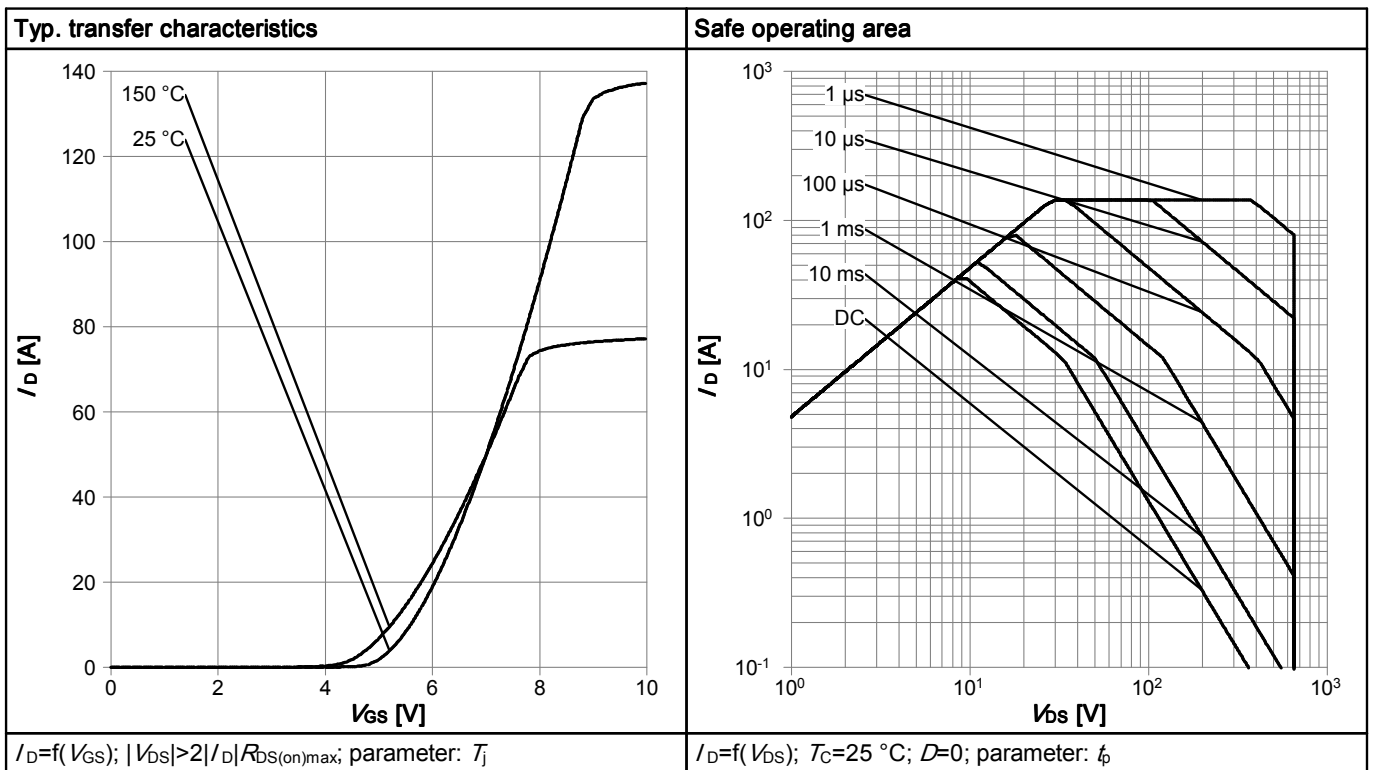

Table 12

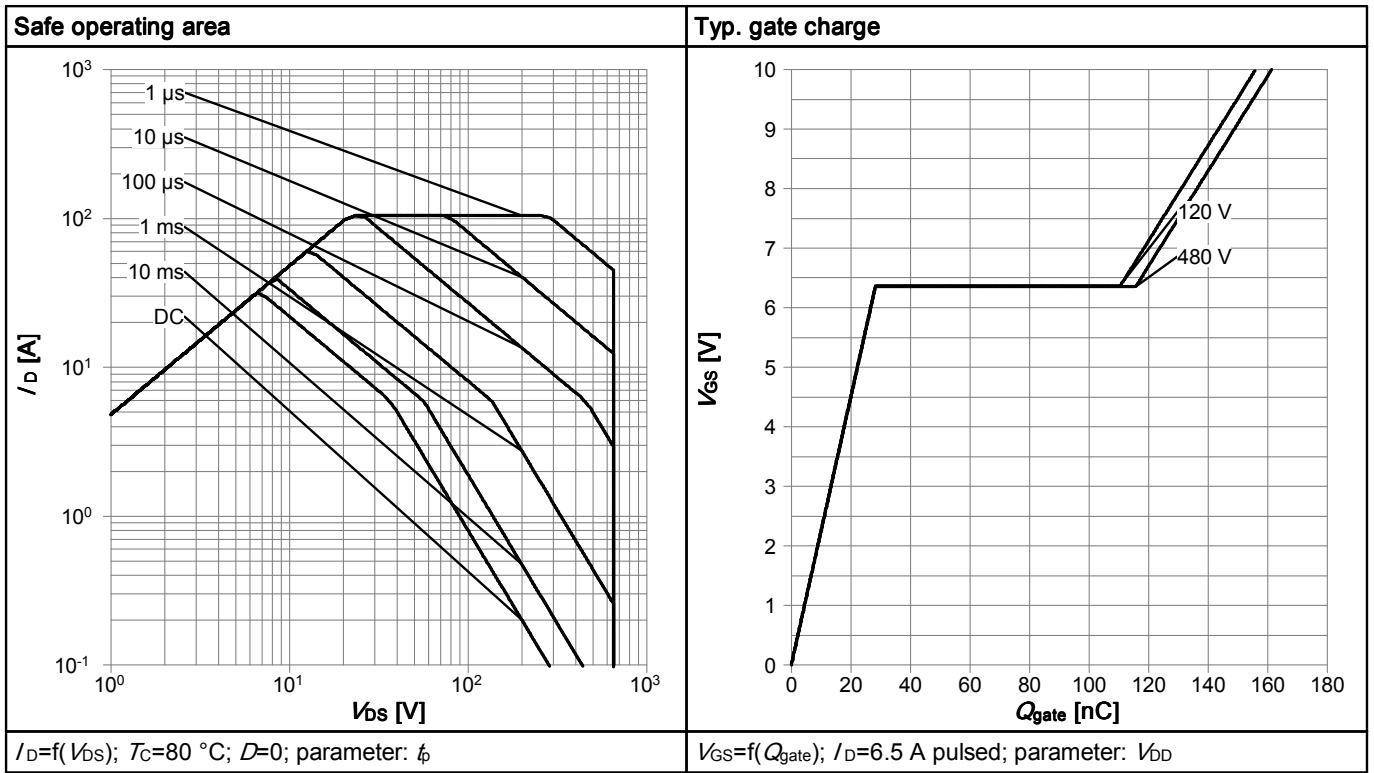

Table 13

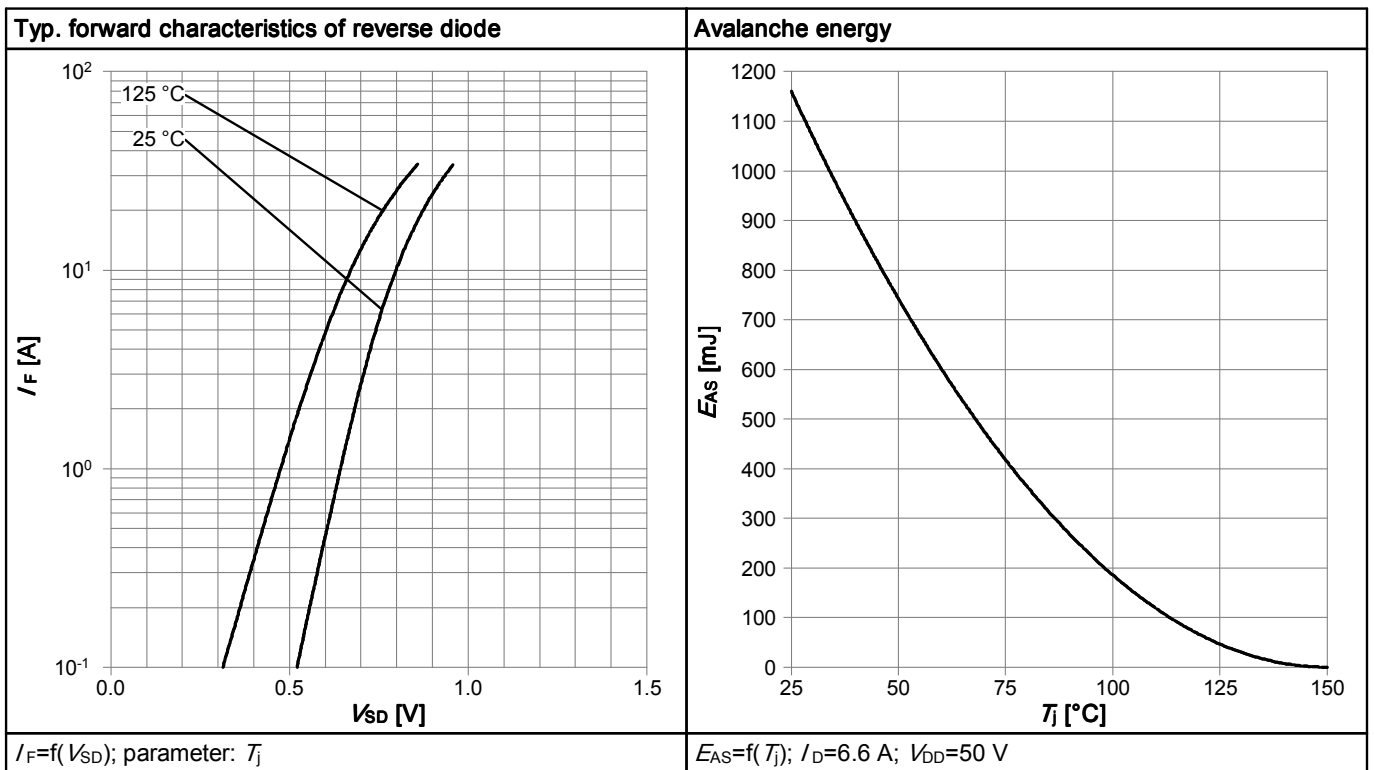

Table 14

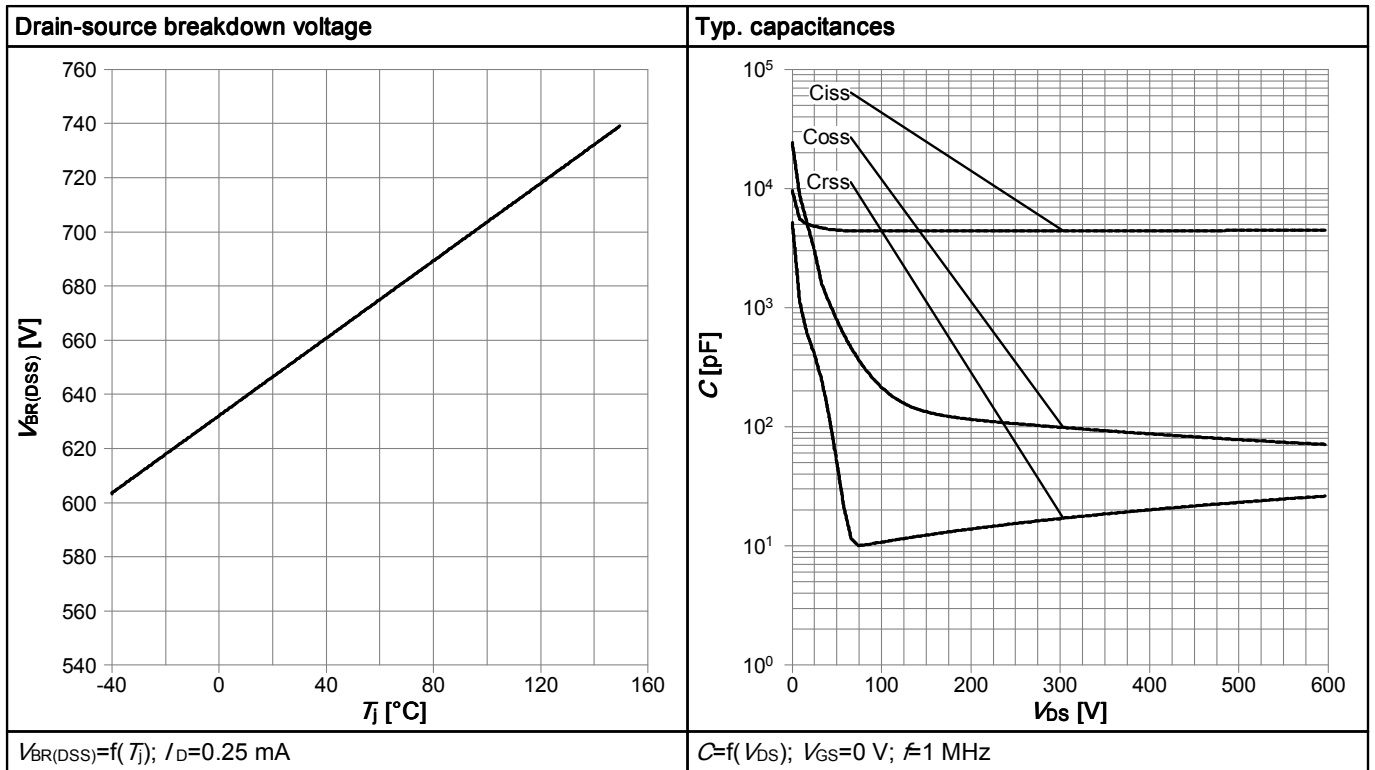
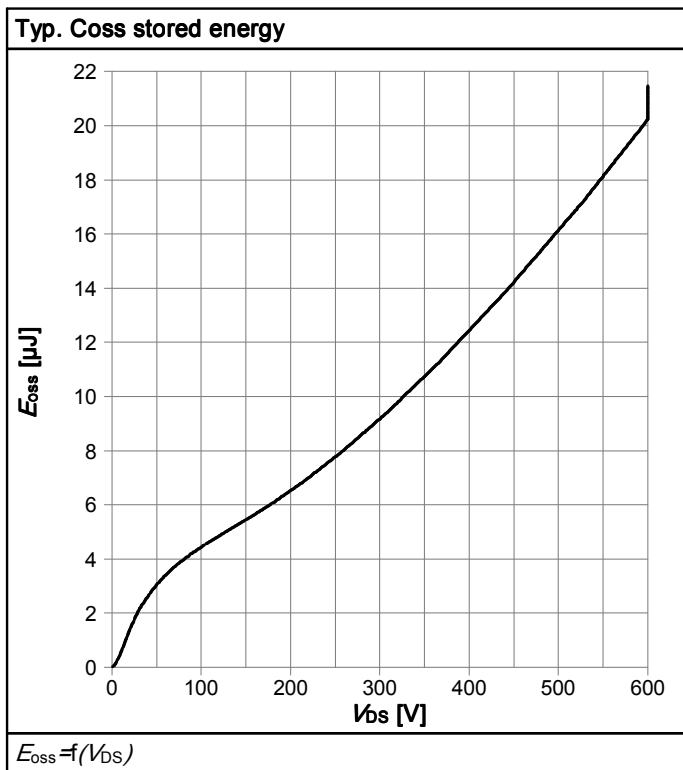

Table 15



6 Test Circuits

Table 16 Diode characteristics

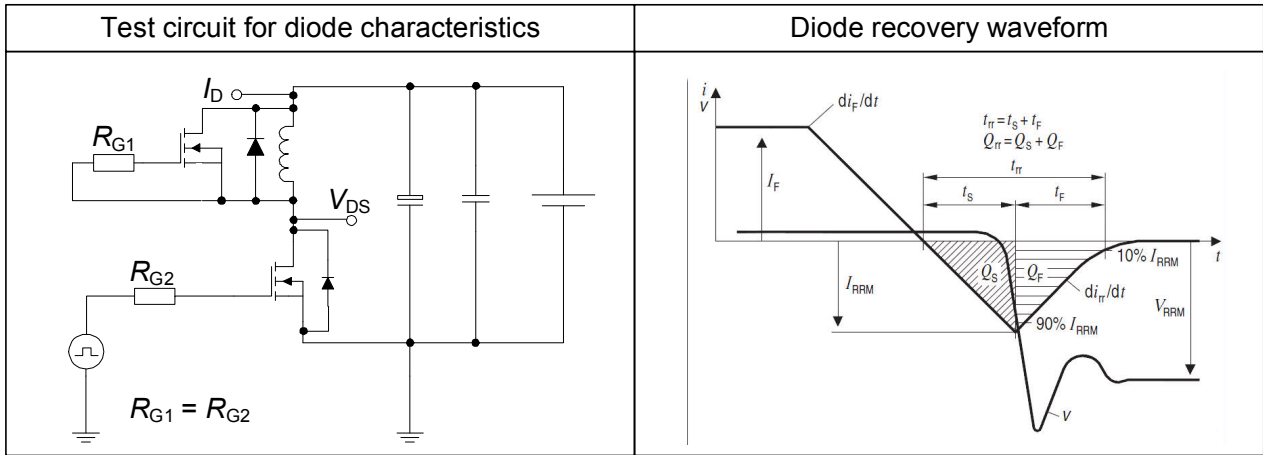

Table 17 Switching times

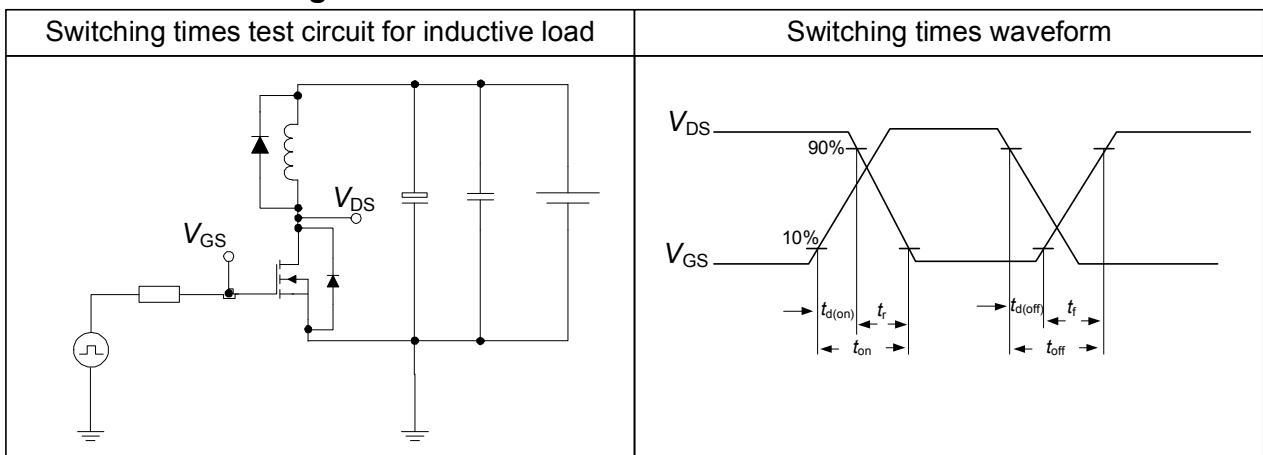
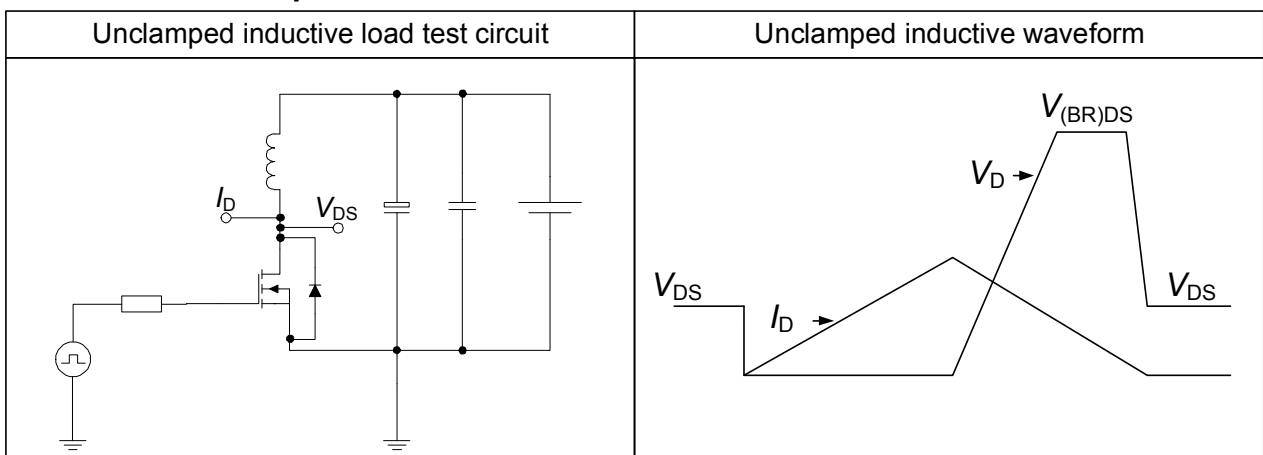

Table 18 Unclamped inductive



7 Package Outlines

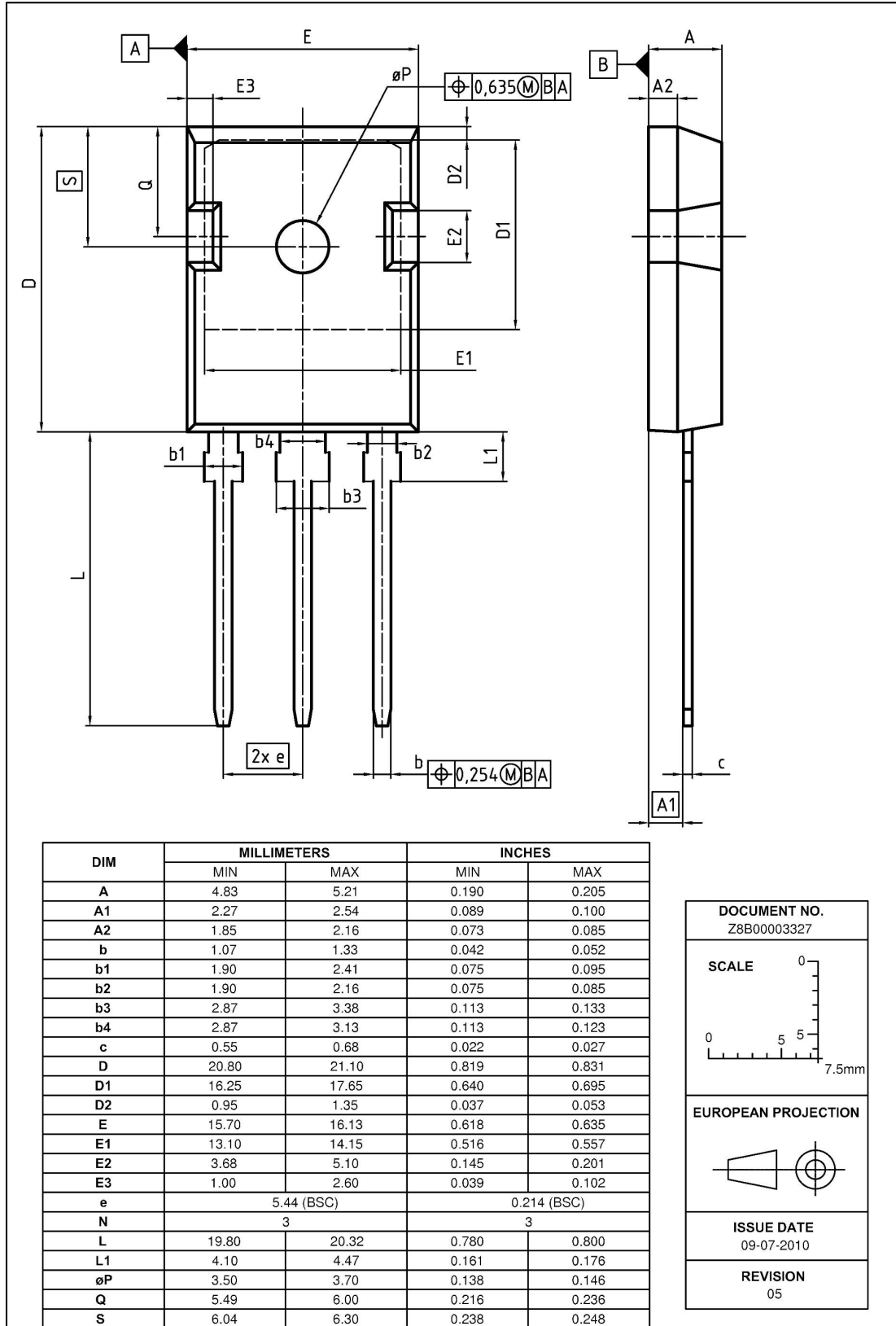

Figure 1 Outline PG-TO 247, dimensions in mm/inches

Revision History

IPW65R080CFDA

Revision: 2012-04-02, Rev. 2.1

Previous Revision

| Revision | Date | Subjects (major changes since last revision) |
|----------|------------|--|
| 2.0 | 2012-03-28 | Final datasheet |
| 2.1 | 2012-04-02 | - |

Disclaimer ATV

We Listen to Your Comments

Any information within this document that you feel is wrong, unclear or missing at all? Your feedback will help us to continuously improve the quality of this document. Please send your proposal (including a reference to this document) to: erratum@infineon.com

Edition 2011-09-30**Published by****Infineon Technologies AG****81726 München, Germany****© 2011 Infineon Technologies AG****All Rights Reserved.**

Legal Disclaimer

The information given in this document shall in no event be regarded as a guarantee of conditions or characteristics ("Beschaffenheitsgarantie"). With respect to any examples or hints given herein, any typical values stated herein and/or any information regarding the application of the device, Infineon Technologies hereby disclaims any and all warranties and liabilities of any kind, including without limitation warranties of non-infringement of intellectual property rights of any third party.

Information

For further information on technology, delivery terms and conditions and prices please contact your nearest Infineon Technologies Office (www.infineon.com).

Warnings

Due to technical requirements components may contain dangerous substances. For information on the types in question please contact your nearest Infineon Technologies Office.

Infineon Technologies Components may only be used in life-support devices or systems with the express written approval of Infineon Technologies, if a failure of such components can reasonably be expected to cause the failure of that life-support device or system, or to affect the safety or effectiveness of that device or system. Life support devices or systems are intended to be implanted in the human body, or to support and/or maintain and sustain and/or protect human life.

If they fail, it is reasonable to assume that the health of the user or other persons may be endangered.

单击下面可查看定价，库存，交付和生命周期等信息

[>>Infineon\(英飞凌\)](#)