

IMZ120R060M1H

CoolSiC™ 1200V SiC Trench MOSFET Silicon Carbide MOSFET

Features

- Very low switching losses
- Threshold-free on state characteristic
- Benchmark gate threshold voltage, $V_{GS(th)} = 4.5V$
- 0V turn-off gate voltage for easy and simple gate drive
- Fully controllable dV/dt
- Robust body diode for hard commutation
- Temperature independent turn-off switching losses
- Sense pin for optimized switching performance

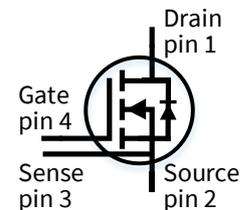

Benefits

- Efficiency improvement
- Enabling higher frequency
- Increased power density
- Cooling effort reduction
- Reduction of system complexity and cost

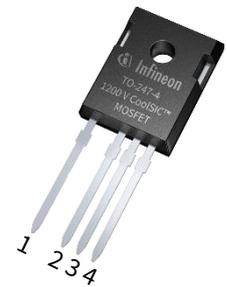

Potential applications

- Energy generation
 - Solar string inverter and solar optimizer
- Industrial power supplies
 - Industrial UPS
 - Industrial SMPS
- Infrastructure – Charge
 - Charger



Product validation

Qualified for industrial applications according to the relevant tests of JEDEC 47/20/22

Note: *the source and sense pins are not exchangeable, their exchange might lead to malfunction*

Table 1 Key Performance and Package Parameters

Type	V_{DS}	I_D <small>$T_C = 25^\circ C, R_{th(j-c,max)}$</small>	$R_{DS(on)}$ <small>$T_{vj} = 25^\circ C, I_D = 13A, V_{GS} = 18V$</small>	$T_{vj,max}$	Marking	Package
IMZ120R060M1H	1200V	36A	60m Ω	175 $^\circ C$	12M1H060	PG-TO247-4

Table of contents

Features	1
Benefits	1
Potential applications	1
Product validation	1
Table of contents	2
1 Maximum ratings	3
2 Thermal resistances	4
3 Electrical Characteristics	5
3.1 Static characteristics	5
3.2 Dynamic characteristics	6
3.3 Switching characteristics	7
4 Electrical characteristic diagrams	8
5 Package drawing	14
6 Test conditions	15
Revision history	16

Maximum ratings

1 Maximum ratings

For optimum lifetime and reliability, Infineon recommends operating conditions that do not exceed 80% of the maximum ratings stated in this datasheet.

Table 2 Maximum ratings

Parameter	Symbol	Value	Unit
Drain-source voltage, $T_{vj} \geq 25^\circ\text{C}$	V_{DSS}	1200	V
DC drain current for $R_{th(j-c,max)}$, limited by $T_{vj,max}$, $V_{GS} = 18\text{V}$, $T_C = 25^\circ\text{C}$	I_D	36	A
$T_C = 100^\circ\text{C}$		26	
Pulsed drain current, t_p limited by $T_{vj,max}$, $V_{GS} = 18\text{V}$	$I_{D,pulse}^1$	76	A
DC body diode forward current for $R_{th(j-c,max)}$, limited by $T_{vj,max}$, $V_{GS} = 0\text{V}$	I_{SD}	36	A
$T_C = 100^\circ\text{C}$		22	
Pulsed body diode current, t_p limited by $T_{vj,max}$	$I_{SD,pulse}^1$	76	A
Gate-source voltage ²			
Max transient voltage, < 1% duty cycle	V_{GS}	-7... 23	V
Recommended turn-on gate voltage	$V_{GS,on}$	15... 18	
Recommended turn-off gate voltage	$V_{GS,off}$	0	
Short-circuit withstand time $V_{DD} = 800\text{V}$, $V_{DS,peak} < 1200\text{V}$, $V_{GS,on} = 15\text{V}$, $T_{j,start} = 25^\circ\text{C}$	t_{SC}	3	μs
Power dissipation, limited by $T_{vj,max}$	P_{tot}	150	W
$T_C = 100^\circ\text{C}$		75	
Virtual junction temperature	T_{vj}	-55... 175	$^\circ\text{C}$
Storage temperature	T_{stg}	-55... 150	$^\circ\text{C}$
Soldering temperature, wave soldering only allowed at leads, 1.6mm (0.063 in.) from case for 10 s	T_{sold}	260	$^\circ\text{C}$
Mounting torque, M3 screw Maximum of mounting processes: 3	M	0.6	Nm

¹ verified by design

² **Important note:** The selection of positive and negative gate-source voltages impacts the long-term behavior of the device. The design guidelines described in [Application Note AN2018-09](#) must be considered to ensure sound operation of the device over the planned lifetime.

Thermal resistances

2 Thermal resistances

Table 3

Parameter	Symbol	Conditions	Value			Unit
			min.	typ.	max.	
MOSFET/body diode thermal resistance, junction – case	$R_{th(j-c)}$		-	0.8	1	K/W
Thermal resistance, junction – ambient	$R_{th(j-a)}$	leaded	-	-	62	K/W

Electrical Characteristics

3 Electrical Characteristics

3.1 Static characteristics

Table 4 Static characteristics (at $T_{vj} = 25^{\circ}\text{C}$, unless otherwise specified)

Parameter	Symbol	Conditions	Value			Unit
			min.	typ.	max.	
Drain-source on-state resistance	$R_{DS(on)}$	$V_{GS} = 18\text{V}, I_D = 13\text{A},$ $T_{vj} = 25^{\circ}\text{C}$	-	60	83	mΩ
		$T_{vj} = 100^{\circ}\text{C}$	-	76	-	
		$T_{vj} = 175^{\circ}\text{C}$	-	113	-	
		$V_{GS} = 15\text{V}, I_D = 13\text{A},$ $T_{vj} = 25^{\circ}\text{C}$	-	80	106	
Body diode forward voltage	V_{SD}	$V_{GS} = 0\text{V}, I_{SD} = 13\text{A}$ $T_{vj} = 25^{\circ}\text{C}$	-	4.1	5.2	V
		$T_{vj} = 100^{\circ}\text{C}$	-	4.0	-	
		$T_{vj} = 175^{\circ}\text{C}$	-	3.9	-	
Gate-source threshold voltage	$V_{GS(th)}$	<i>(tested after 1 ms pulse at</i> $V_{GS} = 20\text{V})$ $I_D = 5.6\text{mA}, V_{DS} = V_{GS}$ $T_{vj} = 25^{\circ}\text{C}$	3.5	4.5	5.7	V
		$T_{vj} = 175^{\circ}\text{C}$	-	3.6	-	
Zero gate voltage drain current	I_{DSS}	$V_{GS} = 0\text{V}, V_{DS} = 1200\text{V}$ $T_{vj} = 25^{\circ}\text{C}$	-	0.6	180	μA
		$T_{vj} = 175^{\circ}\text{C}$	-	1.9	-	
Gate-source leakage current	I_{GSS}	$V_{GS} = 23\text{V}, V_{DS} = 0\text{V}$	-	-	100	nA
		$V_{GS} = -7\text{V}, V_{DS} = 0\text{V}$	-	-	-100	nA
Transconductance	g_{fs}	$V_{DS} = 20\text{V}, I_D = 13\text{A}$	-	7	-	S
Internal gate resistance	$R_{G,int}$	$f = 1\text{MHz}, V_{AC} = 25\text{mV}$	-	6	-	Ω

Electrical Characteristics

3.2 Dynamic characteristics

Table 5 Dynamic characteristics (at $T_{vj} = 25^{\circ}\text{C}$, unless otherwise specified)

Parameter	Symbol	Conditions	Value			Unit
			min.	typ.	max.	
Input capacitance	C_{iss}	$V_{DD} = 800\text{V}, V_{GS} = 0\text{V},$ $f = 1\text{MHz}, V_{AC} = 25\text{mV}$	-	1060	-	pF
Output capacitance	C_{oss}		-	58	-	
Reverse capacitance	C_{rss}		-	6.5	-	
C_{oss} stored energy	E_{oss}		-	22	-	μJ
Total gate charge	Q_G	$V_{DD} = 800\text{V}, I_D = 13\text{A},$ $V_{GS} = 0/18\text{V}, \text{turn-on pulse}$	-	31	-	nC
Gate to source charge	$Q_{GS,pl}$		-	9	-	
Gate to drain charge	Q_{GD}		-	7	-	

Electrical Characteristics

3.3 Switching characteristics

Table 6 Switching characteristics, Inductive load ⁴

Parameter	Symbol	Conditions	Value			Unit
			min.	typ.	max.	
MOSFET Characteristics, $T_{vj} = 25^{\circ}\text{C}$						
Turn-on delay time	$t_{d(on)}$	$V_{DD} = 800\text{V}, I_D = 13\text{A},$ $V_{GS} = 0/18\text{V}, R_{G,ext} = 2\Omega,$ $L_{\sigma} = 40\text{nH},$ diode: body diode at $V_{GS} = 0\text{V}$ see Fig. E	-	6	-	ns
Rise time	t_r		-	5	-	
Turn-off delay time	$t_{d(off)}$		-	12.7	-	
Fall time	t_f		-	10.8	-	
Turn-on energy	E_{on}		-	135	-	μJ
Turn-off energy	E_{off}		-	31	-	
Total switching energy	E_{tot}	-	166	-		
Body Diode Characteristics, $T_{vj} = 25^{\circ}\text{C}$						
Diode reverse recovery charge	Q_{rr}	$V_{DD} = 800\text{V}, I_{SD} = 13\text{A},$ V_{GS} at diode = $0\text{V},$ $di_f/dt = 1000\text{A}/\mu\text{s},$ Q_{rr} includes also $Q_C,$ see Fig. C	-	180	-	nC
Diode peak reverse recovery current	I_{rrm}		-	5	-	A

MOSFET Characteristics, $T_{vj} = 175^{\circ}\text{C}$

Turn-on delay time	$t_{d(on)}$	$V_{DD} = 800\text{V}, I_D = 13\text{A},$ $V_{GS} = 0/18\text{V}, R_{G,ext} = 2\Omega,$ $L_{\sigma} = 40\text{nH},$ diode: body diode at $V_{GS} = 0\text{V}$ see Fig. E	-	6	-	ns
Rise time	t_r		-	11.6	-	
Turn-off delay time	$t_{d(off)}$		-	12.7	-	
Fall time	t_f		-	10.8	-	
Turn-on energy	E_{on}		-	196	-	μJ
Turn-off energy	E_{off}		-	36	-	
Total switching energy	E_{tot}	-	232	-		
Body Diode Characteristics, $T_{vj} = 175^{\circ}\text{C}$						
Diode reverse recovery charge	Q_{rr}	$V_{DD} = 800\text{V}, I_{SD} = 13\text{A},$ V_{GS} at diode = $0\text{V},$ $di_f/dt = 1000\text{A}/\mu\text{s},$ Q_{rr} includes also $Q_C,$ see Fig. C	-	225	-	nC
Diode peak reverse recovery current	I_{rrm}		-	7	-	A

⁴ The chip technology was characterized up to 200 kV/ μs . The measured dV/dt was limited by measurement test setup and package.

4 Electrical characteristic diagrams

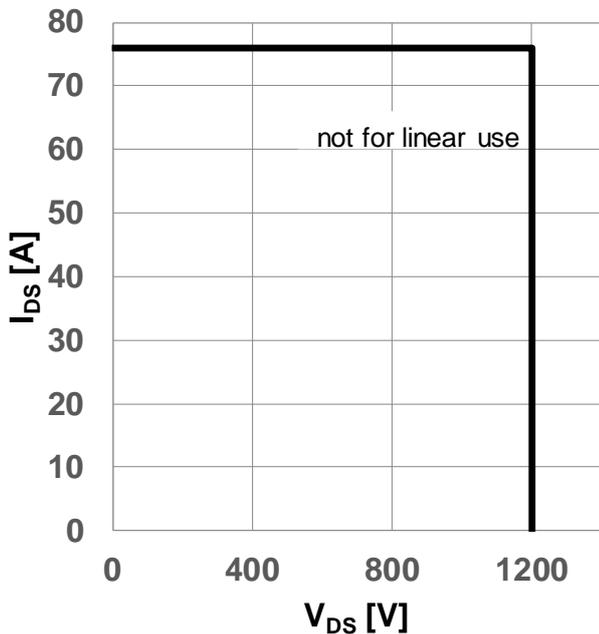

Figure 1 Safe operating area (SOA)
($V_{GS} = 0/18V$, $T_c = 25^\circ C$, $T_j \leq 175^\circ C$)

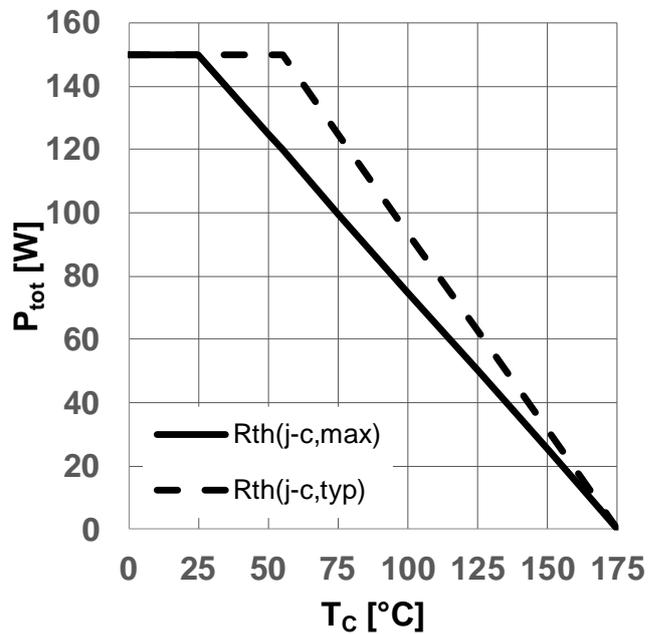

Figure 2 Power dissipation as a function of case temperature limited by bond wire
($P_{tot} = f(T_c)$)

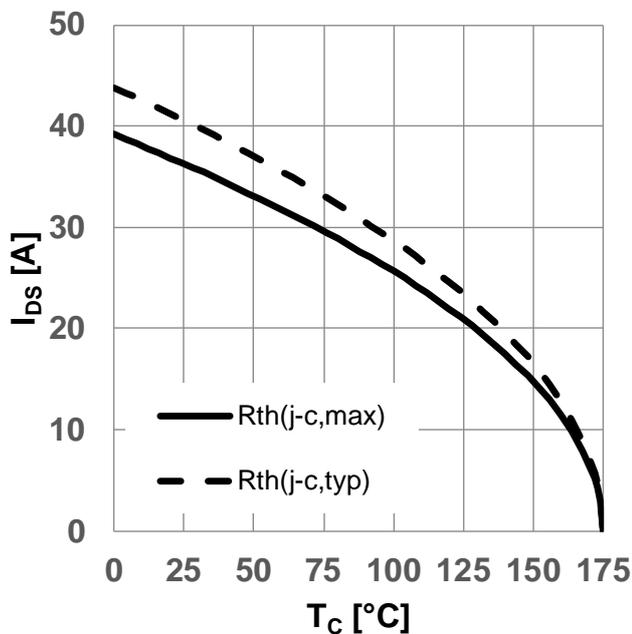

Figure 3 Maximum DC drain to source current as a function of case temperature limited by bond wire ($I_{DS} = f(T_c)$)

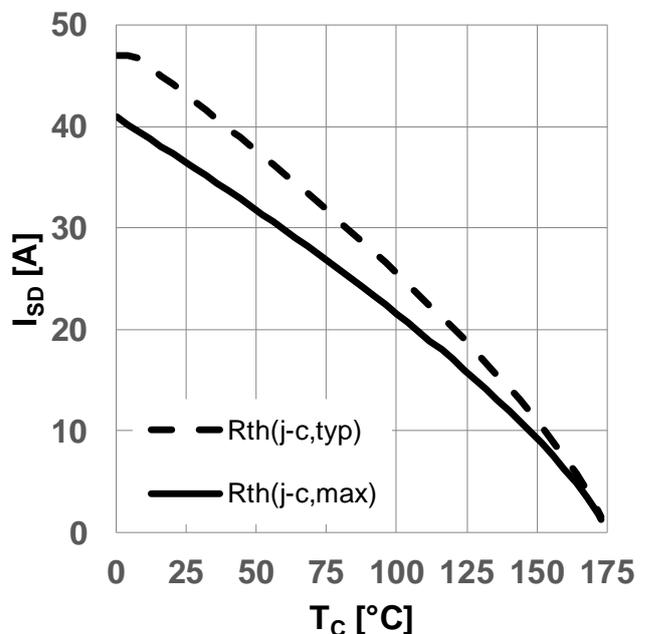

Figure 4 Maximum source to drain current as a function of case temperature limited by bond wire ($I_{SD} = f(T_c)$, $V_{GS} = 0V$)

Electrical characteristic diagrams

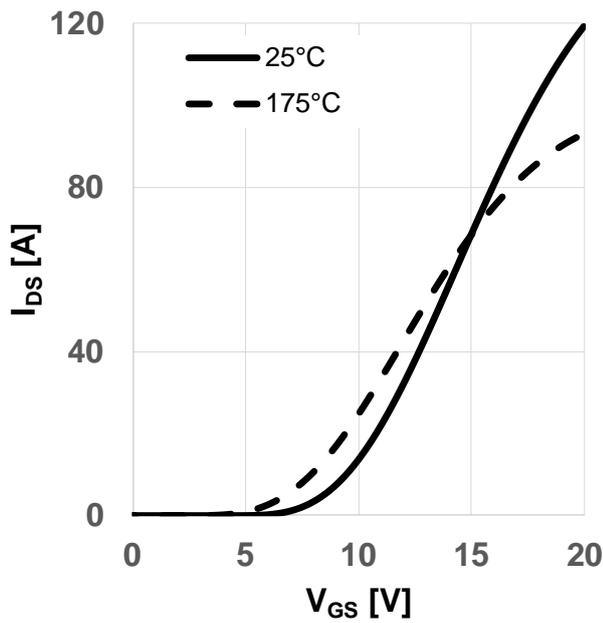

Figure 5 Typical transfer characteristic
 ($I_{DS} = f(V_{GS}), V_{DS} = 20V, t_P = 20\mu s$)

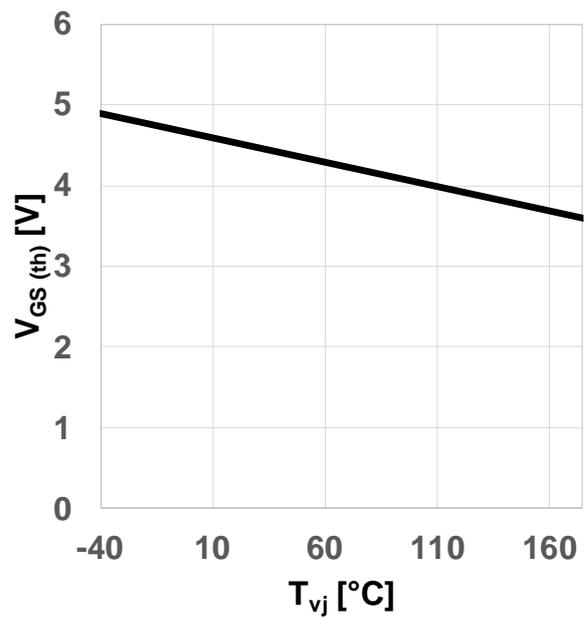

Figure 6 Typical gate-source threshold voltage as a function of junction temperature
 ($V_{GS(th)} = f(T_{vj}), I_{DS} = 5.6mA, V_{GS} = V_{DS}$)

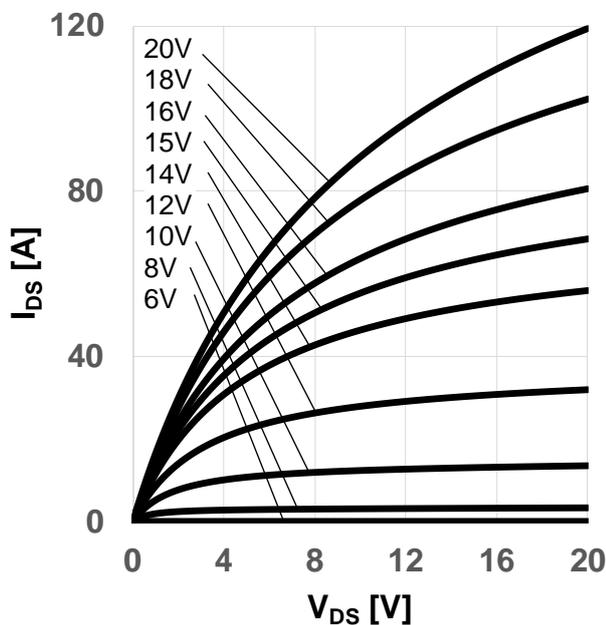

Figure 7 Typical output characteristic, V_{GS} as parameter
 ($I_{DS} = f(V_{DS}), T_{vj} = 25^\circ C, t_P = 20\mu s$)

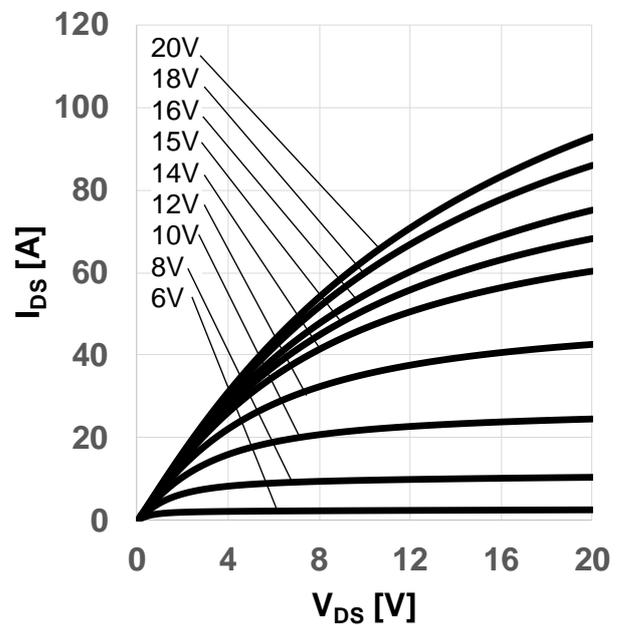

Figure 8 Typical output characteristic, V_{GS} as parameter
 ($I_{DS} = f(V_{DS}), T_{vj} = 175^\circ C, t_P = 20\mu s$)

Electrical characteristic diagrams

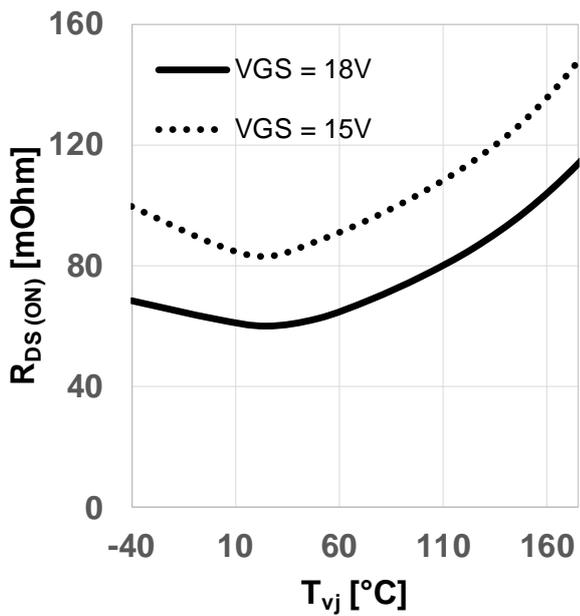

Figure 9 Typical on-resistance as a function of junction temperature
($R_{DS(on)} = f(T_{vj})$, $I_{DS} = 13A$)

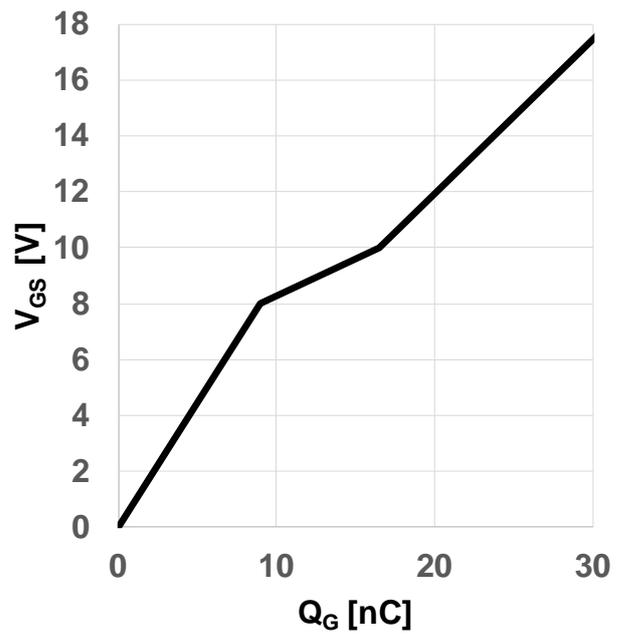

Figure 10 Typical gate charge
($V_{GS} = f(Q_G)$, $I_{DS} = 13A$, $V_{DS} = 800V$, turn-on pulse)

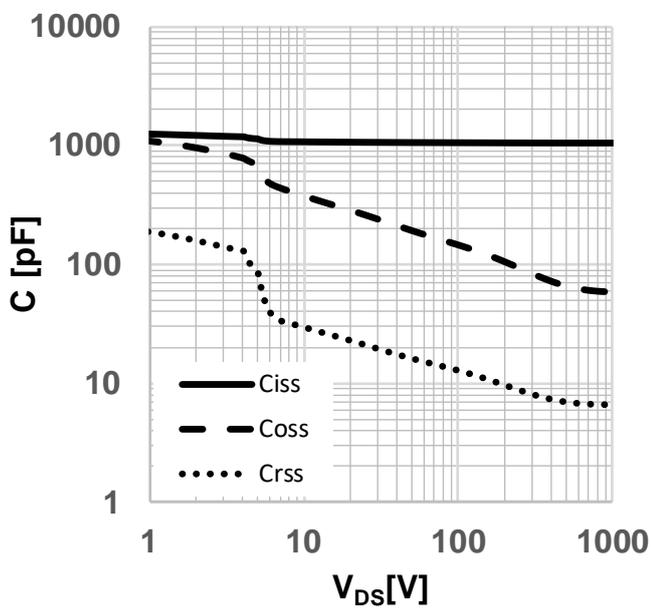

Figure 11 Typical capacitance as a function of drain-source voltage
($C = f(V_{DS})$, $V_{GS} = 0V$, $f = 1MHz$)

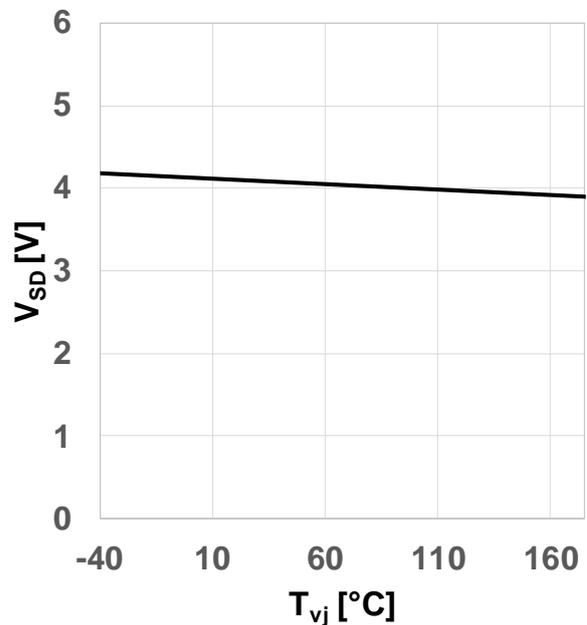

Figure 12 Typical body diode forward voltage as a function of junction temperature
($V_{SD} = f(T_{vj})$, $V_{GS} = 0V$, $I_{SD} = 13A$)

Electrical characteristic diagrams

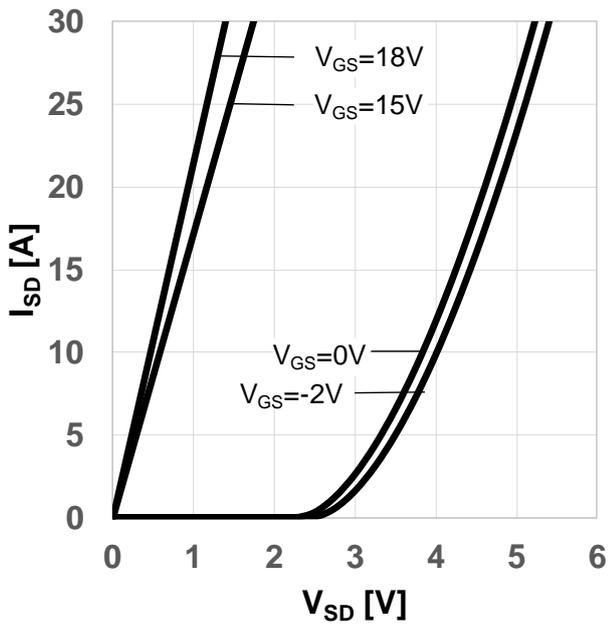

Figure 13 Typical body diode forward current as function of forward voltage, V_{GS} as parameter
($I_{SD} = f(V_{SD})$, $T_{vj} = 25^{\circ}\text{C}$, $t_P = 20\mu\text{s}$)

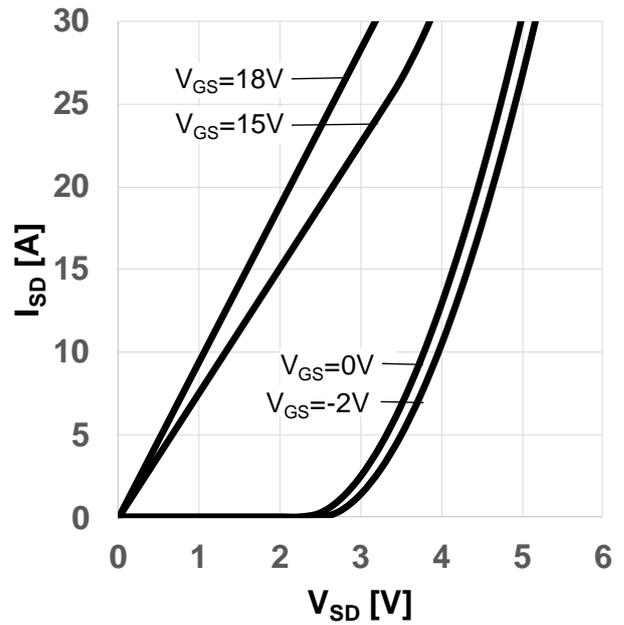

Figure 14 Typical body diode forward current as function of forward voltage, V_{GS} as parameter
($I_{SD} = f(V_{SD})$, $T_{vj} = 175^{\circ}\text{C}$, $t_P = 20\mu\text{s}$)

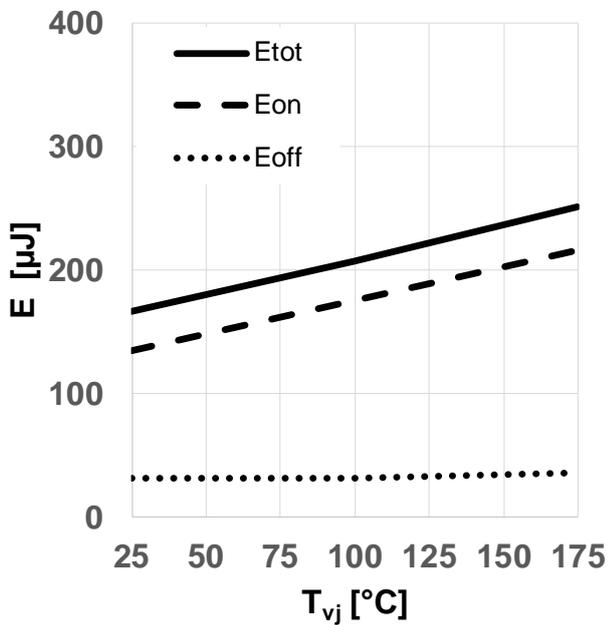

Figure 15 Typical switching energy losses as a function of junction temperature
($E = f(T_{vj})$, $V_{DD} = 800\text{V}$, $V_{GS} = 0\text{V}/18\text{V}$, $R_{G,ext} = 2\Omega$, $I_D = 13\text{A}$, ind. load, test circuit in Fig. E, diode: body diode at $V_{GS} = 0\text{V}$)

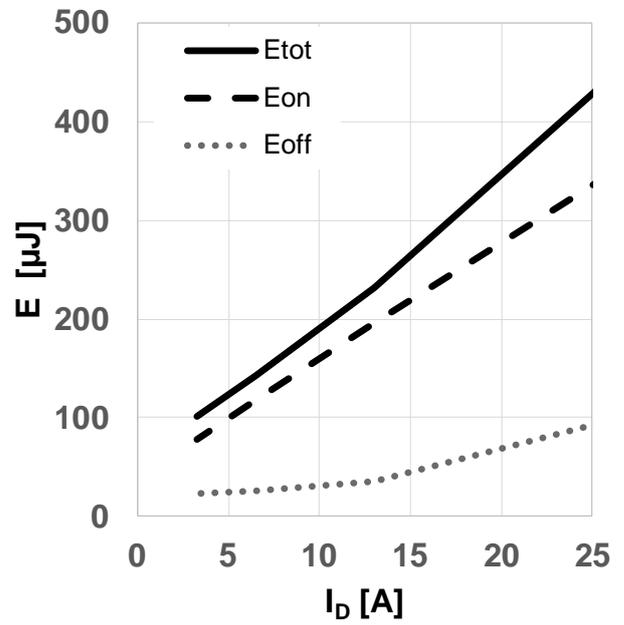

Figure 16 Typical switching energy losses as a function of drain-source current
($E = f(I_{DS})$, $V_{DD} = 800\text{V}$, $V_{GS} = 0\text{V}/18\text{V}$, $R_{G,ext} = 2\Omega$, $T_{vj} = 175^{\circ}\text{C}$, ind. load, test circuit in Fig. E, diode: body diode at $V_{GS} = 0\text{V}$)

Electrical characteristic diagrams

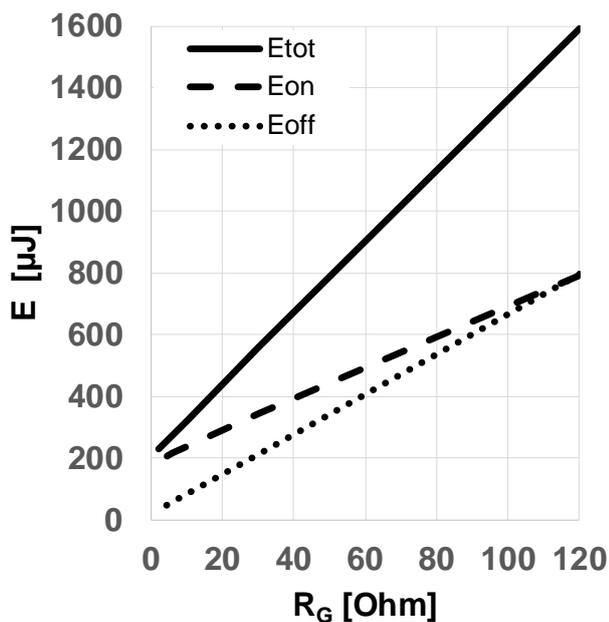

Figure 17 Typical switching energy losses as a function of gate resistance
 $(E = f(R_{G,ext}), V_{DD} = 800V, V_{GS} = 0V/18V, I_D = 13A, T_{vj} = 175^\circ C, \text{ind. load, test circuit in Fig. E, diode: body diode at } V_{GS} = 0V)$

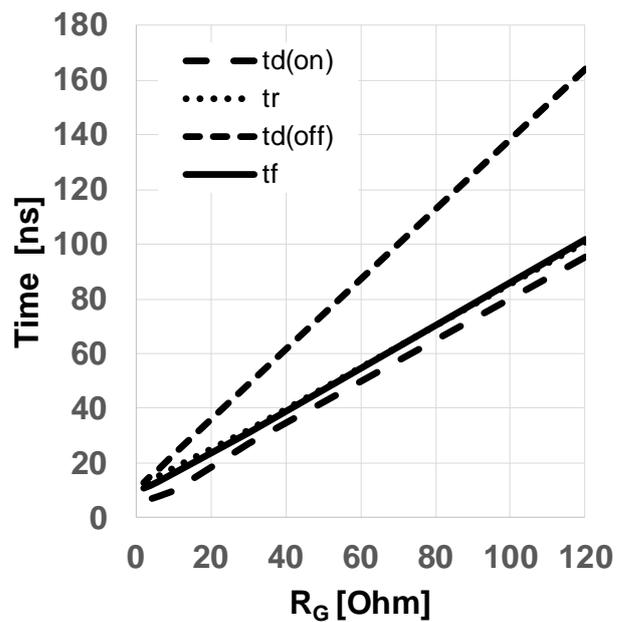

Figure 18 Typical switching times as a function of gate resistor
 $(t = f(R_{G,ext}), V_{DD} = 800V, V_{GS} = 0V/18V, I_D = 13A, T_{vj} = 175^\circ C, \text{ind. load, test circuit in Fig. E, diode: body diode at } V_{GS} = 0V)$

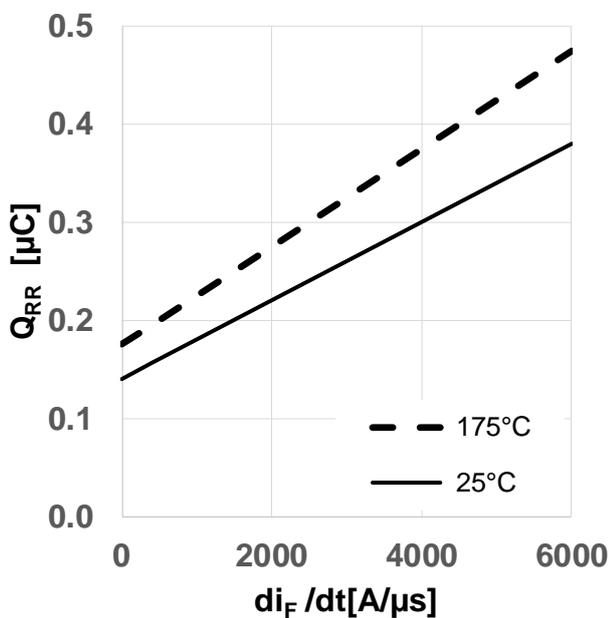

Figure 19 Typical reverse recovery charge as a function of diode current slope
 $(Q_{rr} = f(di_i/dt), V_{DD} = 800V, V_{GS} = 0V/18V, I_D = 13A, \text{ind. load, test circuit in Fig.E, body diode at } V_{GS} = 0V)$

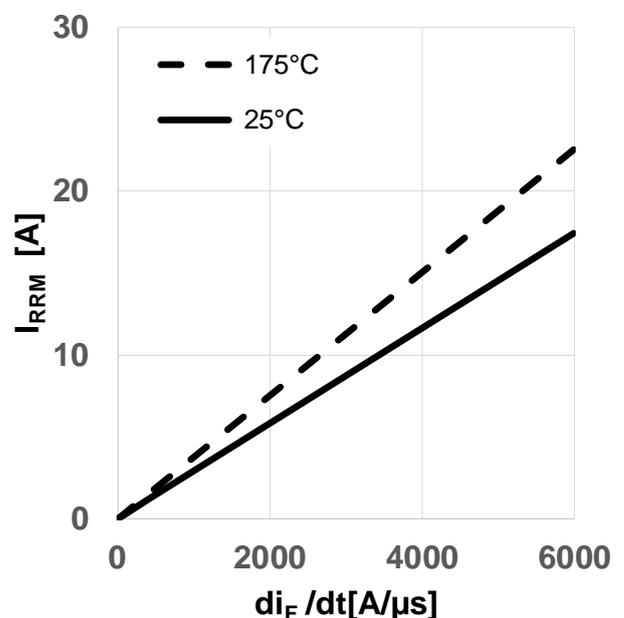

Figure 20 Typical reverse recovery current as a function of diode current slope
 $(I_{rrm} = f(di_i/dt), V_{DD} = 800V, V_{GS} = 0V/18V, I_D = 13A, \text{ind. load, test circuit in Fig.E, body diode at } V_{GS} = 0V)$

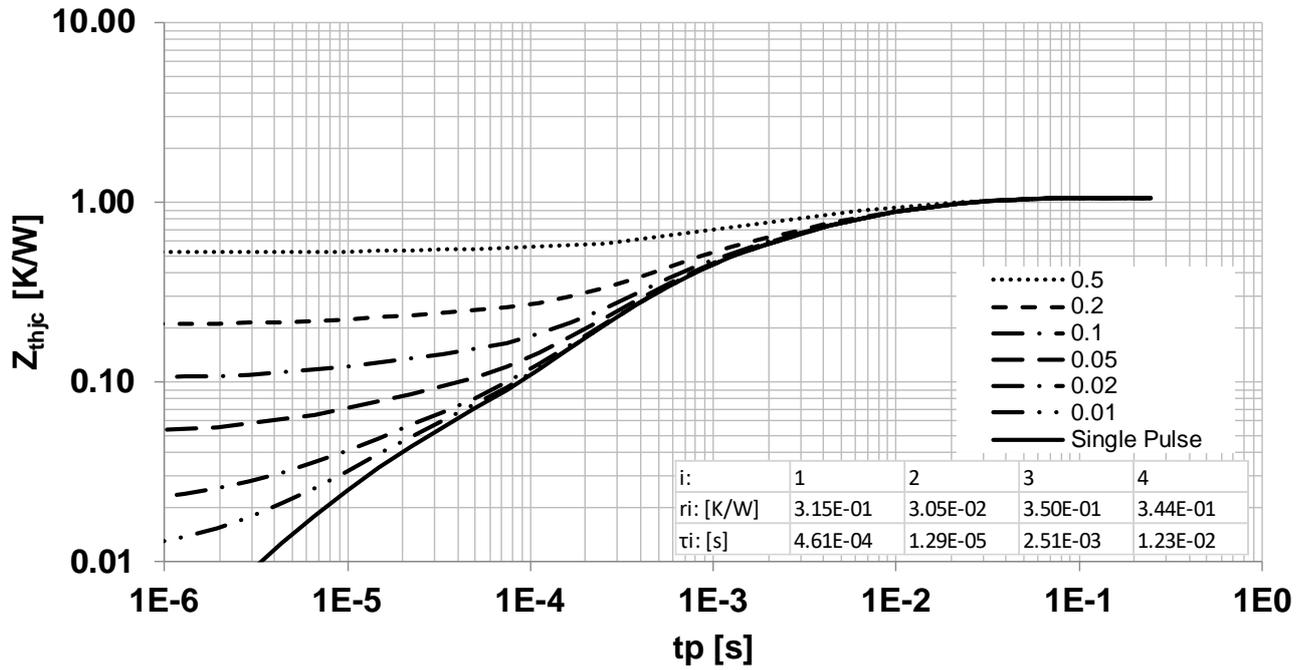

Figure 21 Max. transient thermal resistance (MOSFET/diode)
 $(Z_{th(j-c,max)} = f(t_p), \text{ parameter } D = t_p/T, \text{ thermal equivalent circuit in Fig. D})$

5 Package drawing

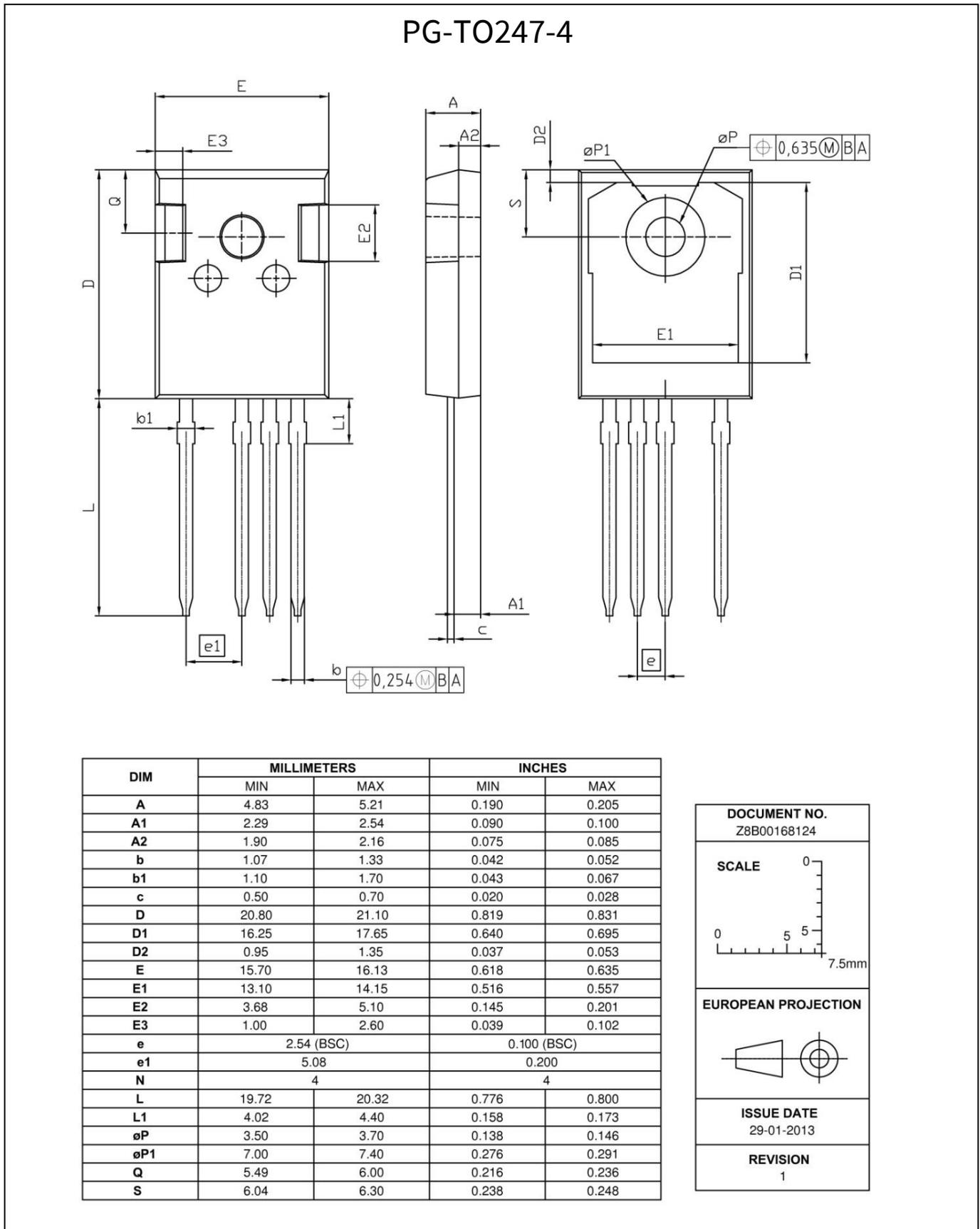

Figure 22 Package drawing

Test conditions

6 Test conditions

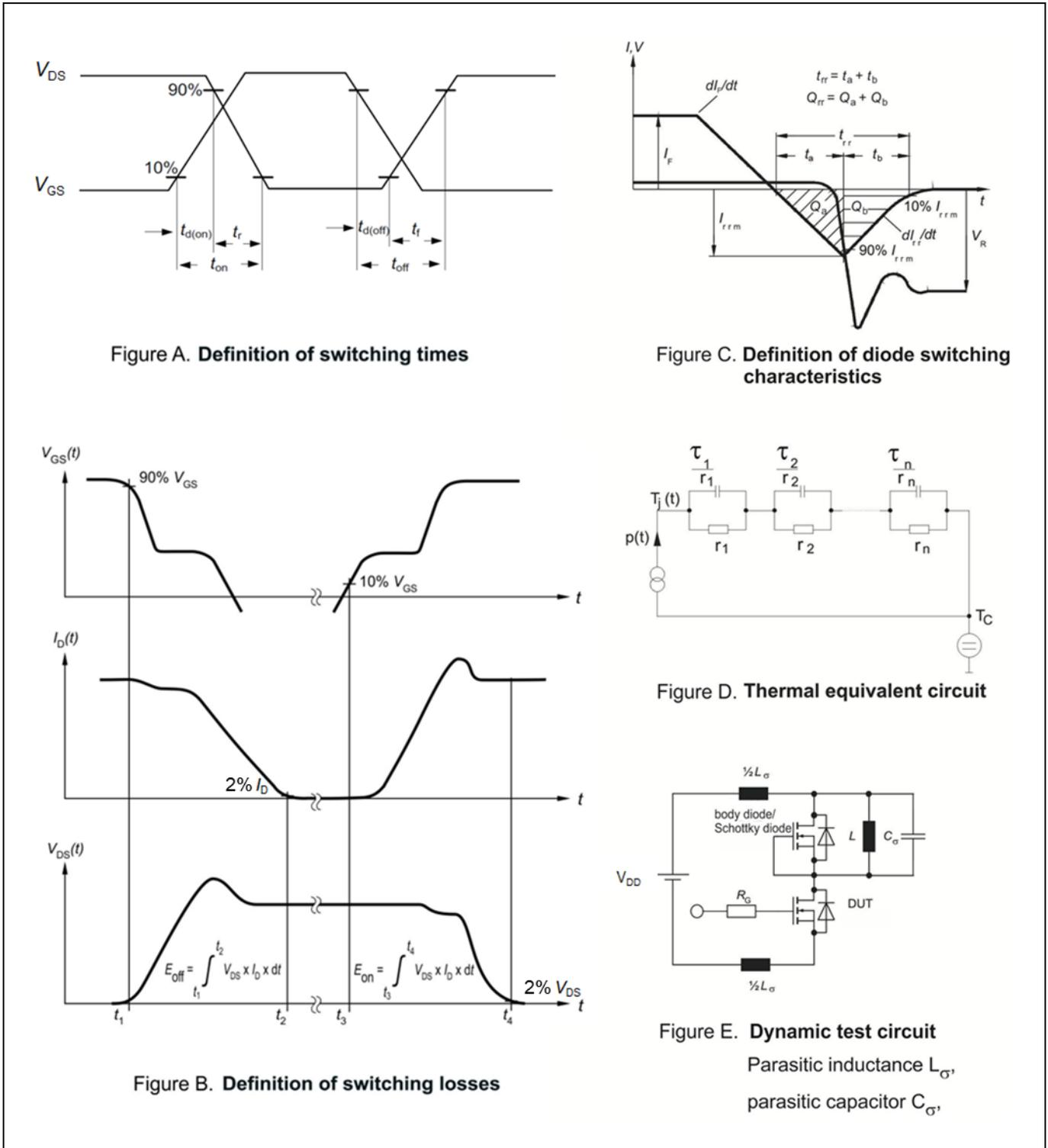

Figure 23 Test conditions

Revision history

Revision history

Document version	Date of release	Description of changes
2.0	2019-08-22	Final Datasheet
2.1	2019-12-10	<ul style="list-style-type: none">• Move the short circuit time from dynamic characteristics table 5 to maximum ratings table 2.• Update the Figure 12, 13, 14 the body diode forward voltage.
2.2	2020-12-11	Correction of circuit symbol on page 1

Trademarks

All referenced product or service names and trademarks are the property of their respective owners.

Published by

Infineon Technologies AG

81726 München, Germany

© Infineon Technologies AG 2019.

All Rights Reserved.

Important notice

The information given in this document shall in no event be regarded as a guarantee of conditions or characteristics (“Beschaffenheitsgarantie”). With respect to any examples, hints or any typical values stated herein and/or any information regarding the application of the product, Infineon Technologies hereby disclaims any and all warranties and liabilities of any kind, including without limitation warranties of non-infringement of intellectual property rights of any third party.

In addition, any information given in this document is subject to customer’s compliance with its obligations stated in this document and any applicable legal requirements, norms and standards concerning customer’s products and any use of the product of Infineon Technologies in customer’s applications.

The data contained in this document is exclusively intended for technically trained staff. It is the responsibility of customer’s technical departments to evaluate the suitability of the product for the intended application and the completeness of the product information given in this document with respect to such application.

For further information on the product, technology, delivery terms and conditions and prices please contact your nearest Infineon Technologies office (www.infineon.com).

Please note that this product is not qualified according to the AEC Q100 or AEC Q101 documents of the Automotive Electronics Council.

Warnings

Due to technical requirements products may contain dangerous substances. For information on the types in question please contact your nearest Infineon Technologies office.

Except as otherwise explicitly approved by Infineon Technologies in a written document signed by authorized representatives of Infineon Technologies, Infineon Technologies’ products may not be used in any applications where a failure of the product or any consequences of the use thereof could result in personal injury.

单击下面可查看定价，库存，交付和生命周期等信息

[>>Infineon\(英飞凌\)](#)