

PNP Silicon High-Voltage Transistors

- Suitable for video output stages in TV sets and switching power supplies
- High breakdown voltage
- Low collector-emitter saturation voltage
- Complementary types: BFN18 (NPN)
- Pb-free (RoHS compliant) package
- Qualified according AEC Q101



| Type | Marking | Pin Configuration | | | Package |
|-------|---------|-------------------|-----|-----|---------|
| BFN19 | DH | 1=B | 2=C | 3=E | SOT89 |

Maximum Ratings

| Parameter | Symbol | Value | Unit |
|---|-----------|-------------|------|
| Collector-emitter voltage | V_{CEO} | 300 | V |
| Collector-base voltage | V_{CBO} | 300 | |
| Emitter-base voltage | V_{EBO} | 5 | |
| Collector current | I_C | 200 | mA |
| Peak collector current, $t_p \leq 10$ ms | I_{CM} | 500 | |
| Base current | I_B | 100 | |
| Peak base current | I_{BM} | 200 | |
| Total power dissipation- $T_S \leq 130$ °C | P_{tot} | 1 | W |
| Junction temperature | T_j | 150 | °C |
| Storage temperature | T_{stg} | -65 ... 150 | |

Thermal Resistance

| Parameter | Symbol | Value | Unit |
|--|------------|-----------|------|
| Junction - soldering point ¹⁾ | R_{thJS} | ≤ 20 | K/W |

¹⁾For calculation of R_{thJA} please refer to Application Note AN077 (Thermal Resistance Calculation)

Electrical Characteristics at $T_A = 25^\circ\text{C}$, unless otherwise specified

| Parameter | Symbol | Values | | | Unit |
|--|---------------|----------------|-------------|-------------|---------------|
| | | min. | typ. | max. | |
| DC Characteristics | | | | | |
| Collector-emitter breakdown voltage $I_C = 1\text{ mA}, I_B = 0$ | $V_{(BR)CEO}$ | 300 | - | - | V |
| Collector-base breakdown voltage $I_C = 100\text{ }\mu\text{A}, I_E = 0$ | $V_{(BR)CBO}$ | 300 | - | - | |
| Emitter-base breakdown voltage $I_E = 100\text{ }\mu\text{A}, I_C = 0$ | $V_{(BR)EBO}$ | 5 | - | - | |
| Collector-base cutoff current $V_{CB} = 250\text{ V}, I_E = 0$ $V_{CB} = 250\text{ V}, I_E = 0, T_A = 150\text{ }^\circ\text{C}$ | I_{CBO} | - | - | 0.1 20 | μA |
| Emitter-base cutoff current $V_{EB} = 5\text{ V}, I_C = 0$ | I_{EBO} | - | - | 100 | nA |
| DC current gain ¹⁾ $I_C = 1\text{ mA}, V_{CE} = 10\text{ V}$ $I_C = 10\text{ mA}, V_{CE} = 10\text{ V}$ $I_C = 30\text{ mA}, V_{CE} = 10\text{ V}$ | h_{FE} | 25 40 30 | - - - | - - - | - |
| Collector-emitter saturation voltage ¹⁾ $I_C = 20\text{ mA}, I_B = 2\text{ mA}$ | V_{CEsat} | - | - | 0.5 | V |
| Base emitter saturation voltage ¹⁾ $I_C = 20\text{ mA}, I_B = 2\text{ mA}$ | V_{BEsat} | - | - | 0.9 | |
| AC Characteristics | | | | | |
| Transition frequency $I_C = 20\text{ MHz}, V_{CE} = 10\text{ V}, f = 20\text{ MHz}$ | f_T | - | 100 | - | MHz |
| Collector-base capacitance $V_{CB} = 30\text{ V}, f = 1\text{ MHz}$ | C_{cb} | - | 2.5 | - | pF |

¹⁾Pulse test: $t < 300\mu\text{s}; D < 2\%$

DC current gain $h_{FE} = f(I_C)$

$V_{CE} = 10\text{ V}$

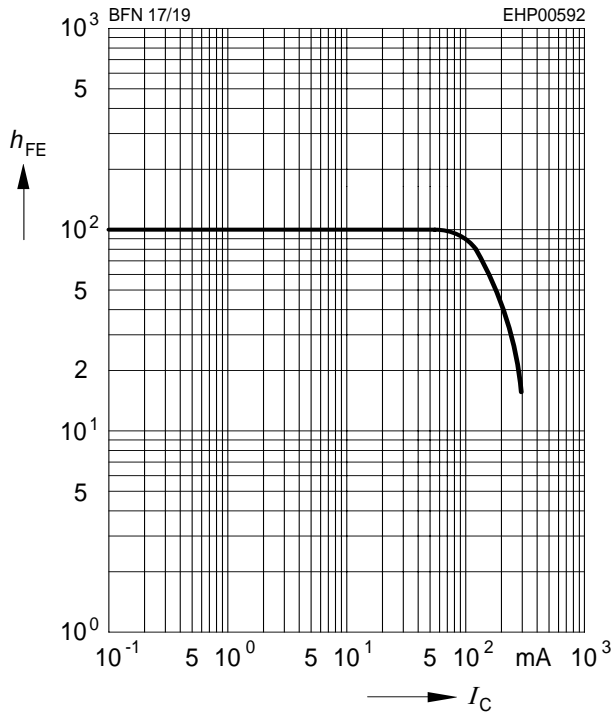

Operating range $I_C = f(V_{CE0})$

$T_A = 25^\circ\text{C}, D = 0$

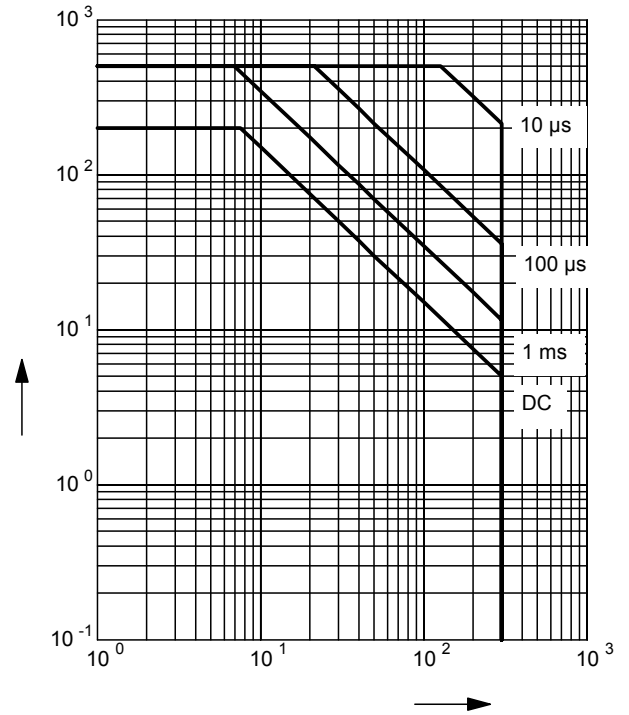

Collector current $I_C = f(V_{BE})$

$V_{CE} = 10\text{ V}$

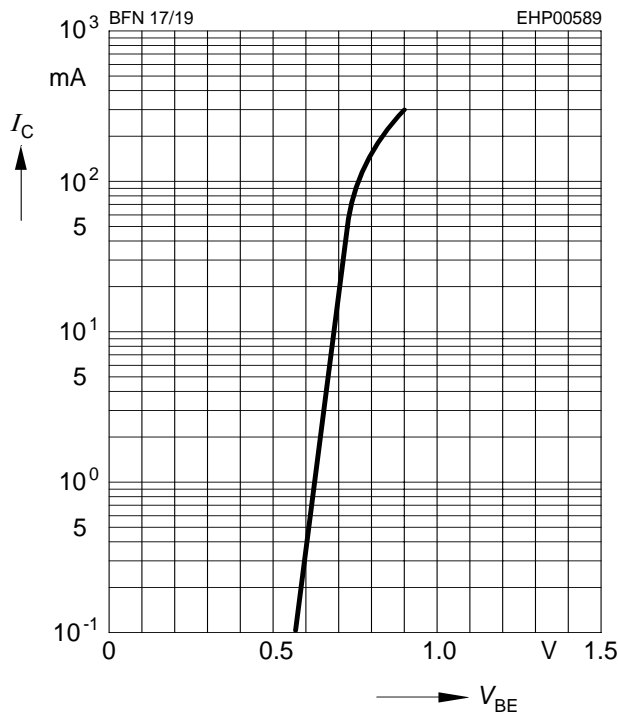

Collector cutoff current $I_{CBO} = f(T_A)$

$V_{CBO} = 200\text{ V}$

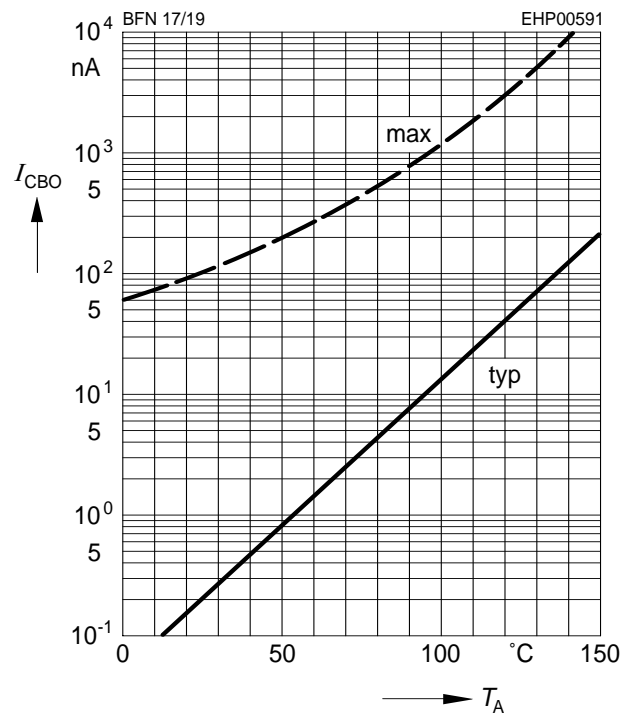

Transition frequency $f_T = f(I_C)$

$V_{CE} = 10\text{ V}$

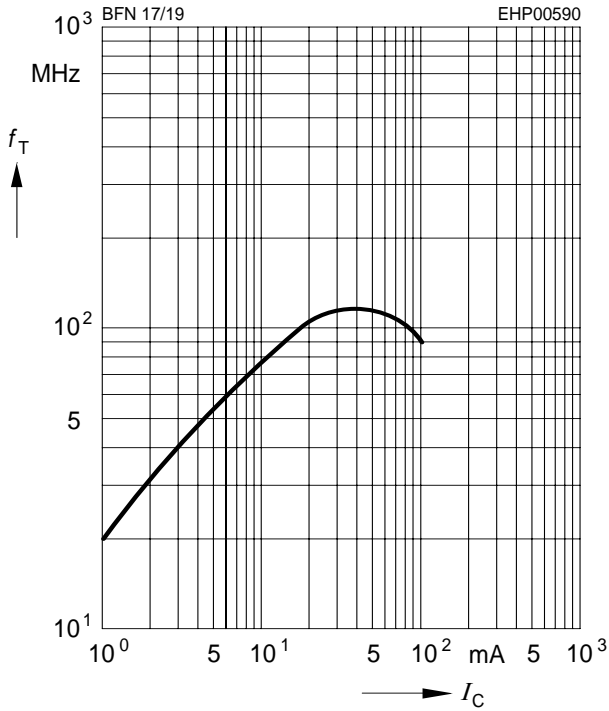

Collector-base capacitance $C_{cb} = f(V_{CB})$

Emitter-base capacitance $C_{eb} = f(V_{EB})$

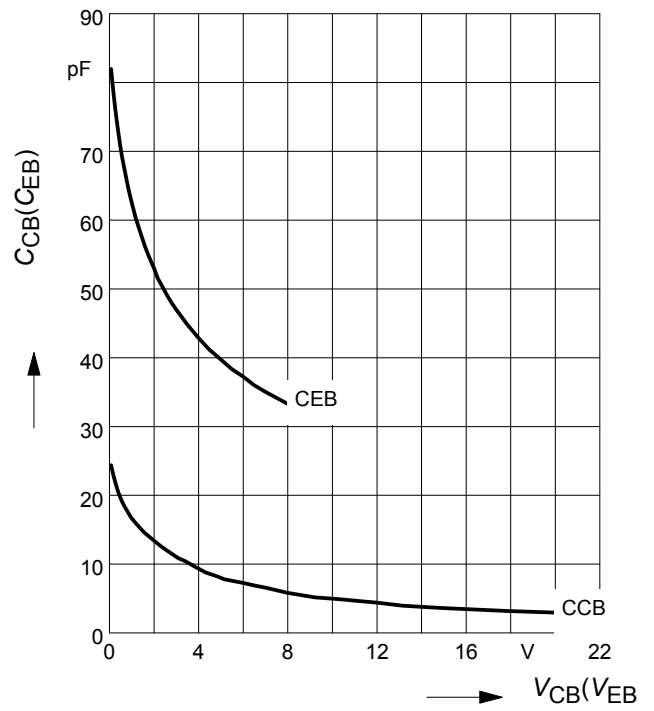

Total power dissipation $P_{tot} = f(T_S)$

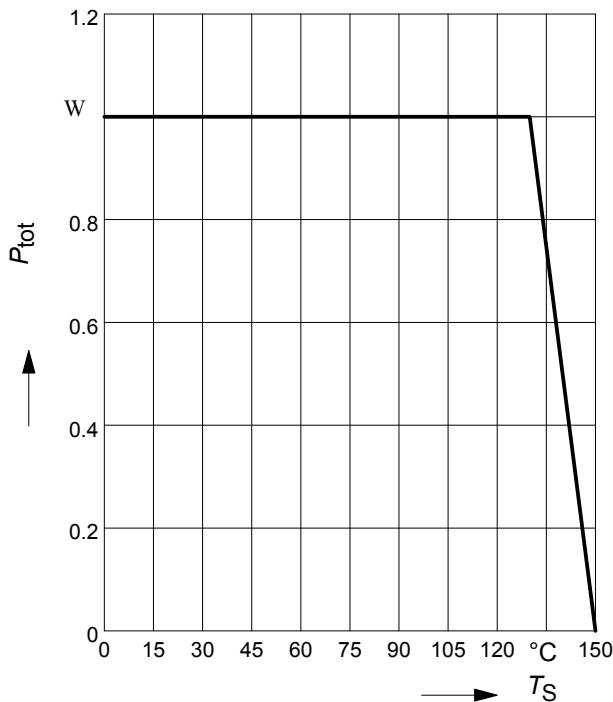

Permissible Pulse Load

$P_{totmax}/P_{totDC} = f(t_p)$

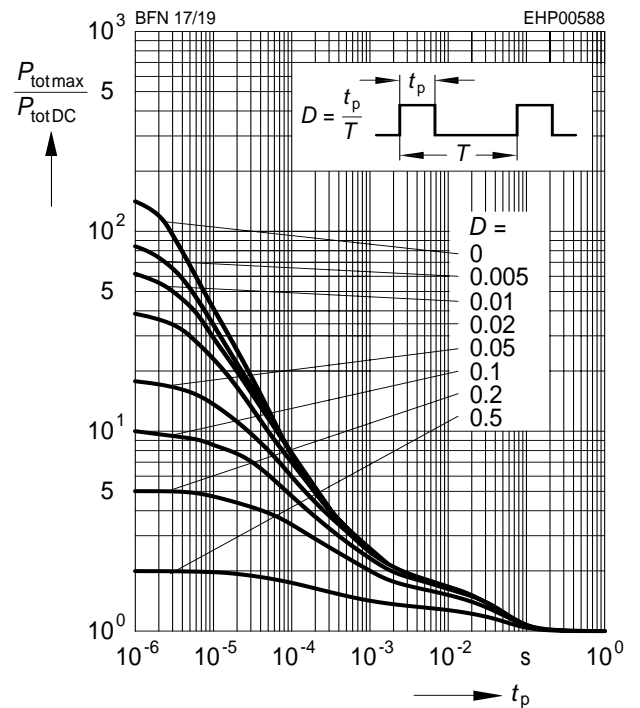

Package Outline

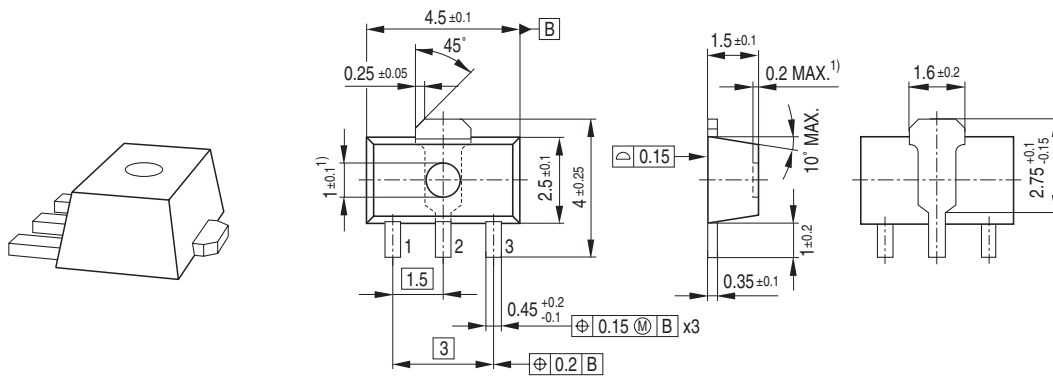

1) Ejector pin markings possible

Foot Print

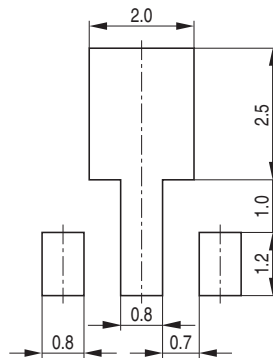

Marking Layout (Example)

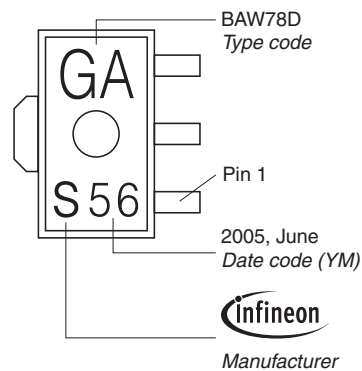

Standard Packing

Reel $\varnothing 180 \text{ mm} = 1.000 \text{ Pieces/Reel}$
 Reel $\varnothing 330 \text{ mm} = 4.000 \text{ Pieces/Reel}$

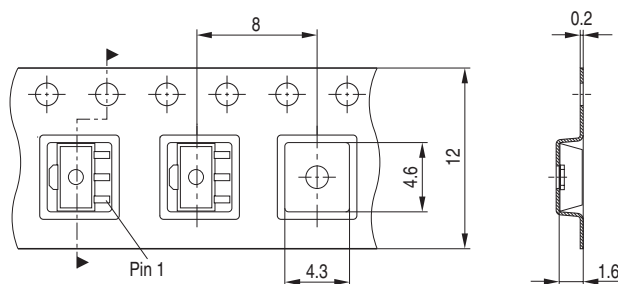

Edition 2009-11-16

**Published by
Infineon Technologies AG
81726 Munich, Germany**

**© 2009 Infineon Technologies AG
All Rights Reserved.**

Legal Disclaimer

The information given in this document shall in no event be regarded as a guarantee of conditions or characteristics. With respect to any examples or hints given herein, any typical values stated herein and/or any information regarding the application of the device, Infineon Technologies hereby disclaims any and all warranties and liabilities of any kind, including without limitation, warranties of non-infringement of intellectual property rights of any third party.

Information

For further information on technology, delivery terms and conditions and prices, please contact the nearest Infineon Technologies Office (www.infineon.com).

Warnings

Due to technical requirements, components may contain dangerous substances. For information on the types in question, please contact the nearest Infineon Technologies Office.

Infineon Technologies components may be used in life-support devices or systems only with the express written approval of Infineon Technologies, if a failure of such components can reasonably be expected to cause the failure of that life-support device or system or to affect the safety or effectiveness of that device or system. Life support devices or systems are intended to be implanted in the human body or to support and/or maintain and sustain and/or protect human life. If they fail, it is reasonable to assume that the health of the user or other persons may be endangered.

单击下面可查看定价，库存，交付和生命周期等信息

[>>Infineon\(英飞凌\)](#)