

**PNP Silicon High Voltage Transistor**

- High breakdown voltage
- Low collector-emitter saturation voltage
- Complementary type: PZTA42 (NPN)

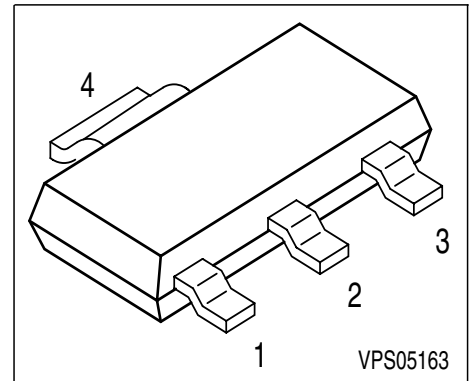

Type	Marking	Pin Configuration				Package
PZTA92	PZTA 92	1=B	2=C	3=E	4=C	SOT223

**Maximum Ratings**

Parameter	Symbol	Value	Unit
Collector-emitter voltage	$V_{CEO}$	300	V
Collector-base voltage	$V_{CBO}$	300	
Emitter-base voltage	$V_{EBO}$	5	
DC collector current	$I_C$	500	mA
Base current	$I_B$	100	
Total power dissipation, $T_S = 124\text{ °C}$	$P_{tot}$	1.5	W
Junction temperature	$T_j$	150	°C
Storage temperature	$T_{stg}$	-65 ... 150	

**Thermal Resistance**

Junction - soldering point <sup>1)</sup>	$R_{thJS}$	≤17	K/W
--	------------	-----	-----

<sup>1)</sup>For calculation of  $R_{thJA}$  please refer to Application Note Thermal Resistance

**Electrical Characteristics at  $T_A = 25^\circ\text{C}$ , unless otherwise specified**

Parameter	Symbol	Values			Unit
		min.	typ.	max.	
<b>DC Characteristics</b>					
Collector-emitter breakdown voltage $I_C = 1 \text{ mA}, I_B = 0$	$V_{(BR)CEO}$	300	-	-	V
Collector-base breakdown voltage $I_C = 100 \mu\text{A}, I_E = 0$	$V_{(BR)CBO}$	300	-	-	
Emitter-base breakdown voltage $I_E = 10 \mu\text{A}, I_C = 0$	$V_{(BR)EBO}$	5	-	-	
Collector cutoff current $V_{CB} = 200 \text{ V}, I_E = 0$	$I_{CBO}$	-	-	250	nA
Collector cutoff current $V_{CB} = 200 \text{ V}, I_E = 0, T_A = 150^\circ\text{C}$	$I_{CBO}$	-	-	20	$\mu\text{A}$
Emitter cutoff current $V_{EB} = 3 \text{ V}, I_C = 0$	$I_{EBO}$	-	-	100	nA
DC current gain 1) $I_C = 1 \text{ mA}, V_{CE} = 10 \text{ V}$ $I_C = 10 \text{ mA}, V_{CE} = 10 \text{ V}$ $I_C = 30 \text{ mA}, V_{CE} = 10 \text{ V}$	$h_{FE}$	25 40 25	- - -	- - -	-
Collector-emitter saturation voltage1) $I_C = 20 \text{ mA}, I_B = 2 \text{ mA}$	$V_{CEsat}$	-	-	0.5	V
Base-emitter saturation voltage 1) $I_C = 20 \text{ mA}, I_B = 2 \text{ mA}$	$V_{BEsat}$	-	-	0.9	
<b>AC Characteristics</b>					
Transition frequency $I_C = 20 \text{ mA}, V_{CE} = 10 \text{ V}, f = 100 \text{ MHz}$	$f_T$	-	100	-	MHz
Collector-base capacitance $V_{CB} = 20 \text{ V}, f = 1 \text{ MHz}$	$C_{cb}$	-	-	6	pF

 1) Pulse test:  $t < 300\mu\text{s}$ ;  $D < 2\%$

**Total power dissipation  $P_{tot} = f(T_S)$**

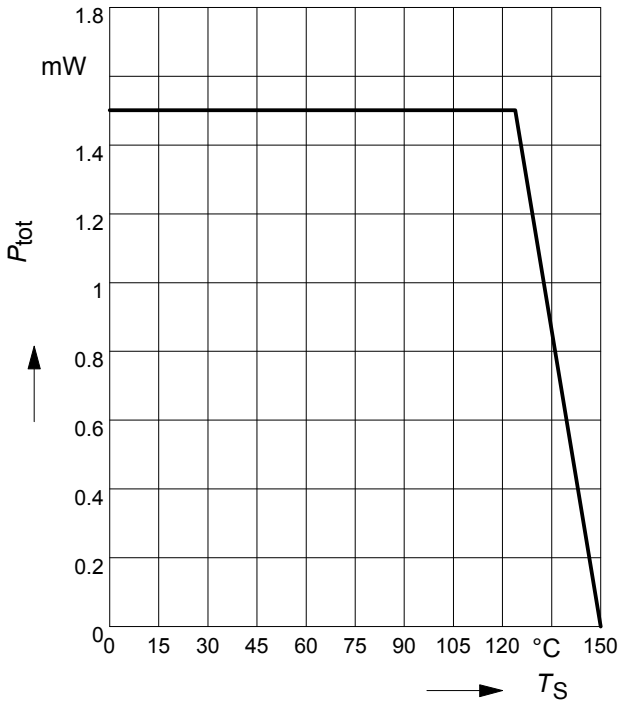

**Transition frequency  $f_T = f(I_C)$**

$V_{CE} = 10V, f = 100MHz$

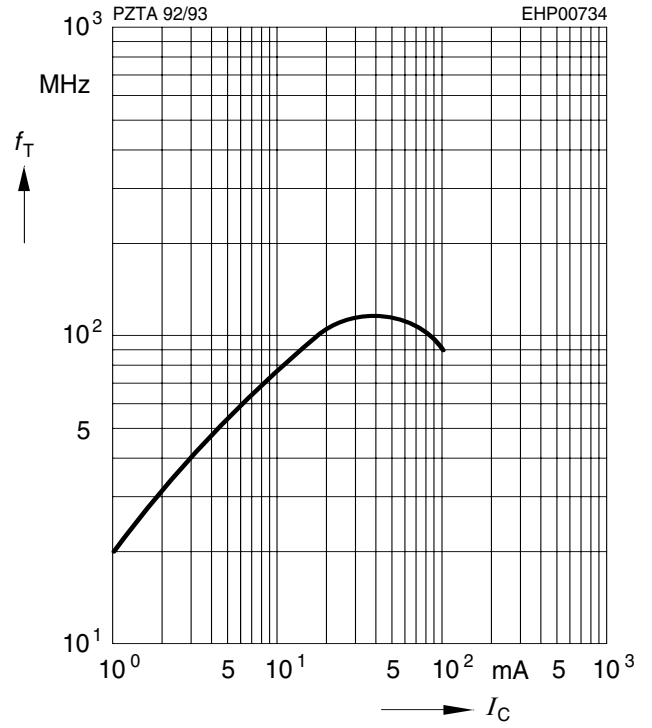

**Permissible pulse load**

$P_{totmax} / P_{totDC} = f(t_p)$

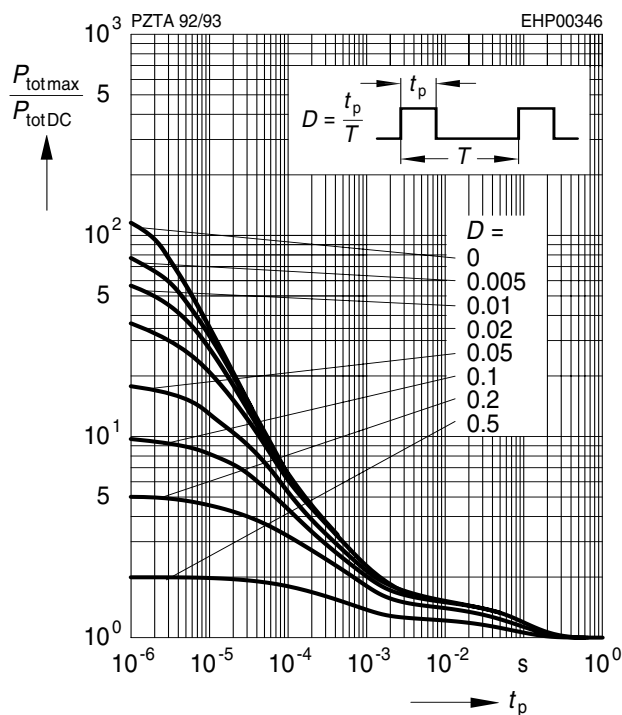

**DC current gain  $h_{FE} = f(I_C)$**

$V_{CE} = 10V$

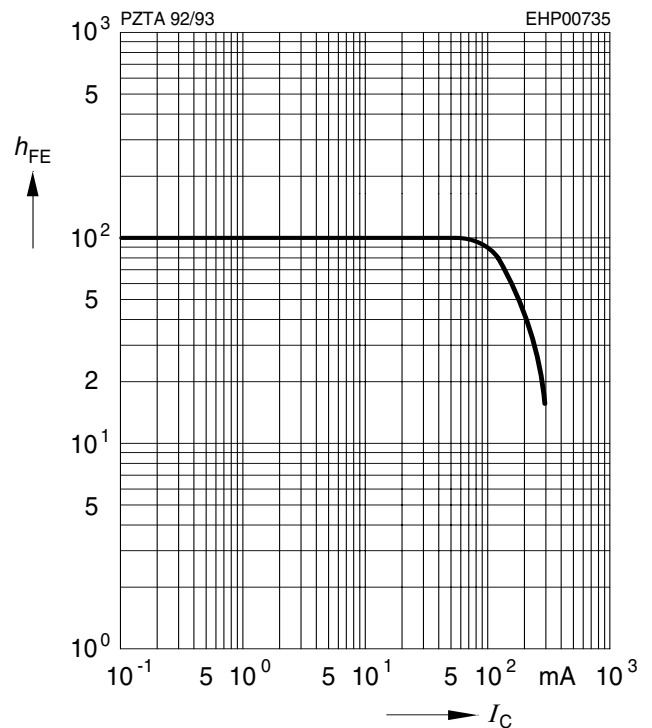

Collector cutoff current  $I_{CBO} = f(T_A)$

$V_{CB} = 200V$

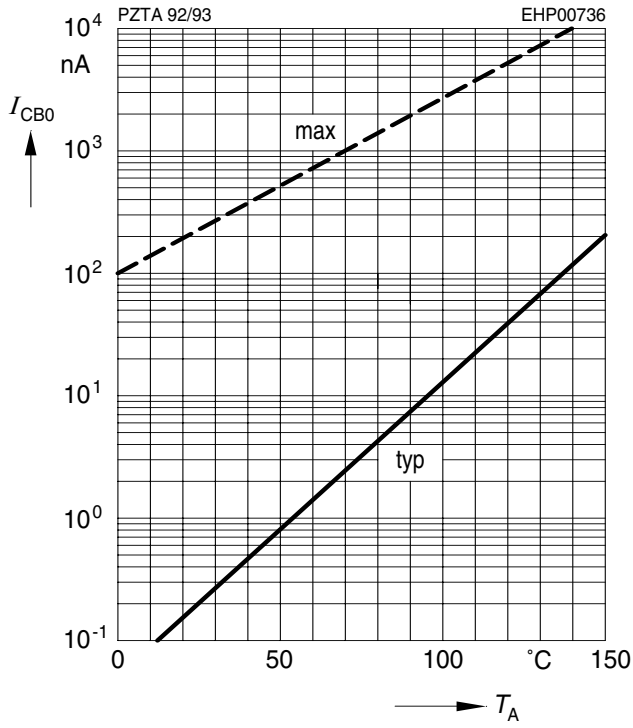

Collector current  $I_C = f(V_{BE})$

$V_{CE} = 10V$

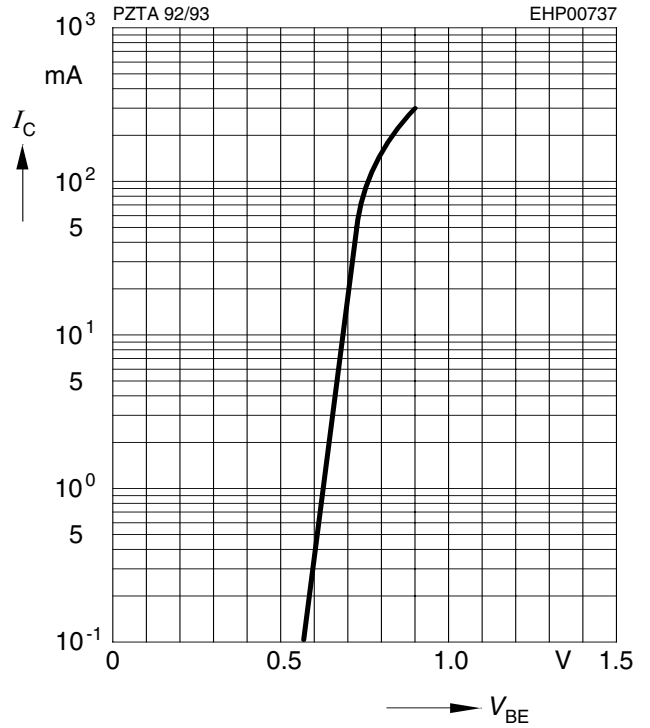

### Package Outline

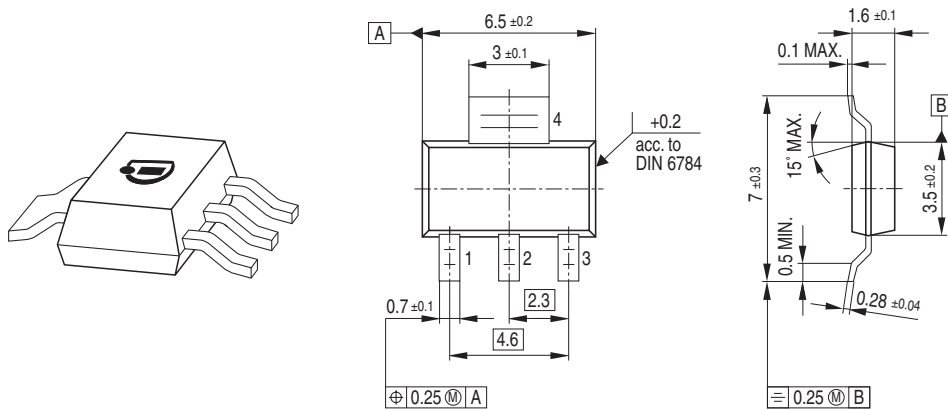

### Foot Print

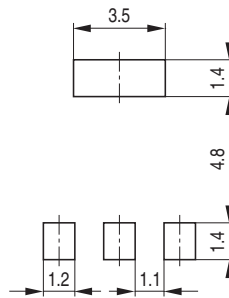

### Marking Layout

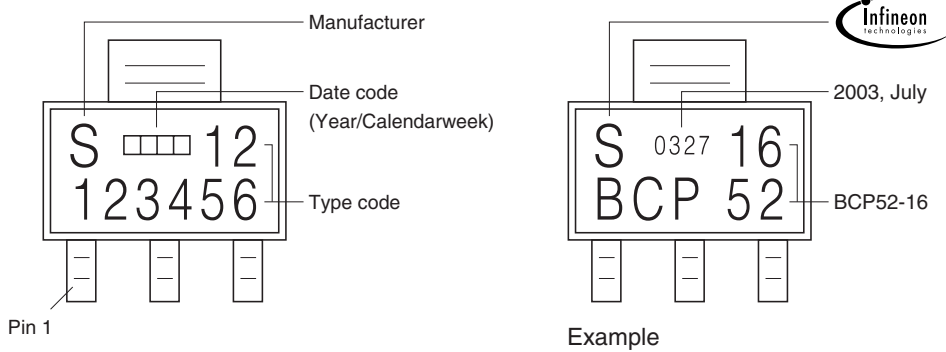

### Packing

Code E6327: Reel  $\varnothing 180$  mm = 1.000 Pieces/Reel  
 Code E6433: Reel  $\varnothing 330$  mm = 4.000 Pieces/Reel

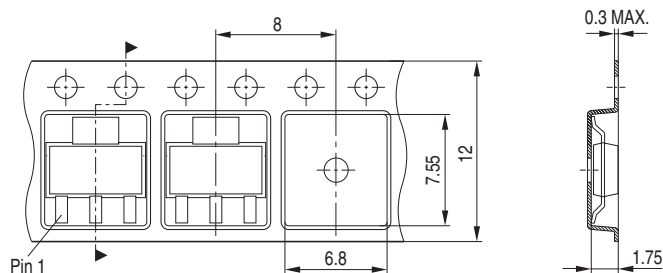

Published by Infineon Technologies AG,  
St.-Martin-Strasse 53,  
81669 München  
© Infineon Technologies AG 2005.  
All Rights Reserved.

### **Attention please!**

The information herein is given to describe certain components and shall not be considered as a guarantee of characteristics.

Terms of delivery and rights to technical change reserved.

We hereby disclaim any and all warranties, including but not limited to warranties of non-infringement, regarding circuits, descriptions and charts stated herein.

### **Information**

For further information on technology, delivery terms and conditions and prices please contact your nearest Infineon Technologies Office ([www.infineon.com](http://www.infineon.com)).

### **Warnings**

Due to technical requirements components may contain dangerous substances. For information on the types in question please contact your nearest Infineon Technologies Office.

Infineon Technologies Components may only be used in life-support devices or systems with the express written approval of Infineon Technologies, if a failure of such components can reasonably be expected to cause the failure of that life-support device or system, or to affect the safety or effectiveness of that device or system. Life support devices or systems are intended to be implanted in the human body, or to support and/or maintain and sustain and/or protect human life. If they fail, it is reasonable to assume that the health of the user or other persons may be endangered.

单击下面可查看定价，库存，交付和生命周期等信息

[>>Infineon\(英飞凌\)](#)