

# Low Dropout Linear Voltage Regulator

## TLS820D0

TLS820D0ELV50

TLS820D0ELV33

## Linear Voltage Regulator

### Data Sheet

Rev. 1.0, 2016-02-08

Automotive Power

## Table of Contents

<b>1</b>	<b>Overview</b> .....	<b>3</b>
<b>2</b>	<b>Block Diagram</b> .....	<b>5</b>
<b>3</b>	<b>Pin Configuration</b> .....	<b>6</b>
3.1	Pin Assignment TLS820D0ELV50 and TLS820D0ELV33 .....	6
3.2	Pin Definitions and Functions TLS820D0ELV50 and TLS820D0ELV33 .....	6
<b>4</b>	<b>General Product Characteristics</b> .....	<b>7</b>
4.1	Absolute Maximum Ratings .....	7
4.2	Functional Range .....	8
4.3	Thermal Resistance .....	9
<b>5</b>	<b>Block Description and Electrical Characteristics</b> .....	<b>10</b>
5.1	Voltage Regulation .....	10
5.2	Typical Performance Characteristics Voltage Regulator .....	13
5.3	Current Consumption .....	16
5.4	Typical Performance Characteristics Current Consumption .....	17
5.5	Enable .....	18
5.6	Typical Performance Characteristics Enable .....	19
5.7	Reset .....	20
5.8	Typical Performance Characteristics Reset .....	25
<b>6</b>	<b>Application Information</b> .....	<b>26</b>
6.1	Application Diagram .....	26
6.2	Selection of External Components .....	26
6.2.1	Input Pin .....	26
6.2.2	Output Pin .....	26
6.3	Thermal Considerations .....	27
6.4	Reverse Polarity Protection .....	28
6.5	Further Application Information .....	28
<b>7</b>	<b>Package Outlines</b> .....	<b>29</b>
<b>8</b>	<b>Revision History</b> .....	<b>30</b>



## 1 Overview

### Features

- Wide Input Voltage Range from 3.0 V to 40 V
- Fixed Output Voltage 5 V or 3.3 V
- Output Voltage Precision  $\leq \pm 2\%$
- Output Current Capability up to 200 mA
- Ultra Low Current Consumption typ. 40  $\mu\text{A}$
- Very Low Dropout Voltage typ. 70 mV @100 mA
- Stable with Ceramic Output Capacitor of 1  $\mu\text{F}$
- Delayed Reset at Power-On with 2 Programmable Delay Times 8.5 ms / 16.5 ms
- Adjustable Reset Threshold down to 2.50 V
- Enable, Undervoltage Reset, Overtemperature Shutdown
- Output Current Limitation
- Wide Temperature Range
- Green Product (RoHS compliant)
- AEC Qualified

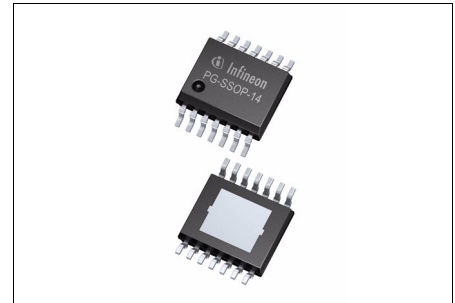

Figure 1 PG-SSOP-14

## Functional Description

The TLS820D0 is a high performance very low dropout linear voltage regulator for 5 V (TLS820D0V50) or 3.3 V (TLS820D0V33) supply in a PG-SSOP-14 package.

With an input voltage range of 3 V to 40 V and very low quiescent of only 40  $\mu$ A, these regulators are perfectly suitable for automotive or any other supply systems connected to the battery permanently. The TLS820D0 provides an output voltage accuracy of 2 % and a maximum output current up to 200 mA.

The new loop concept combines fast regulation and very good stability while requiring only one small ceramic capacitor of 1  $\mu$ F at the output. At currents below 100 mA the device will have a very low typical dropout voltage of only 70 mV (for 5 V device) and 80 mV (for 3.3 V device). The operating range starts already at input voltages of only 3 V (extended operating range). This makes the TLS820D0 also suitable to supply automotive systems that need to operate during cranking condition.

The device can be switched on and off by the Enable feature as described in [Chapter 5.5](#).

The output voltage is supervised by the Reset feature, including Undervoltage Reset, delayed Reset at Power-On and an adjustable lower Reset Threshold, more details can be found in [Chapter 5.7](#).

Internal protection features like output current limitation and overtemperature shutdown are implemented to protect the device against immediate damage due to failures like output short circuit to GND, over-current and over-temperatures.

## Choosing External Components

An input capacitor  $C_I$  is recommended to compensate line influences. The output capacitor  $C_O$  is necessary for the stability of the regulating circuit. TLS820D0 is designed to be also stable with low ESR ceramic capacitors.

Type	Package	Marking
TLS820D0ELV50	PG-SSOP-14	820D0V50
TLS820D0ELV33	PG-SSOP-14	820D0V33

## 2 Block Diagram

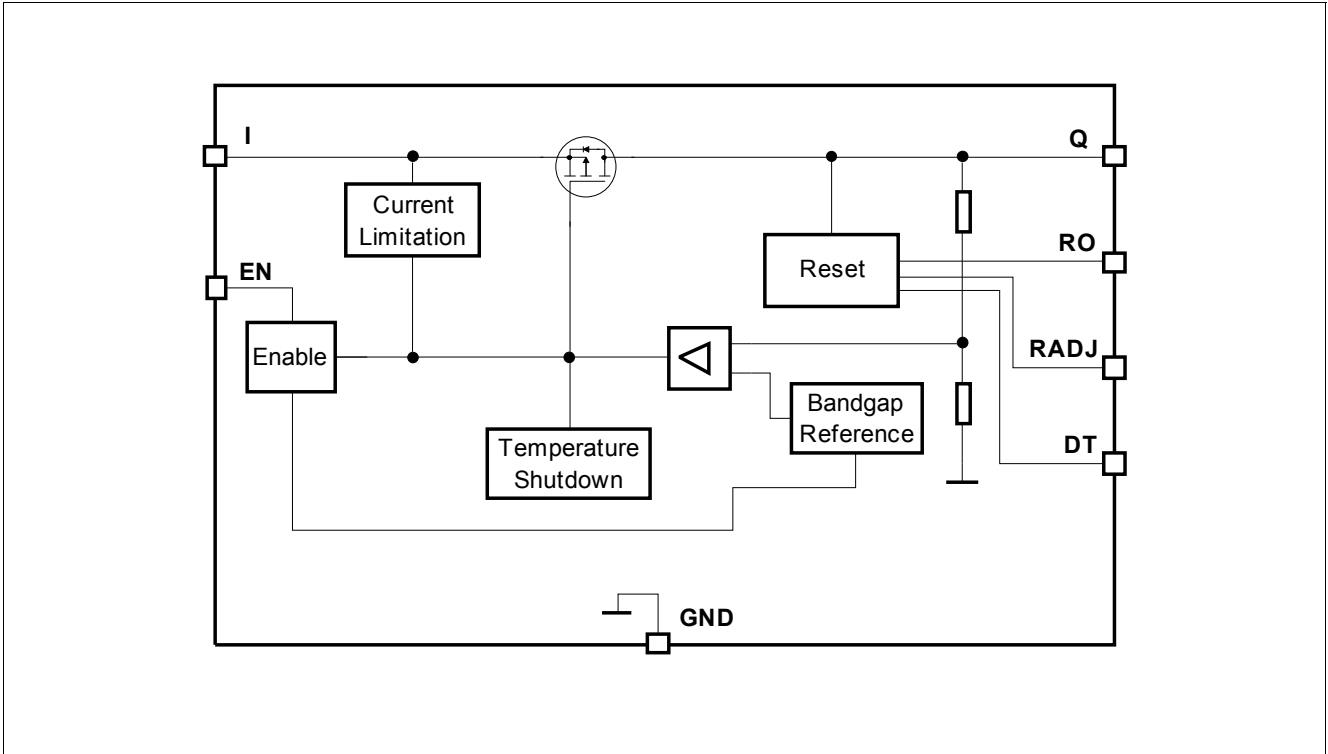

Figure 2 Block Diagram TLS820D0ELV50 and TLS820D0ELV33

### 3 Pin Configuration

#### 3.1 Pin Assignment TLS820D0ELV50 and TLS820D0ELV33

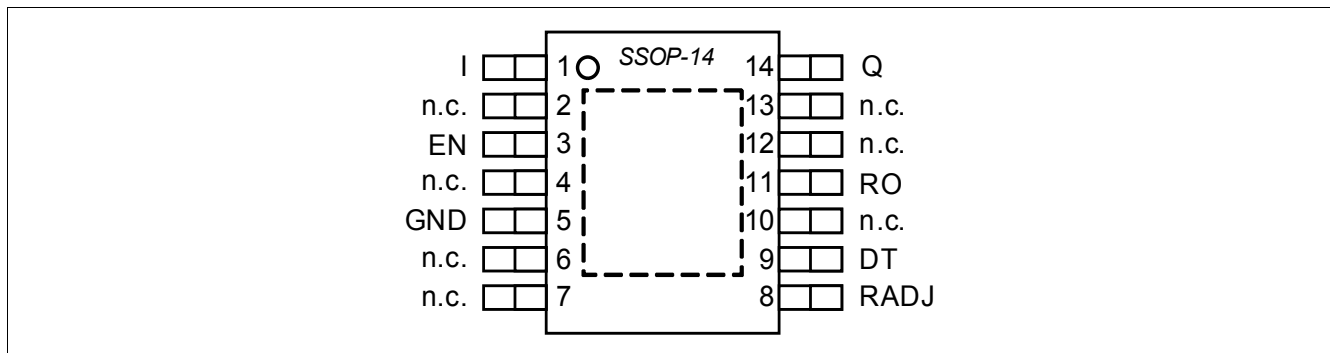

Figure 3 Pin Configuration

#### 3.2 Pin Definitions and Functions TLS820D0ELV50 and TLS820D0ELV33

Pin	Symbol	Function
1	I	<b>Input</b> It is recommended to place a small ceramic capacitor (e.g. 100 nF) to GND, close to the IC terminals, in order to compensate line influences. See also <a href="#">Chapter 6.2.1</a>
2, 4, 6, 7	n.c.	<b>not connected</b> Leave open or connect to GND
3	EN	<b>Enable</b> (integrated pull-down resistor) Enable the IC with high level input signal; Disable the IC with low level input signal;
5	GND	<b>Ground</b>
8	RADJ	<b>Reset Threshold Adjustment</b> Connect to GND to use standard value; Connect an external voltage divider to adjust reset threshold
9	DT	<b>Delay Timing</b> (integrated pull-down resistor) Connect to GND or Q to select Reset timing acc. to <a href="#">Table 8</a>
11	RO	<b>Reset Output</b> (integrated pull-up resistor to Q) Open collector output; Leave open if the reset function is not needed
10, 12, 13	n.c.	<b>not connected</b> Leave open or connect to GND
14	Q	<b>Output Voltage</b> Connect output capacitor $C_Q$ to GND close to the IC's terminals, respecting the values specified for its capacitance and ESR in " <a href="#">Functional Range</a> " on <a href="#">Page 8</a>
Pad	–	<b>Exposed Pad</b> Connect to heatsink area; Connect to GND

## 4 General Product Characteristics

### 4.1 Absolute Maximum Ratings

**Table 1 Absolute Maximum Ratings<sup>1)</sup>**
 $T_j = -40\text{ °C to }+150\text{ °C}$ ; all voltages with respect to ground (unless otherwise specified)

Parameter	Symbol	Values			Unit	Note / Test Condition	Number
		Min.	Typ.	Max.			
<b>Input I, Enable EN</b>							
Voltage	$V_I, V_{EN}$	-0.3	–	45	V	–	P_4.1.1
<b>Output Q, Reset Output RO</b>							
Voltage	$V_Q, V_{RO}$	-0.3	–	7	V	–	P_4.1.3
<b>Delay Timing DT, Reset Threshold Adjustment RADJ</b>							
Voltage	$V_{DT}, V_{RADJ}$	-0.3	–	7	V	–	P_4.1.6
<b>Temperatures</b>							
Junction Temperature	$T_j$	-40	–	150	°C	–	P_4.1.7
Storage Temperature	$T_{stg}$	-55	–	150	°C	–	P_4.1.8
<b>ESD Absorption</b>							
ESD Susceptibility to GND	$V_{ESD}$	-2	–	2	kV	<sup>2)</sup> HBM	P_4.1.9
ESD Susceptibility to GND	$V_{ESD}$	-500	–	500	V	<sup>3)</sup> CDM	P_4.1.10
ESD Susceptibility Pin 1, 7, 8, 14 (corner pins) to GND	$V_{ESD1,7,8,14}$	-750	–	750	V	<sup>3)</sup> CDM	P_4.1.11

1) Not subject to production test, specified by design.

2) ESD susceptibility, HBM according to ANSI/ESDA/JEDEC JS001 (1.5 kΩ, 100 pF)

3) ESD susceptibility, Charged Device Model "CDM" according JEDEC JESD22-C101

**Note:**

1. Stresses above the ones listed here may cause permanent damage to the device. Exposure to absolute maximum rating conditions for extended periods may affect device reliability.
2. Integrated protection functions are designed to prevent IC destruction under fault conditions described in the data sheet. Fault conditions are considered as "outside" normal operating range. Protection functions are not designed for continuous repetitive operation.

## 4.2 Functional Range

**Table 2 Functional Range**
 $T_j = -40\text{ °C to }+150\text{ °C}$ ; all voltages with respect to ground (unless otherwise specified)

Parameter	Symbol	Values			Unit	Note / Test Condition	Number
		Min.	Typ.	Max.			
Input Voltage Range	$V_I$	$V_{Q,nom} + V_{dr}$	–	40	V	<sup>1)</sup> –	P_4.2.1
Extended Input Voltage Range	$V_{I,ext}$	3.0	–	40	V	<sup>2)</sup> –	P_4.2.3
Enable Voltage Range	$V_{EN}$	0	–	40	V	–	P_4.2.5
Output Capacitor's Requirements for Stability	$C_Q$	1	–	–	μF	<sup>3)4)</sup> –	P_4.2.6
ESR	$ESR(C_Q)$	–	–	100	Ω	<sup>3)</sup> –	P_4.2.7
Junction Temperature	$T_j$	-40	–	150	°C	–	P_4.2.9

1) Output current is limited internally and depends on the input voltage, see Electrical Characteristics for more details.

2) When  $V_I$  is between  $V_{I,ext,min}$  and  $V_{Q,nom} + V_{dr}$ ,  $V_Q = V_I - V_{dr}$ . When  $V_I$  is below  $V_{I,ext,min}$ ,  $V_Q$  can drop down to 0 V.

3) Not subject to production test, specified by design.

4) The minimum output capacitance requirement is applicable for a worst case capacitance tolerance of 30%

*Note: Within the functional or operating range, the IC operates as described in the circuit description. The electrical characteristics are specified within the conditions given in the Electrical Characteristics table.*



### 4.3 Thermal Resistance

Note: This thermal data was generated in accordance with JEDEC JESD51 standards. For more information, go to [www.jedec.org](http://www.jedec.org).

**Table 3 Thermal Resistance**

Parameter	Symbol	Values			Unit	Note / Test Condition	Number
		Min.	Typ.	Max.			
<b>Package Version PG-SSOP-14</b>							
Junction to Case	$R_{thJC}$	–	9	–	K/W	<sup>1)</sup> –	P_4.3.1
Junction to Ambient	$R_{thJA}$	–	43	–	K/W	<sup>1)2)</sup> 2s2p board	P_4.3.2
Junction to Ambient	$R_{thJA}$	–	128	–	K/W	<sup>1)3)</sup> 1s0p board, footprint only	P_4.3.3
Junction to Ambient	$R_{thJA}$	–	58	–	K/W	<sup>1)3)</sup> 1s0p board, 300 mm <sup>2</sup> heatsink area on PCB	P_4.3.4
Junction to Ambient	$R_{thJA}$	–	50	–	K/W	<sup>1)3)</sup> 1s0p board, 600 mm <sup>2</sup> heatsink area on PCB	P_4.3.5

- 1) Not subject to production test, specified by design
- 2) Specified  $R_{thJA}$  value is according to Jedec JESD51-2,-5,-7 at natural convection on FR4 2s2p board; The Product (Chip+Package) was simulated on a 76.2 x 114.3 x 1.5 mm<sup>3</sup> board with 2 inner copper layers (2 x 70μm Cu, 2 x 35μm Cu). Where applicable a thermal via array under the exposed pad contacted the first inner copper layer.
- 3) Specified  $R_{thJA}$  value is according to JEDEC JESD 51-3 at natural convection on FR4 1s0p board; The Product (Chip+Package) was simulated on a 76.2 x 114.3 x 1.5 mm<sup>3</sup> board with 1 copper layer (1 x 70μm Cu).

## 5 Block Description and Electrical Characteristics

### 5.1 Voltage Regulation

The output voltage  $V_Q$  is divided by a resistor network. This fractional voltage is compared to an internal voltage reference and the pass transistor is driven accordingly.

The control loop stability depends on the output capacitor  $C_Q$ , the load current, the chip temperature and the internal circuit design. To ensure stable operation, the output capacitor's capacitance and its equivalent series resistor (ESR) requirements given in "Functional Range" on Page 8 have to be maintained. For details, also see the typical performance graph "Output Capacitor Series Resistor ESR(CQ) versus Output Current IQ" on Page 15. As the output capacitor also has to buffer load steps, it should be sized according to the application's needs.

An input capacitor  $C_I$  is recommended to compensate line influences. In order to block influences like pulses and HF distortion at input side, an additional reverse polarity protection diode and a combination of several capacitors for filtering should be used. Connect the capacitors close to the component's terminals.

In order to prevent overshoots during start-up, a smooth ramp up function is implemented. This ensures almost no output voltage overshoots during start-up, mostly independent from load and output capacitance.

Whenever the load current exceeds the specified limit, e.g. in case of a short circuit, the output current is limited and the output voltage decreases.

The overtemperature shutdown circuit prevents the IC from immediate destruction under fault conditions (e.g. output continuously short-circuit) by switching off the power stage. After the chip has cooled down, the regulator restarts. This leads to an oscillatory behavior of the output voltage until the fault is removed. However, junction temperatures above 150 °C are outside the maximum ratings and therefore significantly reduce the IC's lifetime.

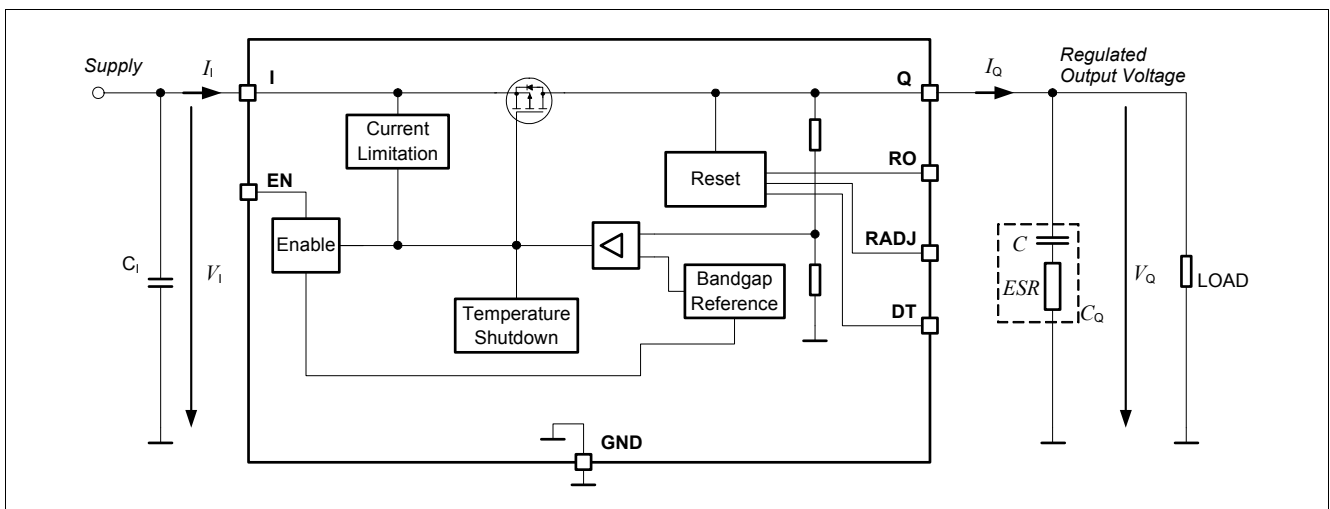

Figure 4 Voltage Regulation

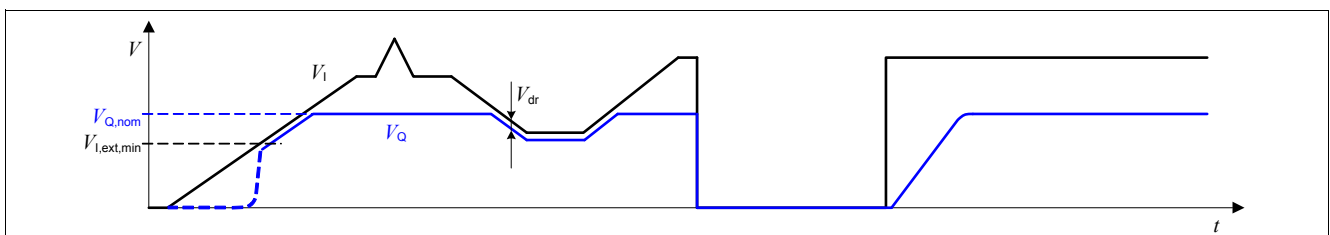

Figure 5 Output Voltage vs. Input Voltage

**Table 4 Electrical Characteristics Voltage Regulator 5 V version**

$T_j = -40\text{ °C}$  to  $+150\text{ °C}$ ,  $V_I = 13.5\text{ V}$ , all voltages with respect to ground (unless otherwise specified)  
 Typical values are given at  $T_j = 25\text{ °C}$

Parameter	Symbol	Values			Unit	Note / Test Condition	Number
		Min.	Typ.	Max.			
Output Voltage Precision	$V_Q$	4.9	5.0	5.1	V	$0.05\text{ mA} < I_Q < 200\text{ mA}$ $5.44\text{ V} < V_I < 28\text{ V}$	P_5.1.1
Output Voltage Precision	$V_Q$	4.9	5.0	5.1	V	$0.05\text{ mA} < I_Q < 100\text{ mA}$ $5.27\text{ V} < V_I < 40\text{ V}$	P_5.1.2
Output Voltage Start-up slew rate	$dV_Q/dt$	3.0	7.5	18	V/ms	$V_I > 18\text{ V/ms}$ $C_Q = 1\text{ }\mu\text{F}$ $0.5\text{ V} < V_Q < 4.5\text{ V}$	P_5.1.7
Output Current Limitation	$I_{Q,max}$	201	350	550	mA	$0\text{ V} < V_Q < 4.8\text{ V}$	P_5.1.8
Load Regulation steady-state	$\Delta V_{Q,load}$	-15	-1.5	5	mV	$I_Q = 0.05\text{ mA}$ to $200\text{ mA}$ $V_I = 6\text{ V}$	P_5.1.10
Line Regulation steady-state	$\Delta V_{Q,line}$	-20	0	20	mV	$V_I = 8\text{ V}$ to $32\text{ V}$ $I_Q = 1\text{ mA}$	P_5.1.12
Dropout Voltage $V_{dr} = V_I - V_Q$	$V_{dr}$	–	140	340	mV	<sup>1)</sup> $I_Q = 200\text{ mA}$	P_5.1.14
Dropout Voltage $V_{dr} = V_I - V_Q$	$V_{dr}$	–	70	170	mV	<sup>1)</sup> $I_Q = 100\text{ mA}$	P_5.1.15
Power Supply Ripple Rejection	$PSRR$	–	59	–	dB	<sup>2)</sup> $f_{ripple} = 100\text{ Hz}$ $V_{ripple} = 0.5\text{ Vpp}$	P_5.1.18
Overtemperature Shutdown Threshold	$T_{j,sd}$	151	–	200	°C	<sup>2)</sup> $T_j$ increasing	P_5.1.19
Overtemperature Shutdown Threshold Hysteresis	$T_{j,sdh}$	–	15	–	K	<sup>2)</sup> $T_j$ decreasing	P_5.1.20

1) Measured when the output voltage  $V_Q$  has dropped 100 mV from the nominal value obtained at  $V_I = 13.5\text{ V}$

2) Not subject to production test, specified by design

**Table 5 Electrical Characteristics Voltage Regulator 3.3 V version**

$T_j = -40\text{ °C}$  to  $+150\text{ °C}$ ,  $V_I = 13.5\text{ V}$ , all voltages with respect to ground (unless otherwise specified)  
 Typical values are given at  $T_j = 25\text{ °C}$

Parameter	Symbol	Values			Unit	Note / Test Condition	Number
		Min.	Typ.	Max.			
Output Voltage Precision	$V_Q$	3.23	3.3	3.37	V	$0.05\text{ mA} < I_Q < 200\text{ mA}$ $3.72\text{ V} < V_I < 28\text{ V}$	P_5.1.21
Output Voltage Precision	$V_Q$	3.23	3.3	3.37	V	$0.05\text{ mA} < I_Q < 100\text{ mA}$ $3.55\text{ V} < V_I < 40\text{ V}$	P_5.1.22
Output Voltage Start-up slew rate	$dV_Q/dt$	3.0	7.5	18	V/ms	$V_I > 18\text{ V/ms}$ $C_Q = 1\text{ }\mu\text{F}$ $0.33\text{ V} < V_Q < 2.97\text{ V}$	P_5.1.27
Output Current Limitation	$I_{Q,max}$	201	350	550	mA	$0\text{ V} < V_Q < 3.1\text{ V}$	P_5.1.28
Load Regulation steady-state	$\Delta V_{Q,load}$	-15	-1.5	5	mV	$I_Q = 0.05\text{ mA}$ to $200\text{ mA}$ $V_I = 6\text{ V}$	P_5.1.30
Line Regulation steady-state	$\Delta V_{Q,line}$	-15	0	15	mV	$V_I = 8\text{ V}$ to $32\text{ V}$ $I_Q = 1\text{ mA}$	P_5.1.32
Dropout Voltage $V_{dr} = V_I - V_Q$	$V_{dr}$	–	160	350	mV	<sup>1)</sup> $I_Q = 200\text{ mA}$	P_5.1.34
Dropout Voltage $V_{dr} = V_I - V_Q$	$V_{dr}$	–	80	175	mV	<sup>1)</sup> $I_Q = 100\text{ mA}$	P_5.1.35
Power Supply Ripple Rejection	$PSRR$	–	63	–	dB	<sup>2)</sup> $f_{ripple} = 100\text{ Hz}$ $V_{ripple} = 0.5\text{ Vpp}$	P_5.1.38
Overtemperature Shutdown Threshold	$T_{j,sd}$	151	–	200	°C	<sup>2)</sup> $T_j$ increasing	P_5.1.39
Overtemperature Shutdown Threshold Hysteresis	$T_{j,sdh}$	–	15	–	K	<sup>2)</sup> $T_j$ decreasing	P_5.1.40

1) Measured when the output voltage  $V_Q$  has dropped 100 mV from the nominal value obtained at  $V_I = 13.5\text{ V}$

2) Not subject to production test, specified by design

## 5.2 Typical Performance Characteristics Voltage Regulator

### Typical Performance Characteristics

Output Voltage  $V_Q$  versus Junction Temperature  $T_j$  (3.3 V version)

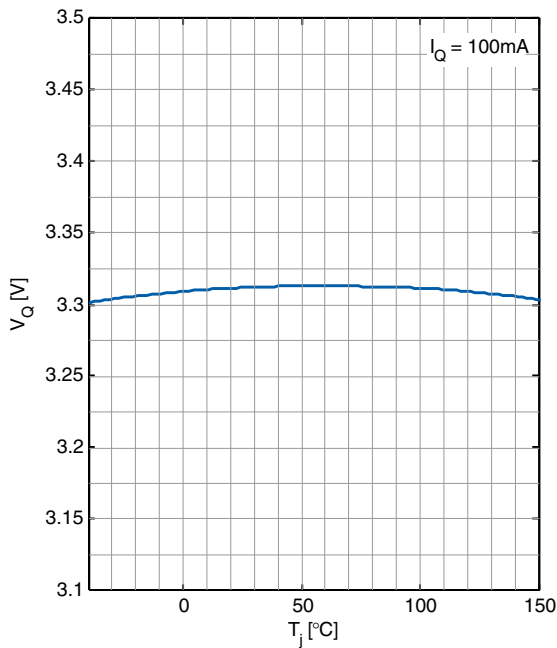

Output Voltage  $V_Q$  versus Junction Temperature  $T_j$  (5 V version)

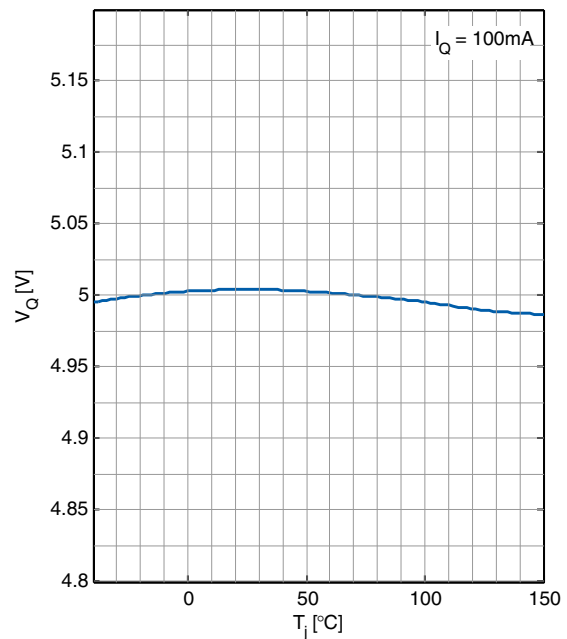

Dropout Voltage  $V_{dr}$  versus Junction Temperature  $T_j$  (3.3 V version)

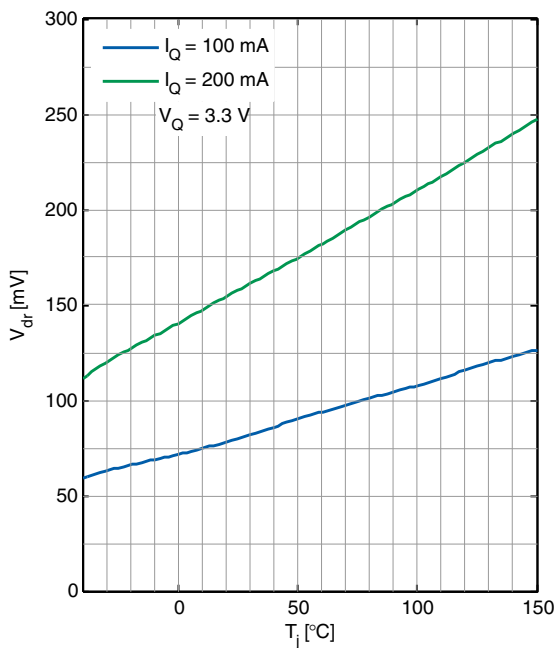

Dropout Voltage  $V_{dr}$  versus Junction Temperature  $T_j$  (5 V version)

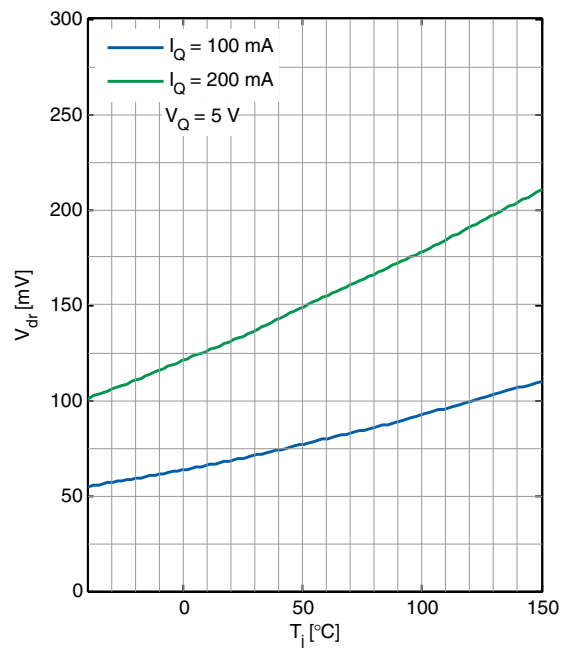

**Load Regulation  $\Delta V_{Q,load}$  versus Output Current Change  $I_Q$**

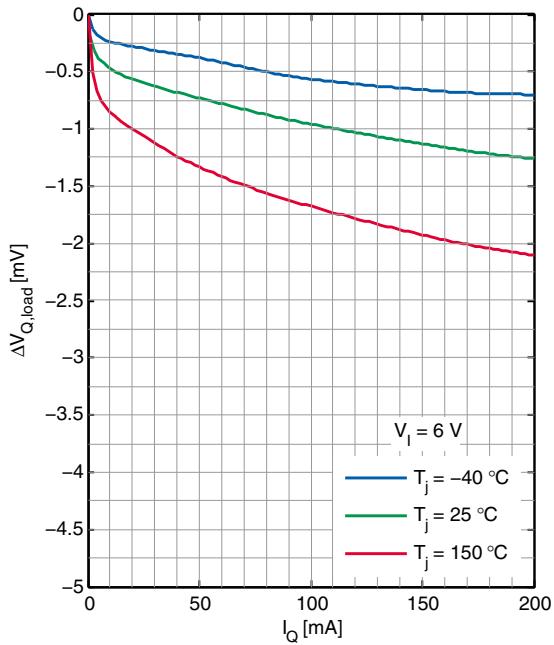

**Line Regulation  $\Delta V_{Q,line}$  versus Input Voltage  $V_I$**

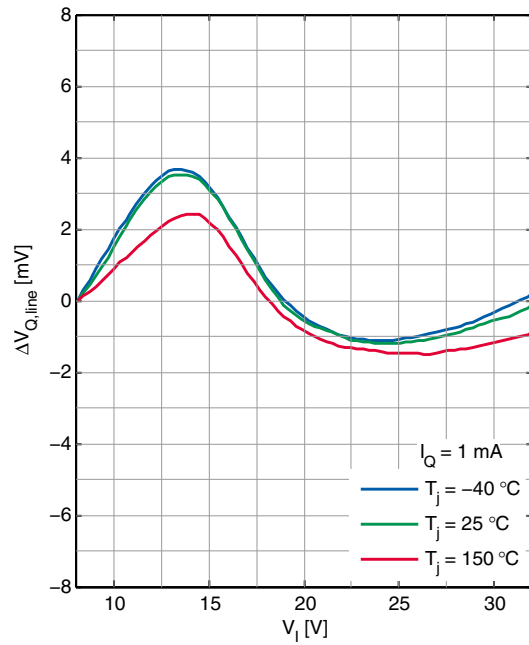

**Output Voltage  $V_Q$  versus Input Voltage  $V_I$  (3.3 V version)**

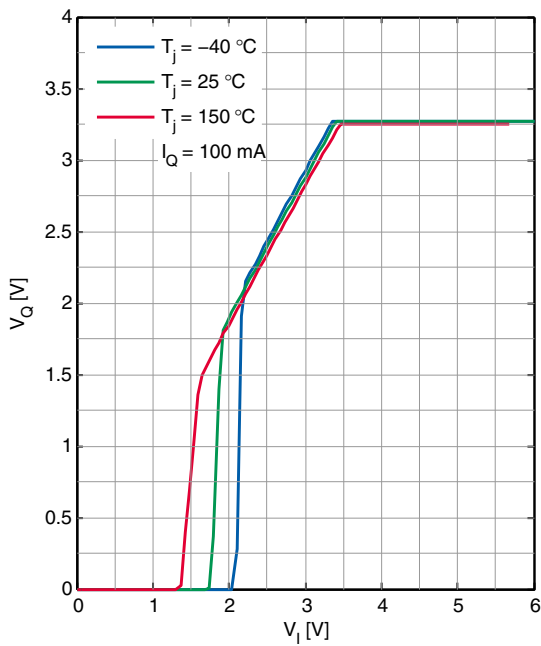

**Output Voltage  $V_Q$  versus Input Voltage  $V_I$  (5 V version)**

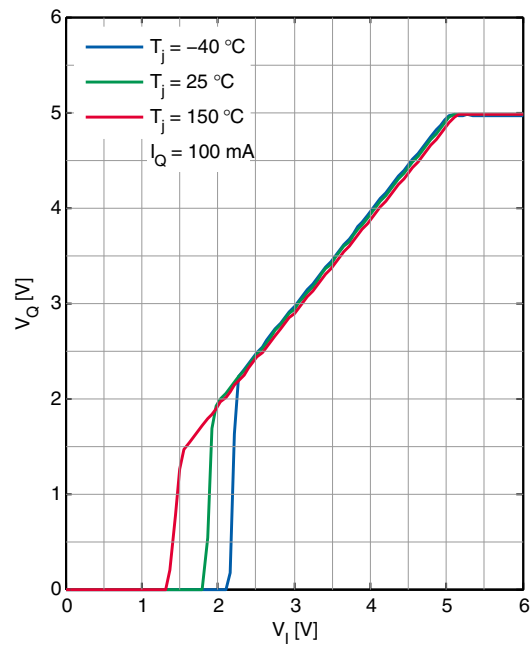

**Power Supply Ripple Rejection  $PSRR$  versus ripple frequency  $f$**

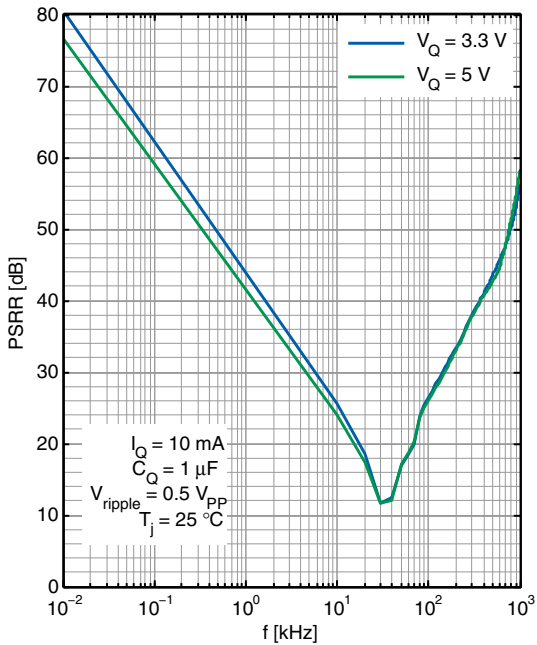

**Output Capacitor Series Resistor  $ESR(C_Q)$  versus Output Current  $I_Q$**

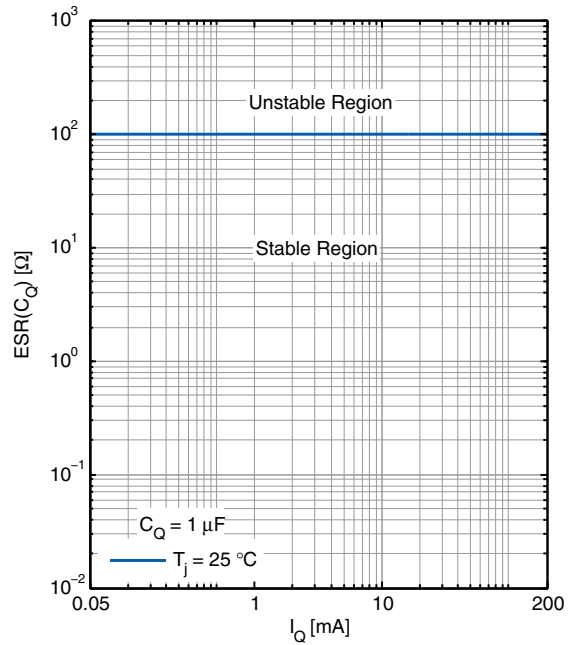

**Maximum Output Current  $I_{Q,max}$  versus Input Voltage  $V_I$**

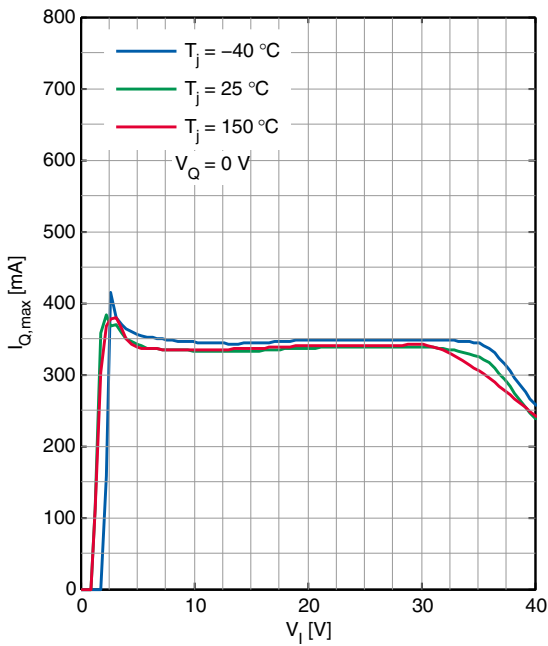

**Dropout Voltage  $V_{dr}$  versus Output Current  $I_Q$**

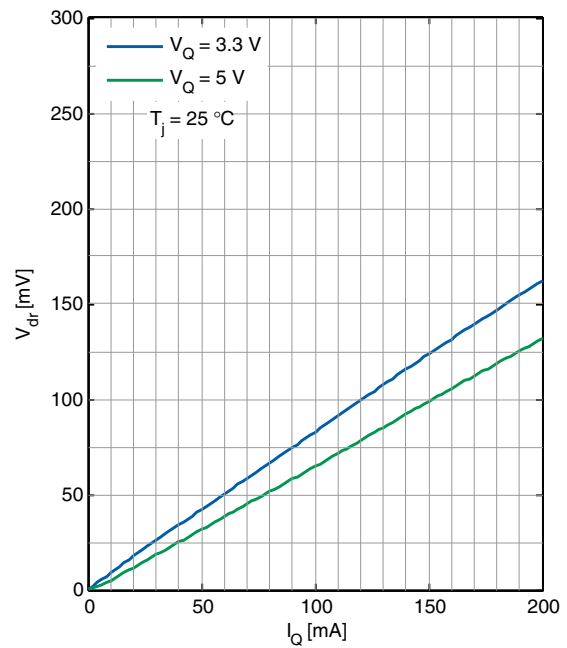

### 5.3 Current Consumption

**Table 6 Electrical Characteristics Current Consumption**
 $T_j = -40\text{ °C to }+150\text{ °C}$ ,  $V_I = 13.5\text{ V}$  (unless otherwise specified)

 Typical values are given at  $T_j = 25\text{ °C}$ 

Conditions of other pins: DT = GND

Parameter	Symbol	Values			Unit	Note / Test Condition	Number
		Min.	Typ.	Max.			
Current Consumption $I_q = I_I$	$I_{q,off}$	–	1.3	5	$\mu\text{A}$	$V_{EN} = 0\text{ V}; T_j < 105\text{ °C}$	P_5.3.1
Current Consumption $I_q = I_I$	$I_{q,off}$	–	–	8	$\mu\text{A}$	$V_{EN} = 0.4\text{ V}; T_j < 125\text{ °C}$	P_5.3.3
Current Consumption $I_q = I_I - I_Q$	$I_q$	–	40	52	$\mu\text{A}$	$I_Q = 0.05\text{ mA}$ $T_j = 25\text{ °C}$	P_5.3.4
Current Consumption $I_q = I_I - I_Q$	$I_q$	–	62	77	$\mu\text{A}$	$I_Q = 0.05\text{ mA}$ $T_j < 125\text{ °C}$	P_5.3.7
Current Consumption $I_q = I_I - I_Q$	$I_q$	–	62	80	$\mu\text{A}$	<sup>1)</sup> $I_Q = 200\text{ mA}$ $T_j < 125\text{ °C}$	P_5.3.9

1) Not subject to production test, specified by design



## 5.4 Typical Performance Characteristics Current Consumption

### Typical Performance Characteristics

Current Consumption  $I_q$  versus Output Current  $I_Q$

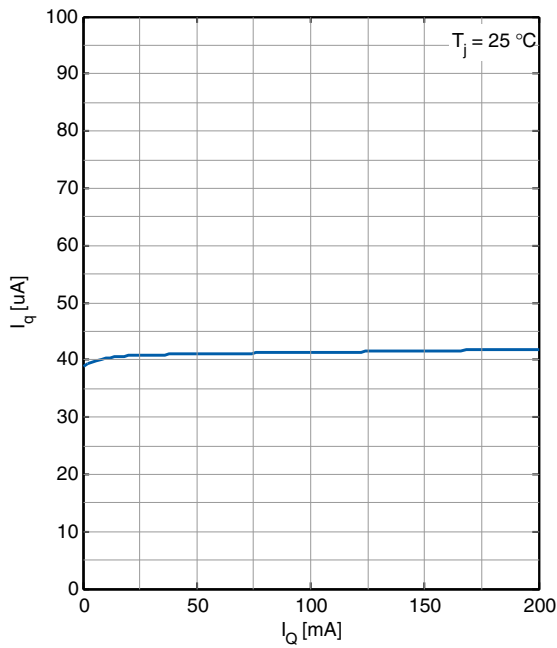

Current Consumption  $I_q$  versus Input Voltage  $V_I$

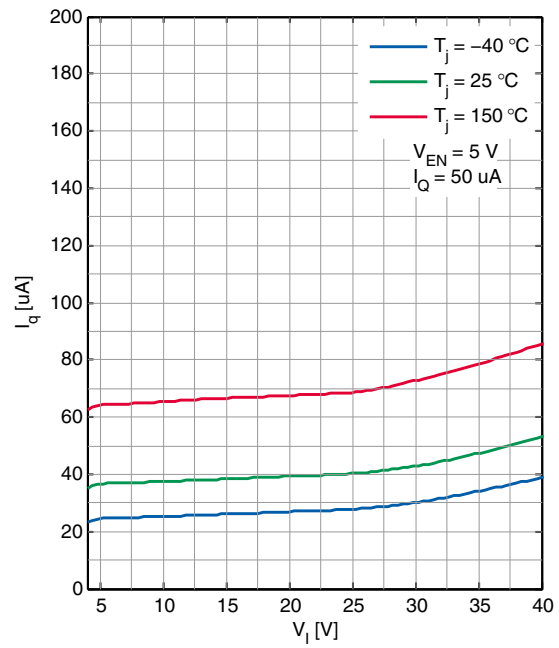

## 5.5 Enable

The TLS820D0 can be switched on and off by the Enable feature: Connect a HIGH level as specified below (e.g. the battery voltage) to pin EN to enable the device; connect a LOW level as specified below (e.g. GND) to shut it down. The enable has a built in hysteresis to avoid toggling between ON/OFF state, if signals with slow slopes are applied to the EN input.

**Table 7 Electrical Characteristics Enable**

$T_j = -40\text{ °C}$  to  $+150\text{ °C}$ ,  $V_i = 13.5\text{ V}$ , all voltages with respect to ground (unless otherwise specified)  
 Typical values are given at  $T_j = 25\text{ °C}$

Parameter	Symbol	Values			Unit	Note / Test Condition	Number
		Min.	Typ.	Max.			
High Level Input Voltage	$V_{EN,H}$	2	–	–	V	$V_Q$ settled	P_5.5.1
Low Level Input Voltage	$V_{EN,L}$	–	–	0.8	V	$V_Q \leq 0.1\text{ V}$	P_5.5.2
Enable Threshold Hysteresis	$V_{EN,Hy}$	100	–	–	mV	–	P_5.5.3
High Level Input Current	$I_{EN,H}$	–	–	3.5	$\mu\text{A}$	$V_{EN} = 3.3\text{ V}$	P_5.5.4
High Level Input Current	$I_{EN,H}$	–	–	22	$\mu\text{A}$	$V_{EN} \leq 18\text{ V}$	P_5.5.6
Enable internal pull-down resistor	$R_{EN}$	0.95	1.5	2.6	M $\Omega$	–	P_5.5.7

## 5.6 Typical Performance Characteristics Enable

### Typical Performance Characteristics

**Input Current  $I_{IN}$  versus Input Voltage  $V_{IN}$  (condition:  $V_{EN} = 0V$ )**

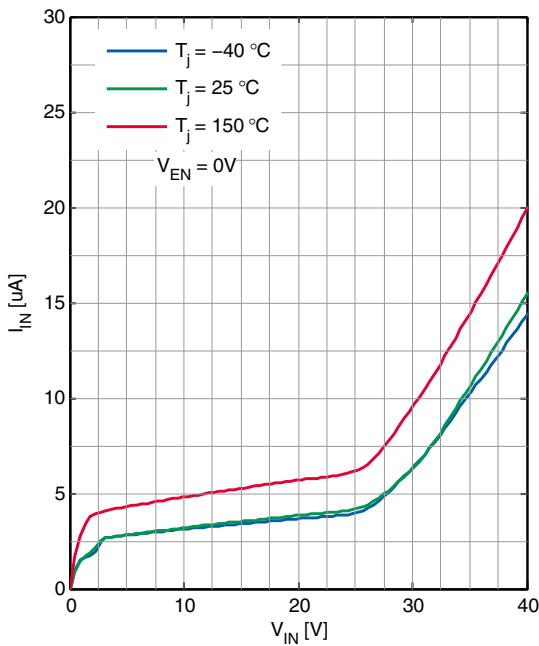

**Enabled Input Current  $I_{EN}$  versus Enabled Input Voltage  $V_{EN}$**

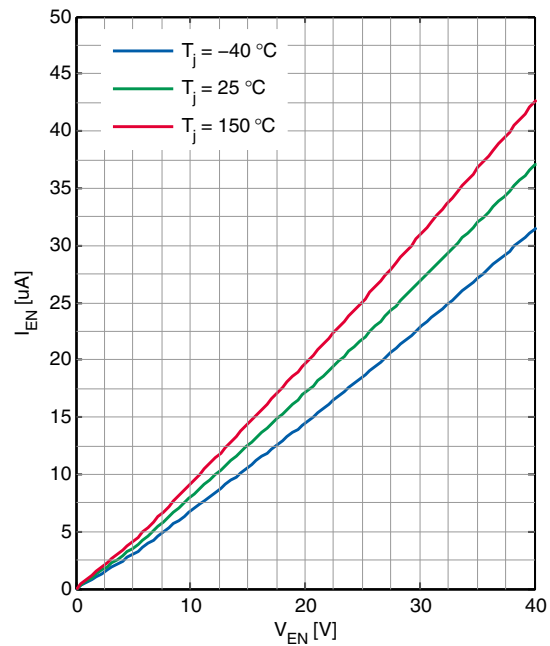

**Output Voltage  $V_Q$  versus time (EN switched ON, 5 V version)**

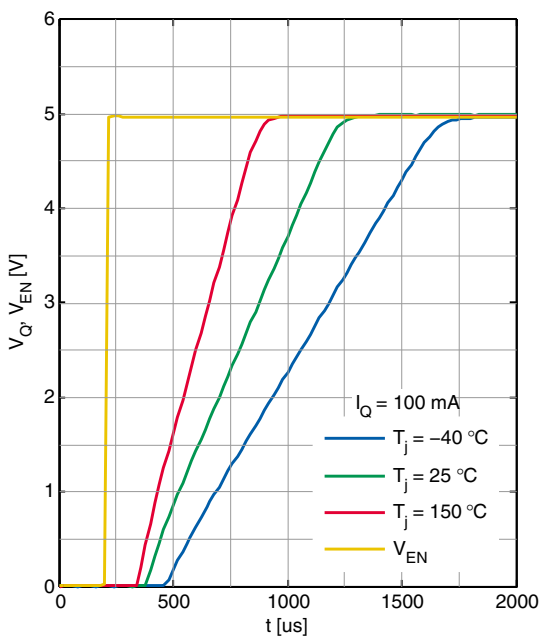

**Output Voltage  $V_Q$  versus time (EN switched ON, 3.3 V version)**

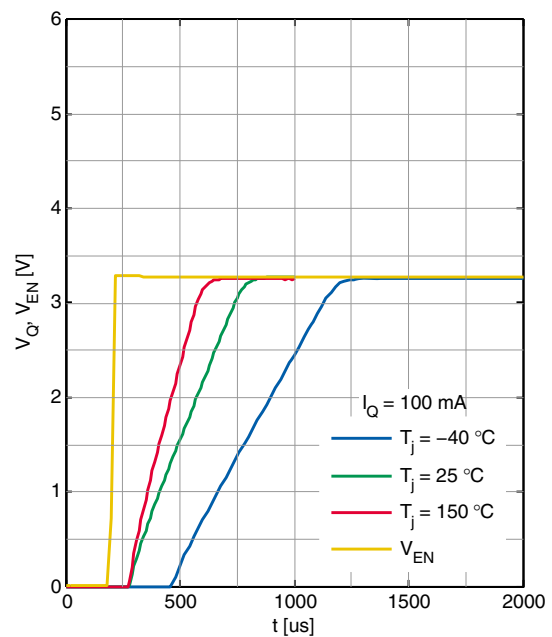

### 5.7 Reset

The TLS820D0's output voltage is supervised by the Reset feature, including Undervoltage Reset, delayed Reset at Power-On and an adjustable Reset Threshold.

The Undervoltage Reset function sets the pin RO to LOW, in case  $V_Q$  is falling for any reason below the Reset Threshold  $V_{RT,low}$ .

When the regulator is powered on, the pin RO is held at LOW for the duration of the Power-On Reset Delay Time  $t_{rd}$ .

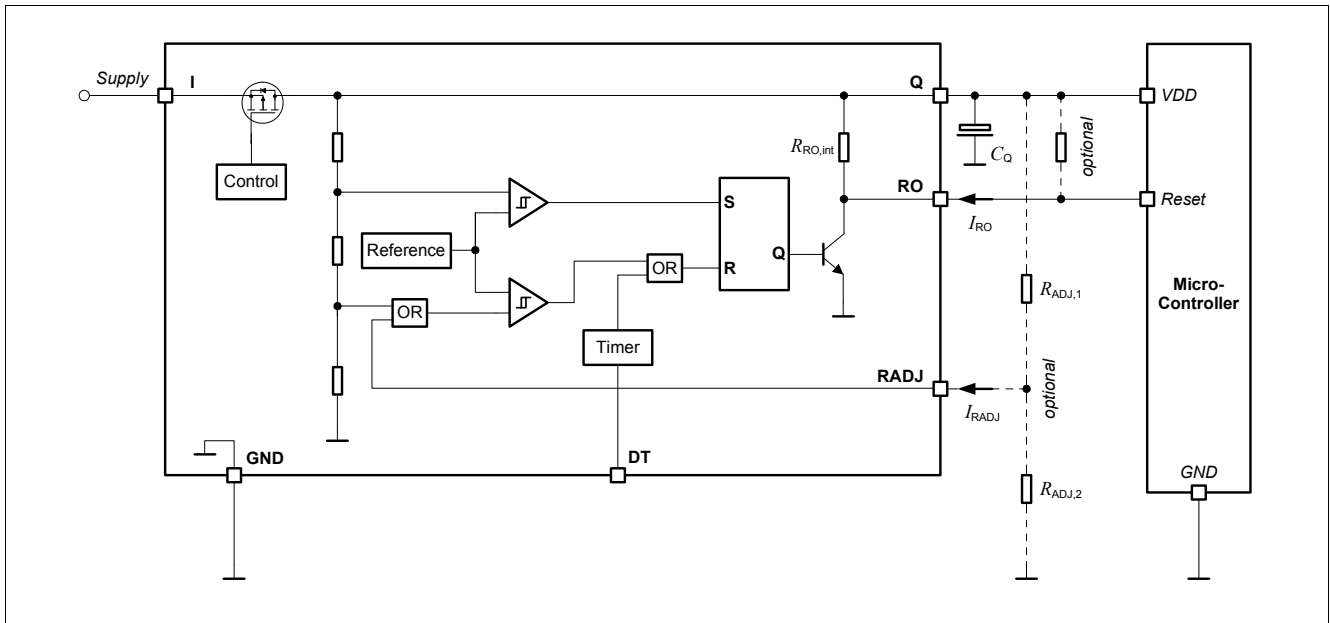

Figure 6 Block Diagram Reset Circuit

#### Reset Delay Time

The pin DT is used to set the desired Reset Delay Time  $t_{rd}$ . Connect this pin either to GND or Q to select the timing according to Table 8.

Table 8 Reset DelayTime Selection

DT connected to	$t_{rd}$
GND	16.5 ms
Q	8.5 ms

#### Power-On Reset Delay Time

The power-on reset delay time is defined by the parameter  $t_{rd}$  and allows a microcontroller and oscillator to start up. This delay time is the time period from exceeding the upper reset switching threshold  $V_{RT,high}$  until the reset is released by switching the reset output "RO" from "LOW" to "HIGH".

#### Undervoltage Reset Delay Time

Unlike the power-on reset delay time, the undervoltage reset delay time is defined by the parameter  $t_{rd}$  and considers an output undervoltage event where the output voltage  $V_Q$  trigger the  $V_{RT,low}$  threshold.

#### Reset Blanking Time

The reset blanking time  $t_{tr,blank}$  avoids that short undervoltage spikes trigger an unwanted reset "low" signal.

### Reset Reaction Time

In case the output voltage of the regulator drops below the output undervoltage lower reset threshold  $V_{RT,low}$ , the reset output "RO" is set to low, after the delay of the internal reset reaction time  $t_{rr,int}$ . The reset blanking time  $t_{rr,blank}$  is part of the reset reaction time  $t_{rr,int}$ .

### Reset Output "RO"

The reset output "RO" is an open collector output with an integrated pull-up resistor. In case a lower-ohmic "RO" signal is desired, an external pull-up resistor can be connected to the output "Q". Since the maximum "RO" sink current is limited, the minimum value of the optional external resistor " $R_{RO,ext}$ " is given in [Table "Reset Output RO" on Page 23](#).

### Reset Output "RO" Low for $V_Q \geq 1$ V

In case of an undervoltage reset condition reset output "RO" is held "low" for  $V_Q \geq 1$  V, even if the input "I" is not supplied and the voltage  $V_I$  drops below 1 V. This is achieved by supplying the reset circuit from the output capacitor.

### Reset Adjust Function

The undervoltage reset switching threshold can be adjusted according to the application's needs by connecting an external voltage divider ( $R_{ADJ,1}$ ,  $R_{ADJ,2}$ ) at pin "RADJ". For selecting the default threshold connect pin "RADJ" to GND. The reset adjustment range for the TLS820D0ELV50 is given in [Reset Threshold Adjustment Range](#). The reset adjustment range for the TLS820D0ELV33 is given in [Reset Threshold Adjustment Range](#).

When dimensioning the voltage divider, take into consideration that there will be an additional current constantly flowing through the resistors.

With a voltage divider connected, the reset switching threshold  $V_{RT,new}$  is calculated as follows (neglecting the Reset Adjust Pin Current  $I_{RADJ}$ ):

$$V_{RT,lo,new} = V_{RADJ,th} \times (R_{ADJ,1} + R_{ADJ,2}) / R_{ADJ,2} \quad (1)$$

with

- $V_{RT,lo,new}$ : Desired undervoltage reset switching threshold.
- $R_{ADJ,1}$ ,  $R_{ADJ,2}$ : Resistors of the external voltage divider, see [Figure 6](#).
- $V_{RADJ,th}$ : Reset adjust switching threshold given in [Reset Adjustment Switching Threshold](#).

Block Description and Electrical Characteristics

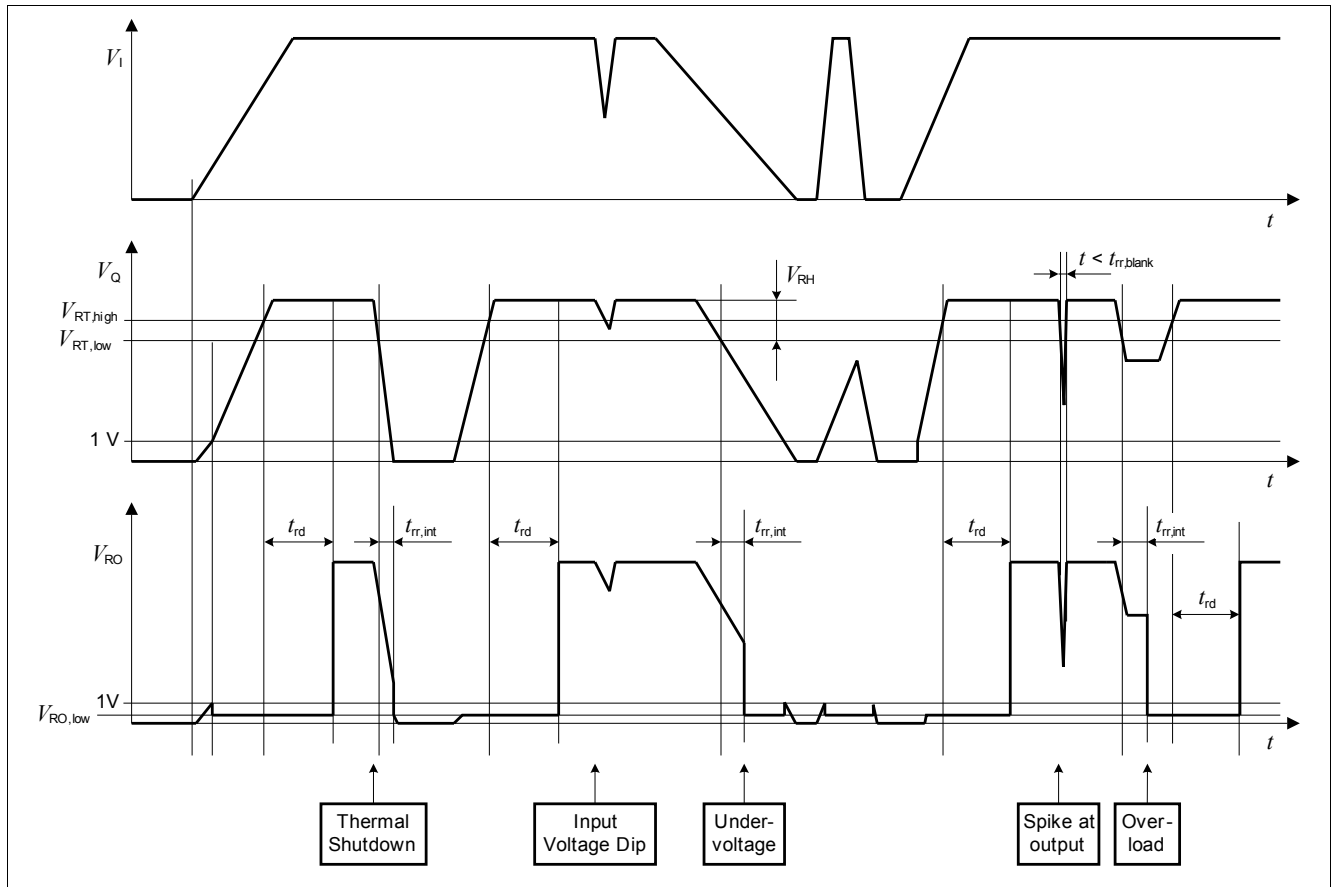

Figure 7 Typical Timing Diagram Reset

**Table 9 Electrical Characteristics Reset**

$T_j = -40\text{ °C}$  to  $+150\text{ °C}$ ,  $V_I = 13.5\text{ V}$ , all voltages with respect to ground (unless otherwise specified)  
 Typical values are given at  $T_j = 25\text{ °C}$

Parameter	Symbol	Values			Unit	Note / Test Condition	Number
		Min.	Typ.	Max.			
<b>Output Undervoltage Reset 5V Version only</b>							
Output Undervoltage Reset Upper Switching Threshold	$V_{RT,high}$	4.6	4.7	4.8	V	$V_Q$ increasing	P_5.7.1
Output Undervoltage Reset Lower Switching Threshold - Default	$V_{RT,low}$	4.5	4.6	4.7	V	$V_Q$ decreasing RADJ = GND	P_5.7.2
Output Undervoltage Reset Switching Hysteresis	$V_{RT,hy}$	60	100	–	mV	RADJ connected to GND	P_5.7.3
Output Undervoltage Reset Headroom $V_Q - V_{RT}$	$V_{RH}$	200	400	–	mV	RADJ = GND	P_5.7.4
<b>Output Undervoltage Reset 3V3 Version only</b>							
Output Undervoltage Reset Upper Switching Threshold	$V_{RT,high}$	3.08	3.15	3.22	V	$V_Q$ increasing	P_5.7.5
Output Undervoltage Reset Lower Switching Threshold - Default	$V_{RT,low}$	3.0	3.05	3.13	V	$V_Q$ decreasing RADJ = GND	P_5.7.6
Output Undervoltage Reset Switching Hysteresis	$V_{RT,hy}$	60	100	–	mV	RADJ connected to GND	P_5.7.7
Output Undervoltage Reset Headroom $V_Q - V_{RT}$	$V_{RH}$	100	250	–	mV	RADJ = GND	P_5.7.8
<b>Reset Threshold Adjustment</b>							
Reset Adjustment Switching Threshold	$V_{RADJ,th}$	1.15	1.20	1.25	V	–	P_5.7.9
Reset Threshold Adjustment Range	$V_{RT,range}$	2.5	–	4.4	V	for $V_{Q,nom} = 5\text{ V}$	P_5.7.10
Reset Threshold Adjustment Range	$V_{RT,range}$	2.5	–	2.9	V	for $V_{Q,nom} = 3.3\text{ V}$	P_5.7.11
<b>Reset Output RO</b>							
Reset Output Low Voltage	$V_{RO,low}$	–	0.2	0.4	V	$1\text{ V} \leq V_Q \leq V_{RT}$ ; $R_{RO} \geq 5.1\text{ k}\Omega$	P_5.7.12
Reset Output Internal Pull-Up Resistor	$R_{RO,int}$	13	20	36	k $\Omega$	internally connected to Q	P_5.7.13
Reset Output External Pull-up Resistor to $V_Q$	$R_{RO,ext}$	5.1	–	–	k $\Omega$	$1\text{ V} \leq V_Q \leq V_{RT}$ ; $V_{RO} \leq 0.4\text{ V}$	P_5.7.14
<b>Reset Delay Timing</b>							
Reset Delay Time	$t_{rd,slow}$	13.2	16.5	19.8	ms	DT connected to GND	P_5.7.20
Reset Delay Time	$t_{rd,fast}$	6.8	8.5	10.2	ms	DT connected to Q	P_5.7.21
Reset blanking time	$t_{rr,blank}$	–	6	–	$\mu\text{s}$	<sup>1)</sup> for $V_{Q,nom} = 3.3\text{ V}$	P_5.7.22
Reset blanking time	$t_{rr,blank}$	–	7	–	$\mu\text{s}$	<sup>2)</sup> for $V_{Q,nom} = 5\text{ V}$	P_5.7.46
Internal Reset Reaction Time	$t_{rr,int}$	–	7	20	$\mu\text{s}$	for $V_{Q,nom} = 3.3\text{ V}$	P_5.7.23
Internal Reset Reaction Time	$t_{rr,int}$	–	10	33	$\mu\text{s}$	for $V_{Q,nom} = 5\text{ V}$	P_5.7.36
<b>Reset Delay Input DT</b>							
Delay Input DT High Signal Valid	$V_{DT,H}$	2.0	–	–	V	–	P_5.7.29

## Block Description and Electrical Characteristics

**Table 9 Electrical Characteristics Reset (cont'd)**

$T_j = -40\text{ °C}$  to  $+150\text{ °C}$ ,  $V_i = 13.5\text{ V}$ , all voltages with respect to ground (unless otherwise specified)  
 Typical values are given at  $T_j = 25\text{ °C}$

Parameter	Symbol	Values			Unit	Note / Test Condition	Number
		Min.	Typ.	Max.			
Delay Input DT Low Signal Valid	$V_{DT,L}$	–	–	0.80	V		P_5.7.30
Delay Input DT Signal Slew Rate	$dV_{DT}/dt$	1	–	–	V/ $\mu$ s	$V_{DT,L} < V_{DT} < V_{DT,H}$	P_5.7.35
High Level Input Current	$I_{DT,H}$	–	–	3.5	$\mu$ A	$V_{DT} = 3.3\text{ V}$	P_5.7.32
Delay Input DT internal pull-down resistor	$R_{DT}$	0.9	1.5	2.6	M $\Omega$		P_5.7.33

- 1) Not subject to production test, specified by design.
- 2) Not subject to production test, specified by design.



## 5.8 Typical Performance Characteristics Reset

### Typical Performance Characteristics

Undervoltage Reset Threshold  $V_{RT}$  versus Junction Temperature  $T_j$  (3.3 V version)

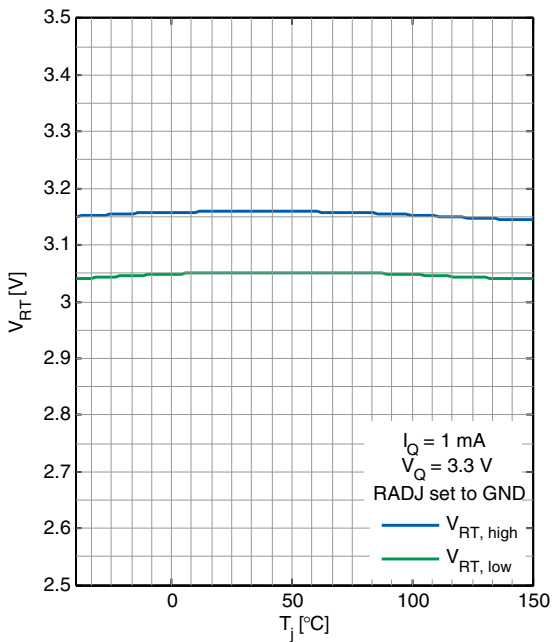

Undervoltage Reset Threshold  $V_{RT}$  versus Junction Temperature  $T_j$  (5 V version)

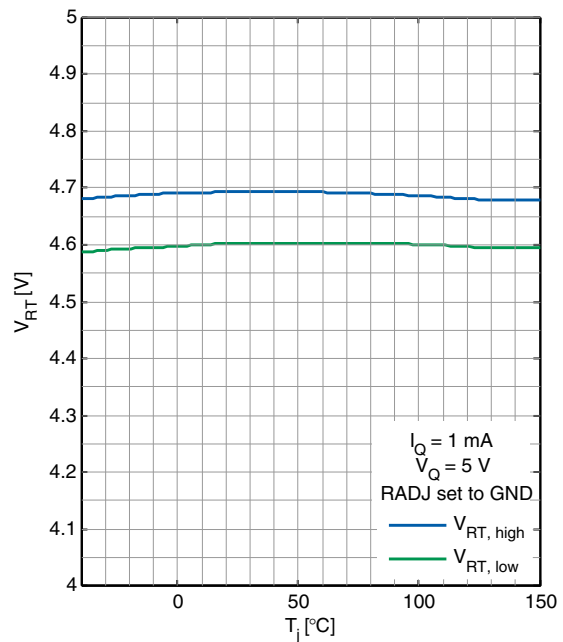

Power On Reset Delay Time  $t_{rd}$  versus Junction Temperature  $T_j$

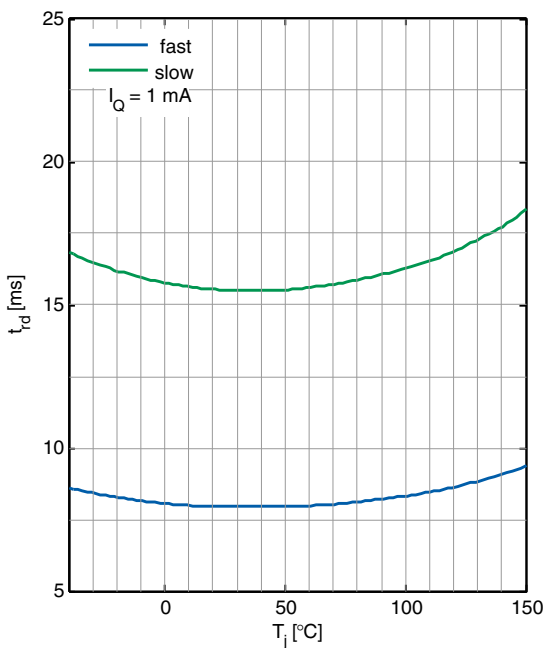

Internal Reset Reaction Time  $t_{rr,int}$  versus Junction Temperature  $T_j$

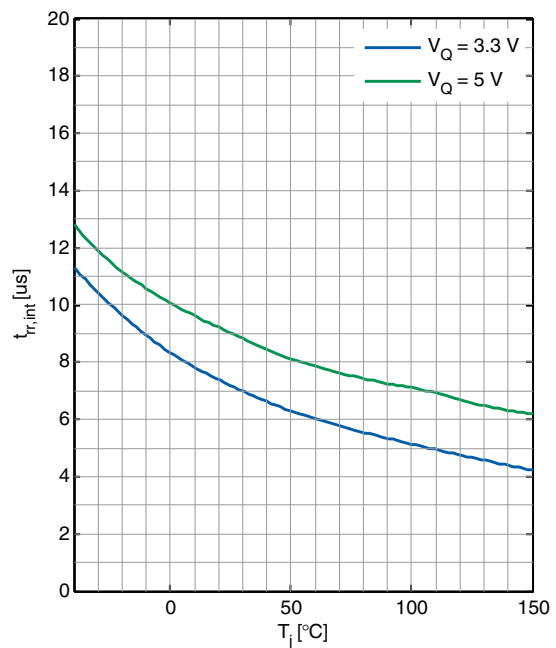

## 6 Application Information

### 6.1 Application Diagram

Note: The following information is given as a hint for the implementation of the device only and shall not be regarded as a description or warranty of a certain functionality, condition or quality of the device.

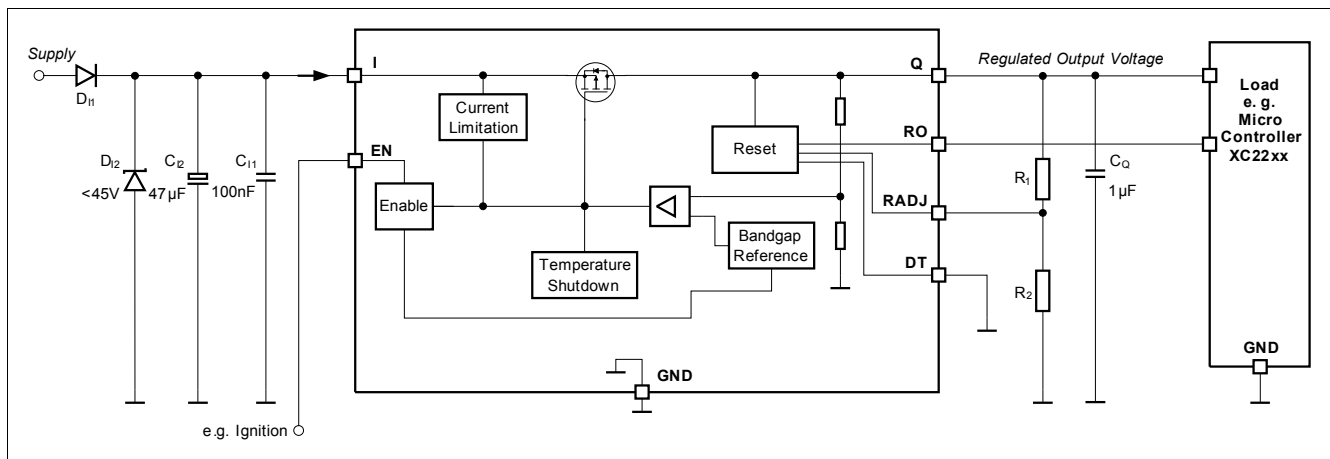

Figure 8 Application Diagram

Note: This is a very simplified example of an application circuit. The function must be verified in the real application.

### 6.2 Selection of External Components

#### 6.2.1 Input Pin

The typical input circuitry for a linear voltage regulator is shown in the application diagram above.

A ceramic capacitor at the input, in the range of 100 nF to 470 nF, is recommended to filter out the high frequency disturbances imposed by the line e.g. ISO pulses 3a/b. This capacitor must be placed very close to the input pin of the linear voltage regulator on the PCB.

An aluminum electrolytic capacitor in the range of 10 µF to 470 µF is recommended as an input buffer to smooth out high energy pulses, such as ISO pulse 2a. This capacitor should be placed close to the input pin of the linear voltage regulator on the PCB.

An overvoltage suppressor diode can be used to further suppress any high voltage beyond the maximum rating of the linear voltage regulator and protect the device against any damage due to over-voltage.

The external components at the input are not mandatory for the operation of the voltage regulator, but they are recommended in case of possible external disturbances.

#### 6.2.2 Output Pin

An output capacitor is mandatory for the stability of linear voltage regulators.

The requirement to the output capacitor is given in [“Functional Range” on Page 8](#). The graph [“Output Capacitor Series Resistor ESR\(CQ\) versus Output Current IQ” on Page 15](#) shows the stable operation range of the device.

TLS820D0 is designed to be also stable with low ESR capacitors. According to the automotive requirements, ceramic capacitors with X5R or X7R dielectrics are recommended.

The output capacitor should be placed as close as possible to the regulator's output and GND pins and on the same side of the PCB as the regulator itself.

In case of rapid transients of input voltage or load current, the capacitance should be dimensioned in accordance and verified in the real application that the output stability requirements are fulfilled.

### 6.3 Thermal Considerations

Knowing the input voltage, the output voltage and the load profile of the application, the total power dissipation can be calculated:

$$P_D = (V_I - V_Q) \times I_Q + V_I \times I_q \quad (2)$$

with

- $P_D$ : continuous power dissipation
- $V_I$ : input voltage
- $V_Q$ : output voltage
- $I_Q$ : output current
- $I_q$ : quiescent current

The maximum acceptable thermal resistance  $R_{thJA}$  can then be calculated:

$$R_{thJA,max} = (T_{j,max} - T_a) / P_D \quad (3)$$

with

- $T_{j,max}$ : maximum allowed junction temperature
- $T_a$ : ambient temperature

Based on the above calculation the proper PCB type and the necessary heat sink area can be determined with reference to the specification in [“Thermal Resistance” on Page 9](#).

#### Example

Application conditions:

$$V_I = 13.5 \text{ V}$$

$$V_Q = 5 \text{ V}$$

$$I_Q = 150 \text{ mA}$$

$$T_a = 85 \text{ °C}$$

Calculation of  $R_{thJA,max}$ :

$$\begin{aligned} P_D &= (V_I - V_Q) \times I_Q + V_I \times I_q && (V_I \times I_q \text{ can be neglected because of very low } I_q) \\ &= (13.5 \text{ V} - 5 \text{ V}) \times 150 \text{ mA} \\ &= 1.275 \text{ W} \end{aligned}$$

$$\begin{aligned} R_{thJA,max} &= (T_{j,max} - T_a) / P_D \\ &= (150 \text{ °C} - 85 \text{ °C}) / 1.275 \text{ W} = 50.98 \text{ K/W} \end{aligned}$$

As a result, the PCB design must ensure a thermal resistance  $R_{thJA}$  lower than 50.98 K/W. According to **“Thermal Resistance” on Page 9**, at least 600 mm<sup>2</sup> heatsink area is needed on the FR4 1s0p PCB, or the FR4 2s2p board can be used to ensure a proper cooling for the TLS820D0 in PG-SSOP-14 package.

#### 6.4 Reverse Polarity Protection

TLS820D0 is not self protected against reverse polarity faults and must be protected by external components against negative supply voltage. An external reverse polarity diode is needed. The absolute maximum ratings of the device as specified in **“Absolute Maximum Ratings” on Page 7** must be kept.

#### 6.5 Further Application Information

- For further information you may contact <http://www.infineon.com/>

## 7 Package Outlines

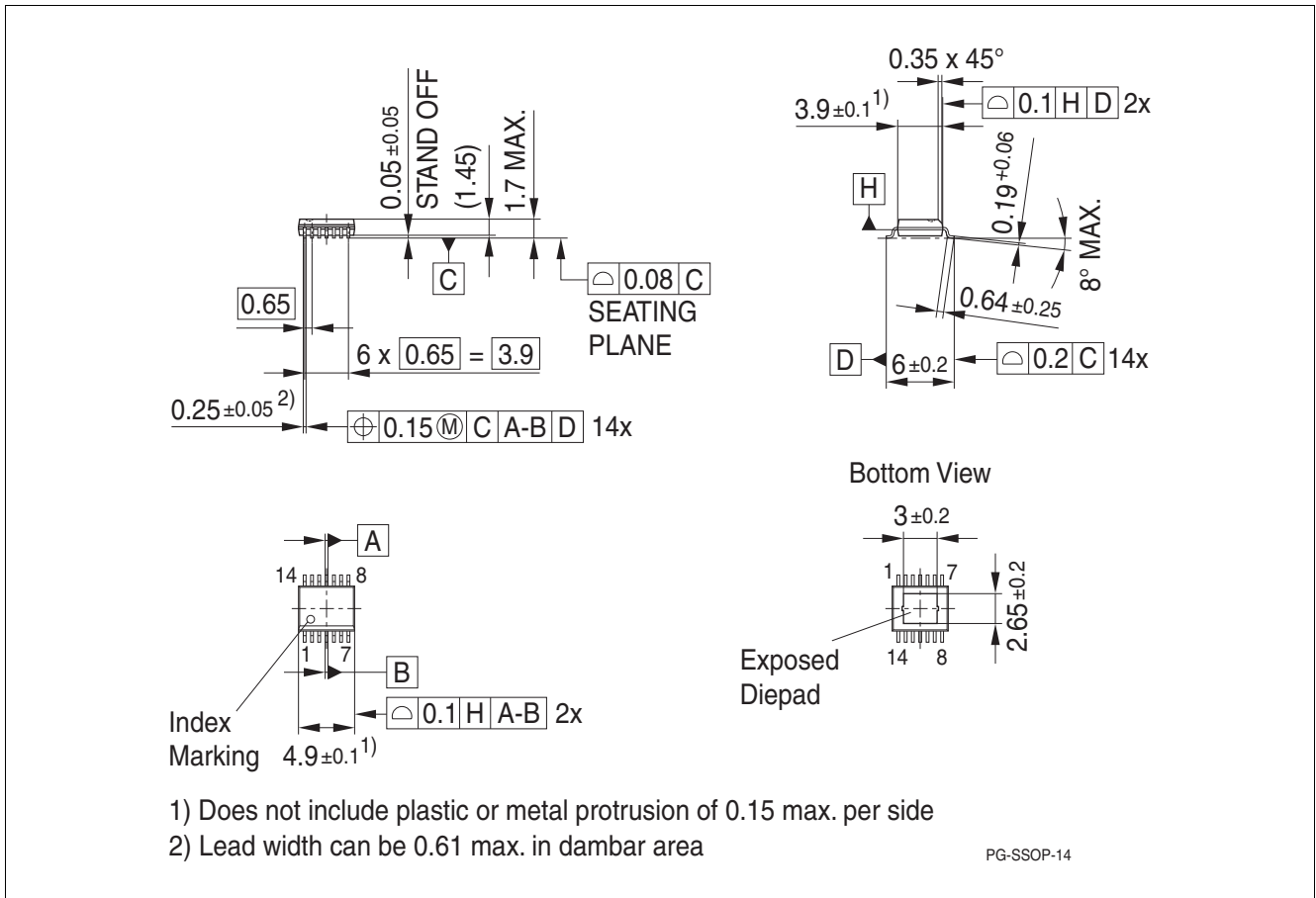

Figure 9 PG-SSOP-14

### Green Product (RoHS compliant)

To meet the world-wide customer requirements for environmentally friendly products and to be compliant with government regulations the device is available as a green product. Green products are RoHS-Compliant (i.e Pb-free finish on leads and suitable for Pb-free soldering according to IPC/JEDEC J-STD-020).

For further information on alternative packages, please visit our website:  
<http://www.infineon.com/packages>.

Dimensions in mm

## 8 Revision History

Revision	Date	Changes
1.0	2016-02-08	Data Sheet - Initial version

#### Trademarks of Infineon Technologies AG

AURIX™, C166™, CanPAK™, CIPOS™, CIPURSE™, CoolMOS™, CoolSET™, CORECONTROL™, CROSSAVE™, DAVE™, DI-POL™, EasyPIM™, EconoBRIDGE™, EconoDUAL™, EconoPIM™, EconoPACK™, EiceDRIVER™, eupec™, FCOS™, HITFET™, HybridPACK™, I<sup>2</sup>RF™, ISOFACE™, IsoPACK™, LITIX™, MIPAQ™, ModSTACK™, my-d™, NovalithIC™, OptiMOS™, ORIGA™, POWERCODE™, PRIMARION™, PrimePACK™, PrimeSTACK™, PRO-SIL™, PROFET™, RASIC™, ReverSave™, SatRIC™, SIEGET™, SINDRION™, SIPMOS™, SmartLEWIS™, SPOC™, SOLID FLASH™, TEMPFET™, thinQ™, TRENCHSTOP™, TriCore™.

#### Other Trademarks

Advance Design System™ (ADS) of Agilent Technologies, AMBA™, ARM™, MULTI-ICE™, KEIL™, PRIMECELL™, REALVIEW™, THUMB™,  $\mu$ Vision™ of ARM Limited, UK. AUTOSAR™ is licensed by AUTOSAR development partnership. Bluetooth™ of Bluetooth SIG Inc. CAT-iq™ of DECT Forum. COLOSSUS™, FirstGPS™ of Trimble Navigation Ltd. EMV™ of EMVCo, LLC (Visa Holdings Inc.). EPCOS™ of Epcos AG. FLEXGO™ of Microsoft Corporation. FlexRay™ is licensed by FlexRay Consortium. HYPERTERMINAL™ of Hilgraeve Incorporated. IEC™ of Commission Electrotechnique Internationale. IrDA™ of Infrared Data Association Corporation. ISO™ of INTERNATIONAL ORGANIZATION FOR STANDARDIZATION. MATLAB™ of MathWorks, Inc. MAXIM™ of Maxim Integrated Products, Inc. MICROTEC™, NUCLEUS™ of Mentor Graphics Corporation. MIPI™ of MIPI Alliance, Inc. MIPS™ of MIPS Technologies, Inc., USA. muRata™ of MURATA MANUFACTURING CO., MICROWAVE OFFICE™ (MWO) of Applied Wave Research Inc., OmniVision™ of OmniVision Technologies, Inc. Openwave™ Openwave Systems Inc. RED HAT™ Red Hat, Inc. RFMD™ RF Micro Devices, Inc. SIRIUS™ of Sirius Satellite Radio Inc. SOLARIS™ of Sun Microsystems, Inc. SPANSION™ of Spansion LLC Ltd. Symbian™ of Symbian Software Limited. TAIYO YUDEN™ of Taiyo Yuden Co. TEAKLITE™ of CEVA, Inc. TEKTRONIX™ of Tektronix Inc. TOKO™ of TOKO KABUSHIKI KAISHA TA. UNIX™ of X/Open Company Limited. VERILOG™, PALLADIUM™ of Cadence Design Systems, Inc. VLYNQ™ of Texas Instruments Incorporated. VXWORKS™, WIND RIVER™ of WIND RIVER SYSTEMS, INC. ZETEX™ of Diodes Zetex Limited.

Last Trademarks Update 2011-11-11

[www.infineon.com](http://www.infineon.com)

Edition 2016-02-08

Published by

Infineon Technologies AG

81726 Munich, Germany

© 2016 Infineon Technologies AG.

All Rights Reserved.

Do you have a question about any aspect of this document?

Email: [erratum@infineon.com](mailto:erratum@infineon.com)

#### Legal Disclaimer

The information given in this document shall in no event be regarded as a guarantee of conditions or characteristics. With respect to any examples or hints given herein, any typical values stated herein and/or any information regarding the application of the device, Infineon Technologies hereby disclaims any and all warranties and liabilities of any kind, including without limitation, warranties of non-infringement of intellectual property rights of any third party.

#### Information

For further information on technology, delivery terms and conditions and prices, please contact the nearest Infineon Technologies Office ([www.infineon.com](http://www.infineon.com)).

#### Warnings

Due to technical requirements, components may contain dangerous substances. For information on the types in question, please contact the nearest Infineon Technologies Office. Infineon Technologies components may be used in life-support devices or systems only with the express written approval of Infineon Technologies, if a failure of such components can reasonably be expected to cause the failure of that life-support device or system or to affect the safety or effectiveness of that device or system. Life support devices or systems are intended to be implanted in the human body or to support and/or maintain and sustain and/or protect human life. If they fail, it is reasonable to assume that the health of the user or other persons may be endangered.

单击下面可查看定价，库存，交付和生命周期等信息

[>>Infineon\(英飞凌\)](#)