

TLx5012B 2go Evaluation Kit

About this document

Scope and purpose

This document describes the evaluation kit for the TLx5012B GMR based angle sensor.

The purpose of this document is to describe the software installation process and how to use the TLx5012B 2go Evaluation Kit.

Intended audience

This document is intended for anyone who wants to use the TLx5012B 2go Evaluation Kit.

Table of contents

	About this document	1
	Table of contents	2
1	General description	3
1.1	Assembly variants	4
1.2	Hardware description	5
2	Software installation	7
3	Evaluation Kit for GMR based angle sensors	11
3.1	Connection to PC and starting the application	11
3.2	SPI display	12
3.3	IIF display	13
3.4	PWM display	14
3.5	SPC display	15
3.6	Save File feature	16
3.7	RAM memory access	17
3.8	Soft fusing of protocols	18
3.9	Software & Firmware revision	19
3.10	User manual	20
4	Revision history	21

General description

1 General description

The TLx5012B 2go is a budget-priced evaluation kit to evaluate several derivatives of the Infineon TLx5012B GMR angle sensor:

- TLx5012B E1000: industrial version with IIF interface
- TLx5012B E1000: automotive version with IIF interface
- TLx5012B E5000: automotive version with PWM interface
- TLx5012B E9000: automotive version with SPC interface

All derivatives provide an additional SSC interface used for both reading the angle value and setting the internal registers of the sensor.

A mechanical rotation knob may be ordered independently from the hardware evaluation kit, providing magnetic stimulus to the sensor.

The evaluation kit includes a GUI software application that can be downloaded from the evaluation kit product page.

General description

1.1 Assembly variants

The TLx5012B 2go kit comes in 4 assembly variants while the support PCB is always the same. The sensor used may be one of 4 predefined: TLI5012b E1000, TLE5012b E1000, TLE5012b E5000 and TLE5012b E9000. The TLE5012b E3005 is not targeted by this evaluation kit.

The content of the evaluation kit is shown on the back of the delivery box with a check mark in one of the four boxes.

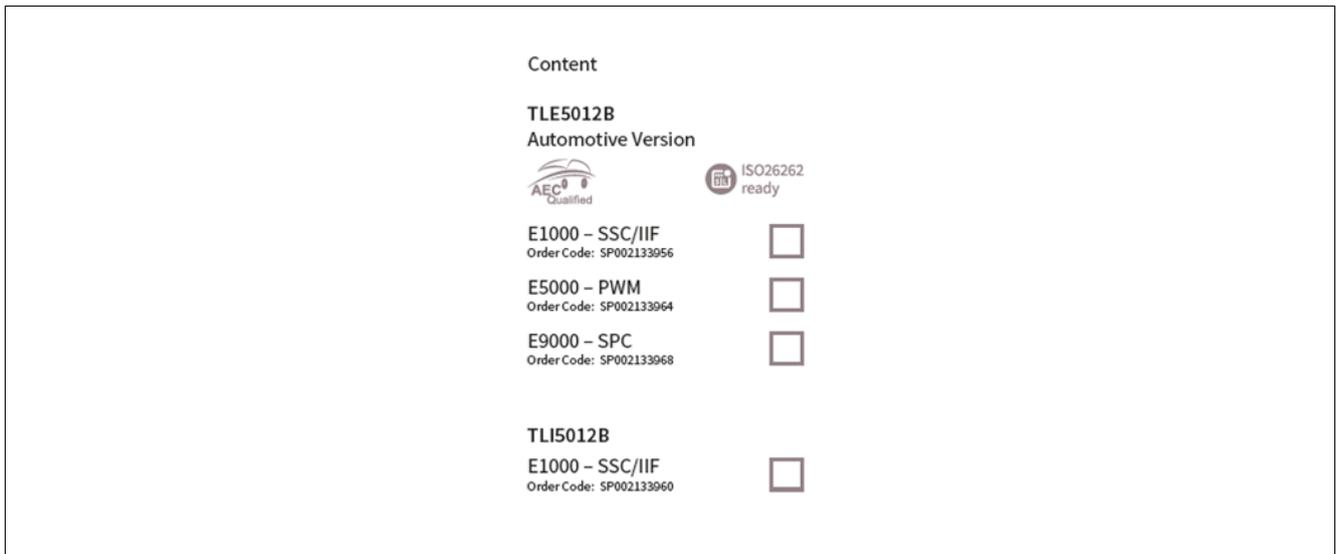

Figure 1 Assembly variants

The type of sensor can also be identified by checking the markings on the sensor package:

Table 1 Markings

Product type	Marking	Ordering Code	Package
TLE5012B E1000	012B1000	SP001166960	PG-DSO-8
TLE5012B E3005	012B3005	SP001166964	PG-DSO-8
TLE5012B E5000	012B5000	SP001166968	PG-DSO-8
TLE5012B E5020	012B5020	SP001166972	PG-DSO-8
TLE5012B E9000	012B9000	SP001166998	PG-DSO-8

General description

1.2 Hardware description

The evaluation kit hardware is built around the XMC1100 Infineon target microcontroller (4), ARM M0 based. In addition, the hardware includes an on-board debugger microcontroller (5) implemented with the Infineon XMC4200 running a SEGGER Jlink debugger.

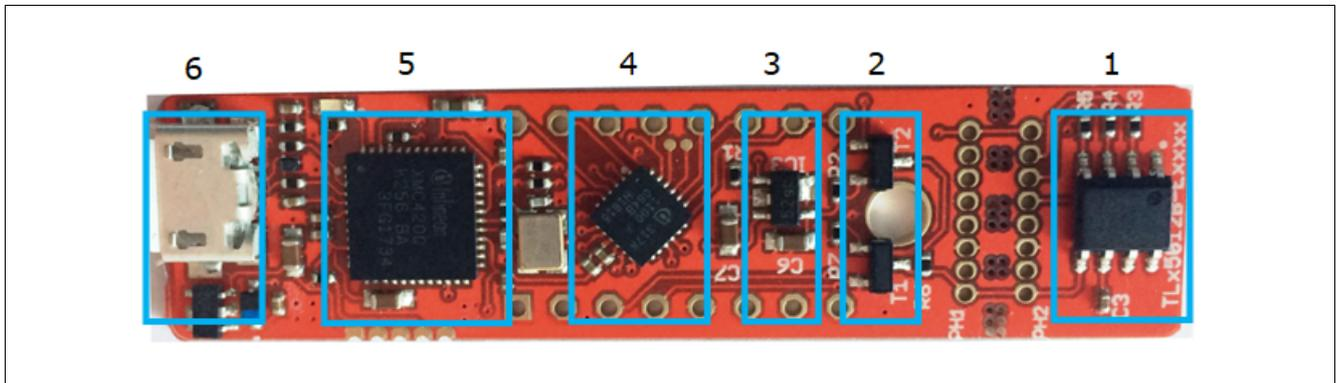

Figure 2 TLx5012B 2go evaluation hardware

The sensor supply is ensured by a TLE4250-2G tracker (3) dynamically enabled / disabled by the target microcontroller.

Two MOS transistors (2) - one PMOS and one NMOS - are being used for enabling a pull-up resistor (2.2 kΩ) and for pulling down the line for the SPC pulse generation. Both transistors are controlled by the XMC1100 target. The sensor (1) is placed on a break-apart region of the PCB so it can be removed and placed in a system. For the connection to the PC a micro-USB (6) to USB cable is required (not provided with the package).

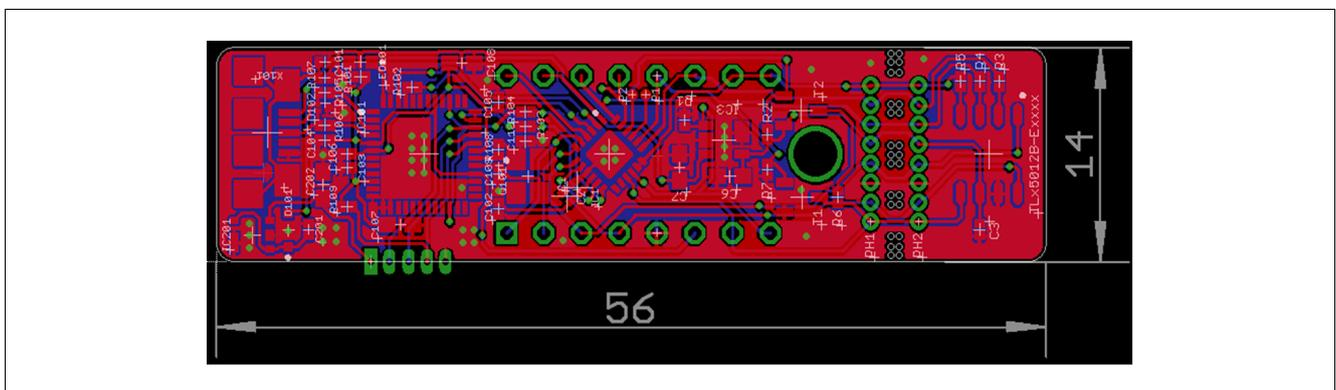

Figure 3 Hardware - board layout (top)

General description

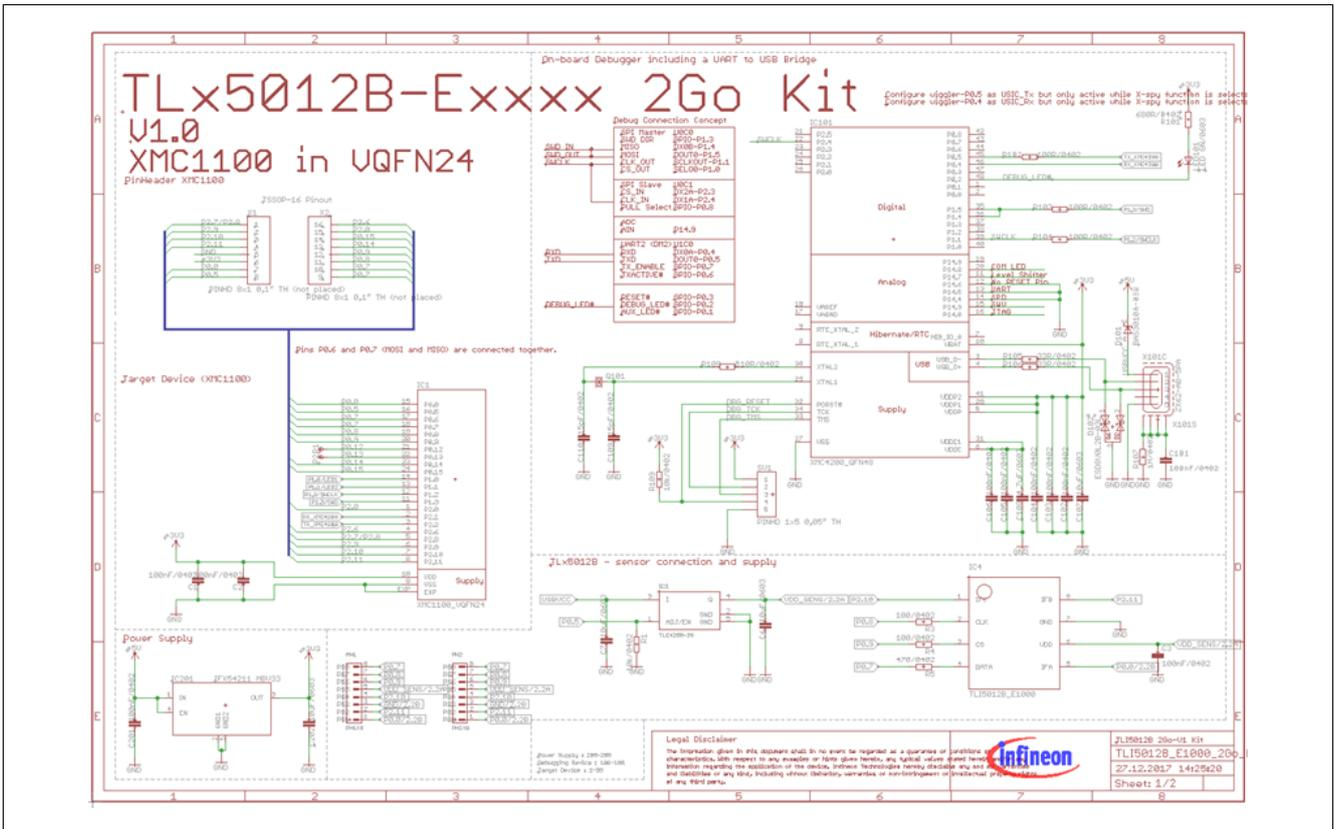

Figure 4 Hardware - schematic (part I)

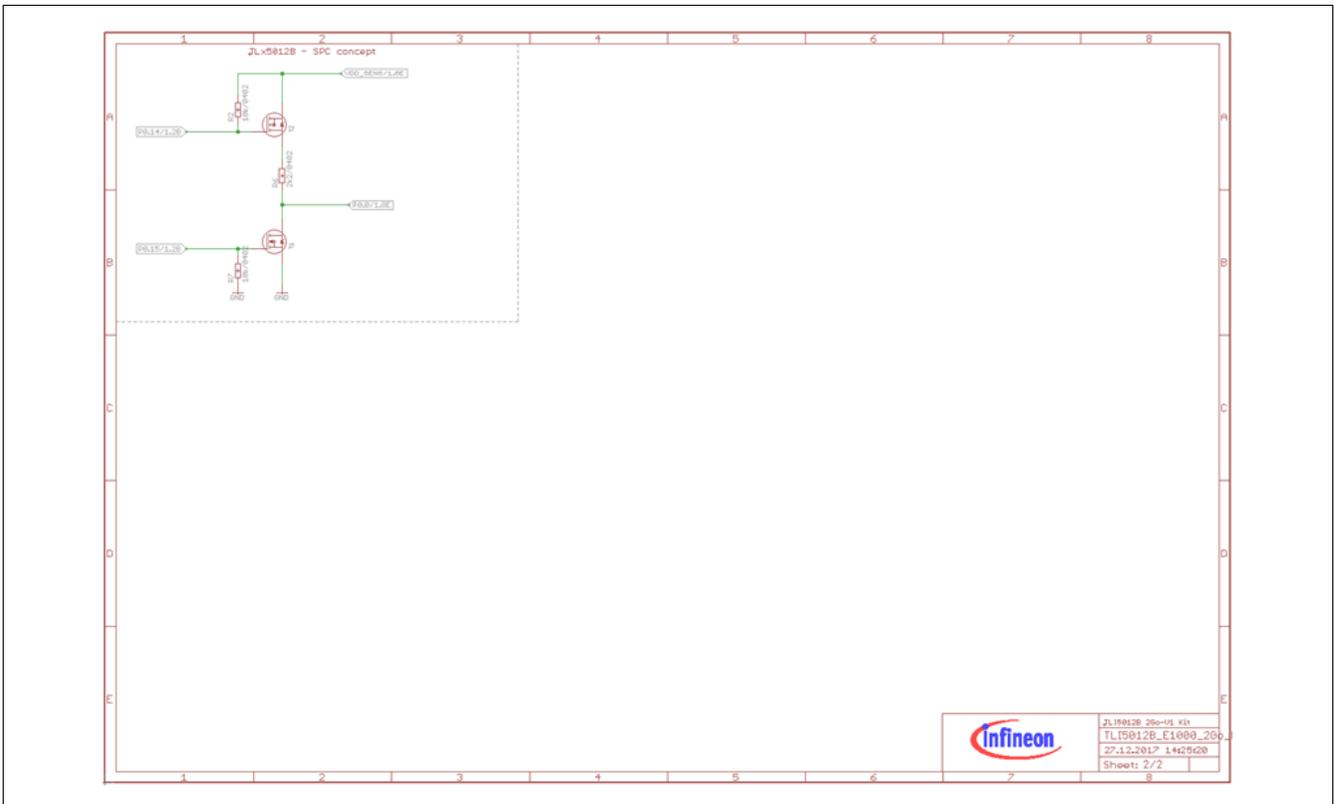

Figure 5 Hardware - schematic (part II)

Software installation

2 Software installation

Preparation

1. Download the TLx5012B 2go evaluation kit software from the Infineon Website (www.infineon.com/sensors2go).
2. Extract / unzip the downloaded package from the Infineon website.
3. Install the evaluation kit software by double clicking on the installer file. Please notice that administration rights are mandatory for a clean installation process.

Software installation - step 1

This is the installer entry point. Click **Next** to go forward with the process.

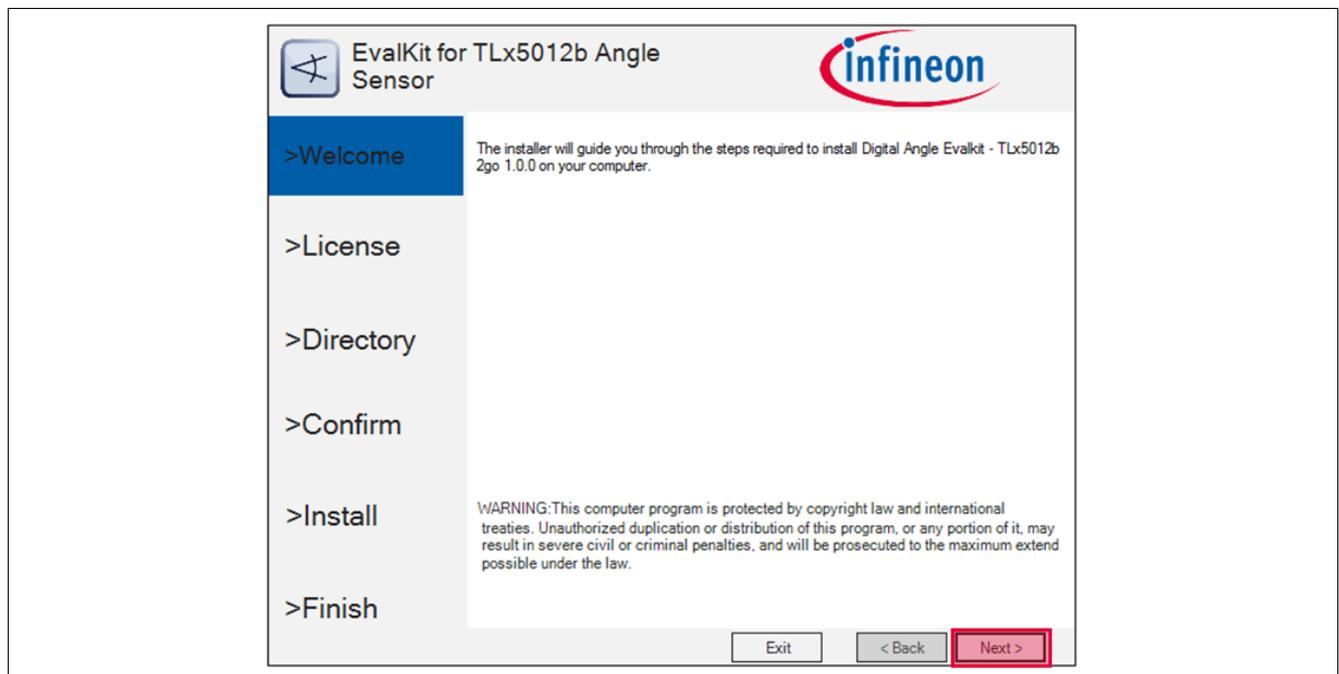

Figure 6 TLx5012B 2go software installation - step 1

Software installation

Software installation - step 2

Please read the license agreement and check the “I accept the terms in the License Agreement” checkbox. The **Next** button is only activated after agreeing with the terms.

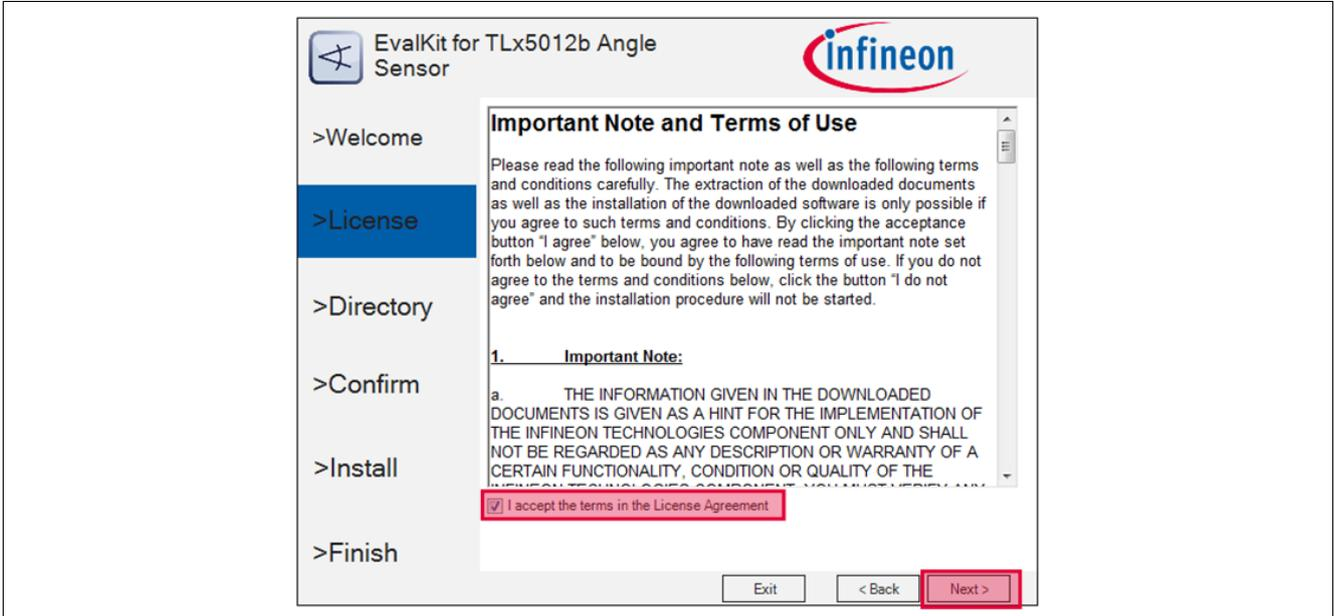

Figure 7 TLx5012B 2go software installation - step 2

Software installation - step 3

It is recommended is to use the default installation path, but you can select a different installation folder. You can also select whether a desktop icon is to be generated or not. The hardware device will only operate on a computer that has the Segger Jlink driver installed. The installer checks this, and if no driver is found, you can select to install Segger Jlink driver as well. The software GUI is built in .NET environment 4.5. A check is being done for compatibility and you can select to install (if not already installed) the .NET framework 4.7 (web installer – requires connection to internet).

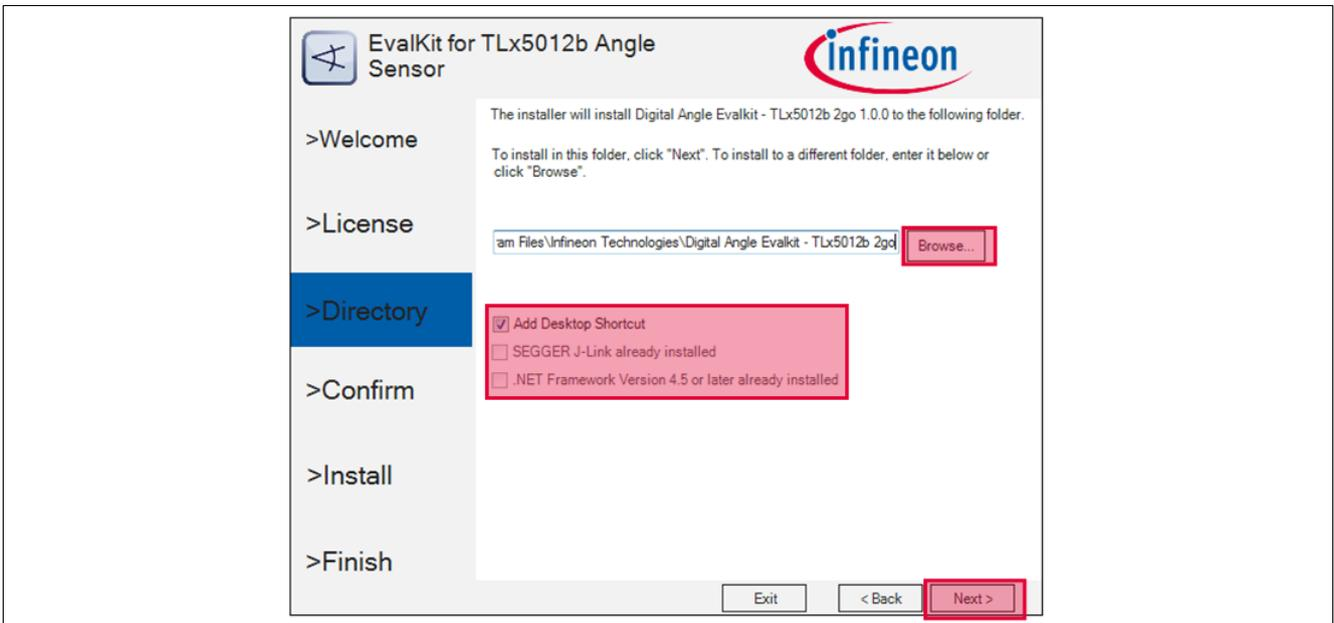

Figure 8 TLx5012B 2go software installation - step 3

Software installation

Software installation - step 4

Confirm the installation process.

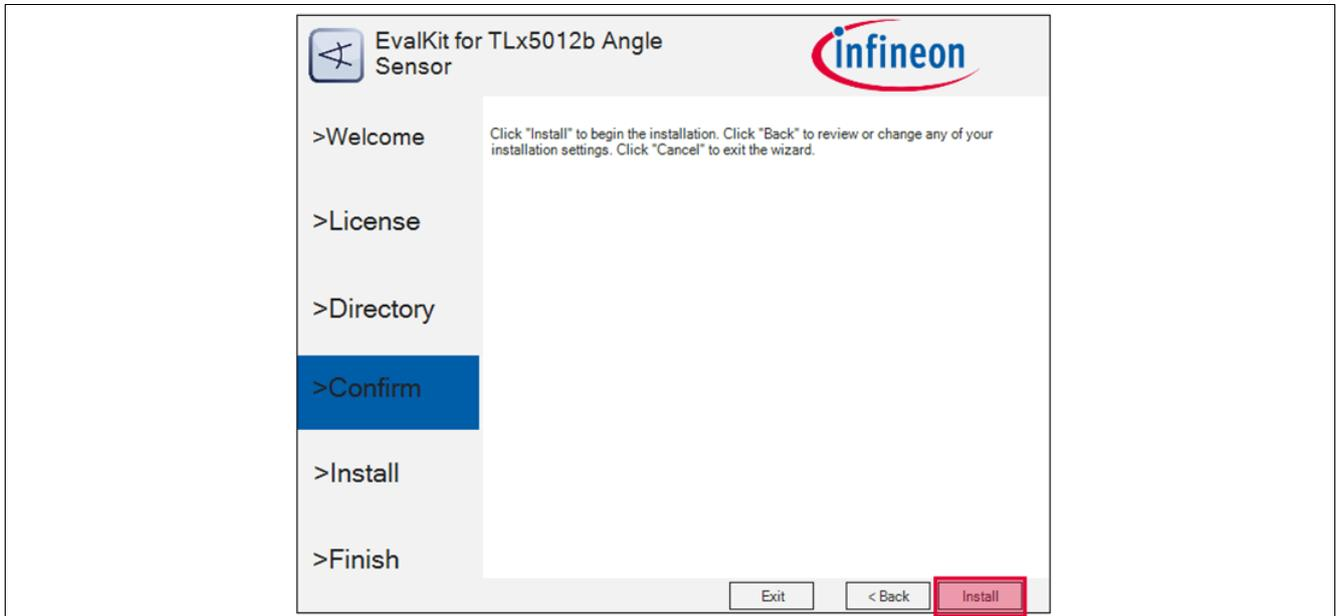

Figure 9 TLx5012B 2go software installation - step 4

Software installation - step 5

The installation process starts. The Windows UAC (user access control) will prompt for access confirmation. Depending on the security settings, you may need administration rights on the installation machine. Wait for the installation process to finish.

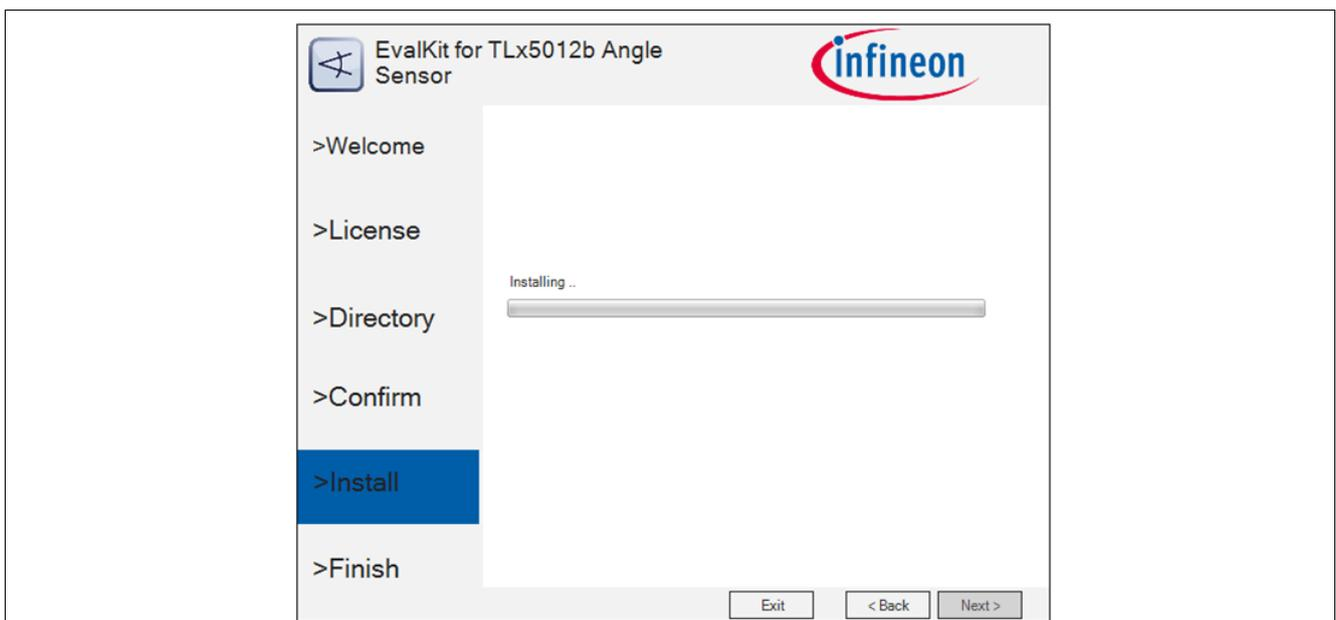

Figure 10 TLx5012B 2go software installation - step 5

Software installation

Software installation - step 6

Finalize the installation by clicking **Finish**.

Check the message provided by the installer. In case of errors, you will not be able to start the application.

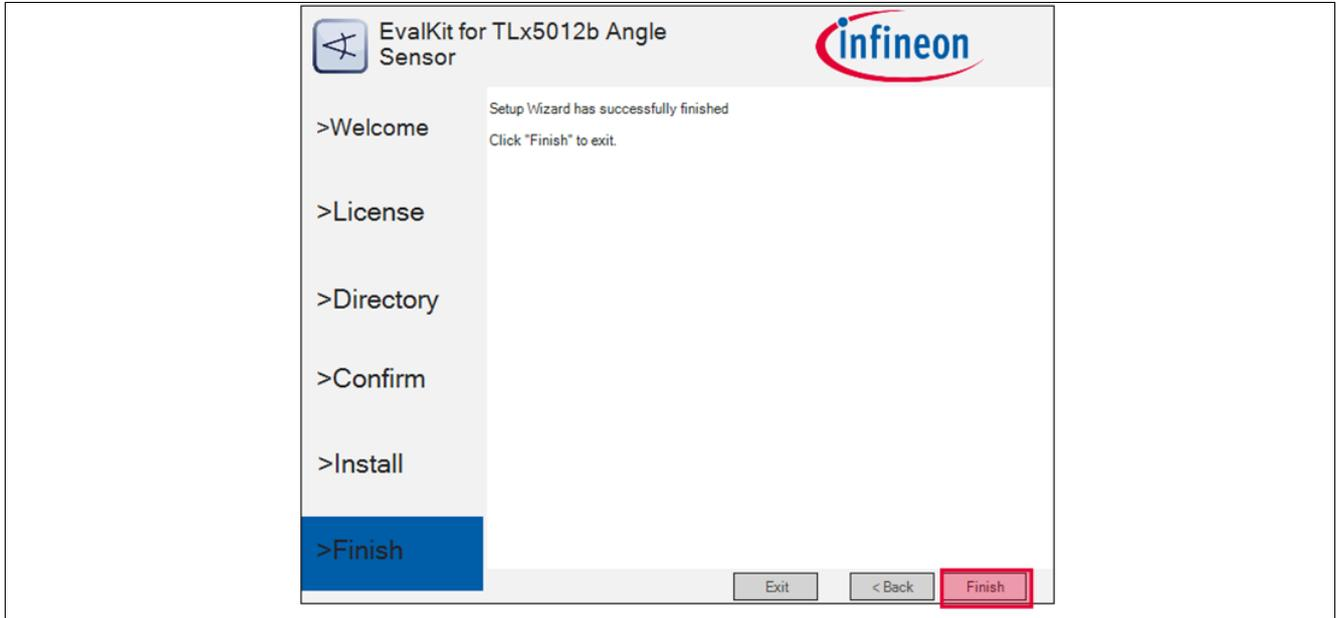

Figure 11 TLx5012B 2go software installation - step 6

3 Evaluation Kit for GMR based angle sensors

3.1 Connection to PC and starting the application

Connect the hardware to the PC using a USB to Micro-USB cable.

Start the application (via the shortcut on the desktop or **Start > All Programs > Infineon Technologies > Digital Angle EvalKit – TLx5012b 2go > TLx5012b 2go EvalKit**).

GUI components

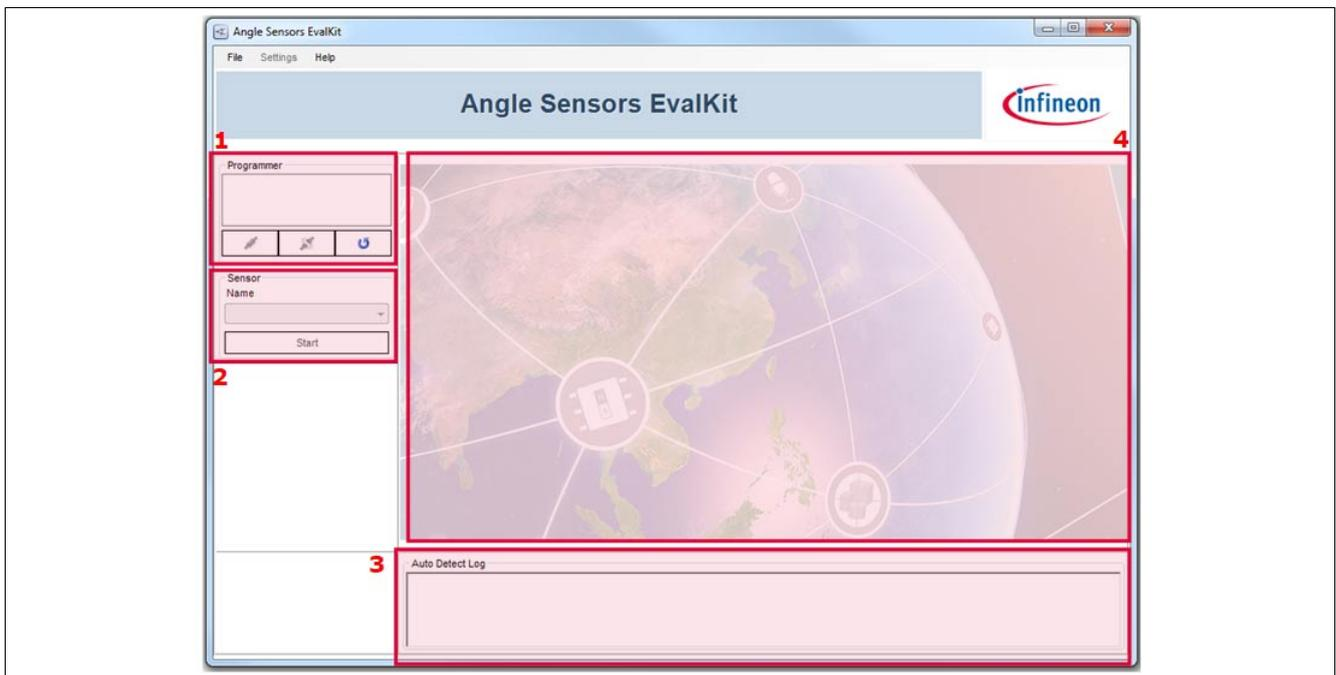

Figure 12 TLx5012B 2go application start

1. This GUI component will show any connected devices. You can select the device and open a connection / flash the device.
2. Select the sensor type via the combo box and start/stop the acquisition.
3. This GUI component provides a log showing the type of device connected (derivative) and the active protocol.
4. This is the sensor acquisition panel; it will be displayed after a valid sensor has been selected by the user.

Evaluation Kit for GMR based angle sensors

3.2 SPI display

For any device, if the SPI bus is active, you can choose the SPI interface as readout interface.

The sensor panel is automatically configured and you may see the following controls:

- Gauge: shows the angle value between -180 : 180 degrees
- Real time graph for plotting the angle value
- Acquisition Log: stores all angle data in LSB/Degrees, including safety word, CRC check and safety word decoding

Using the **Save** button (active only when the acquisition is stopped), you can export the acquired data in CSV format.

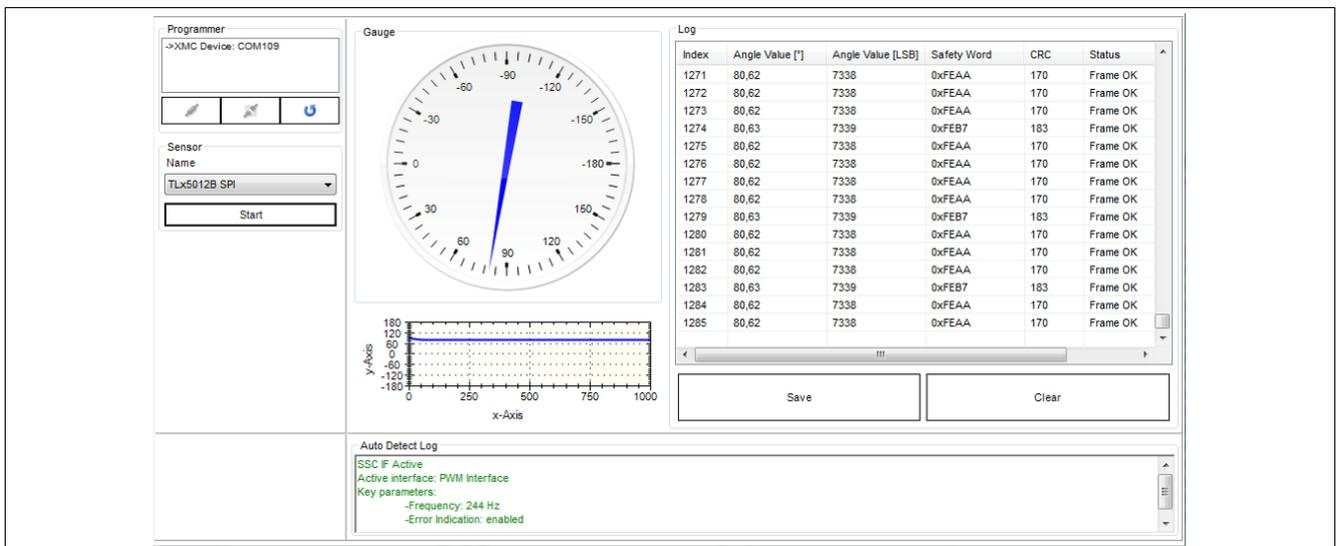

Figure 13 SPI display

Evaluation Kit for GMR based angle sensors

3.3 IIF display

For devices of type E1000 or for IIF soft fused devices the following sensor panel can be used by selecting the sensor type “TLx5012b Incremental”. The software can decode both A/B mode and Step/Direction mode. The number of steps per rotation can vary between 4096, 2048, 1024 and 512.

Active controls:

- Gauge: shows the angle value in degrees from -180 to 180
- Acquisition Log: shows the angle value in degrees and the number of steps incremented

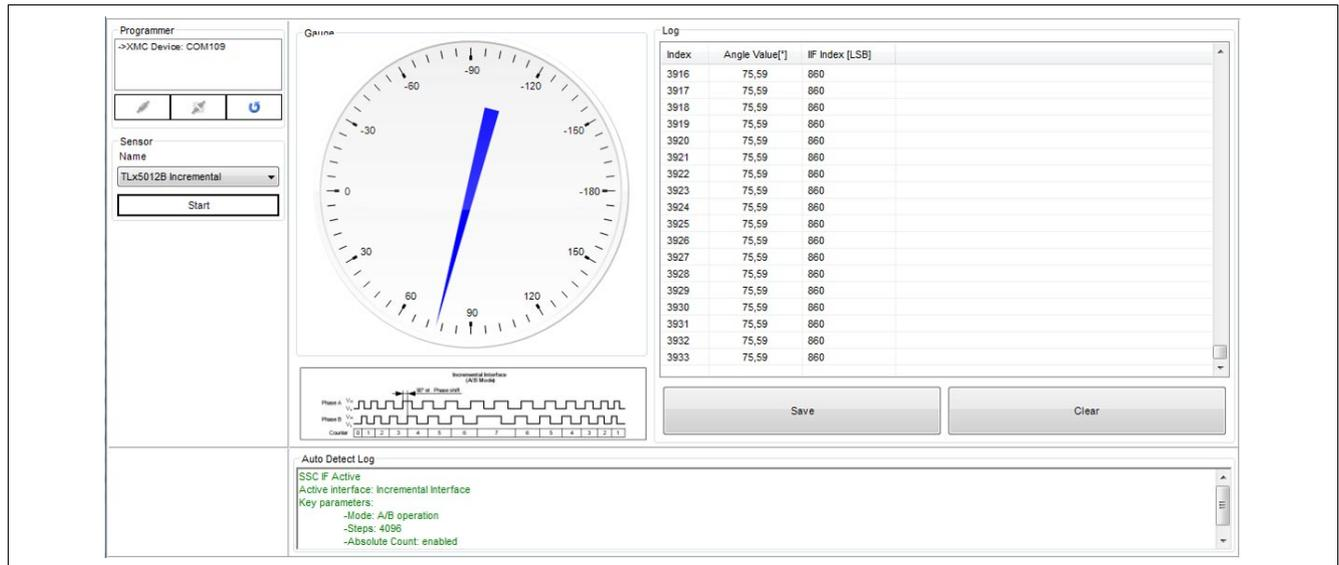

Figure 14 IIF display

Evaluation Kit for GMR based angle sensors

3.4 PWM display

For devices of type E5000 or E5020 or for PWM soft fused devices the following sensor panel can be used by selecting the sensor type “TLx5012b PWMI”. The software can decode all supported frequencies: 244 Hz, 488 Hz, 977 Hz and 1953 Hz. If the error indication feature is enabled, the sensor will also signal system errors at duty cycle 98% or 2%.

Active controls:

- Gauge: shows the angle value in degrees from -180 to 180
- Acquisition Log: shows the angle value in degrees and duty cycle, measured ON time, OFF time and Period (milliseconds) and status
- Graph: shows the real-time angle value between -180 to 180 degrees

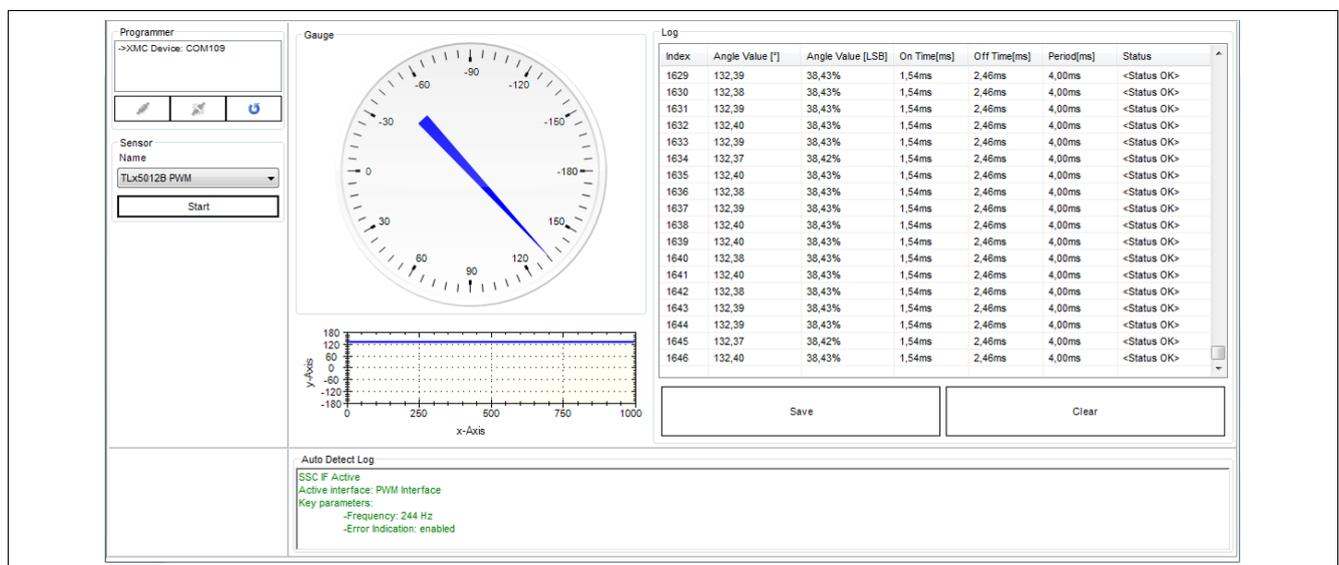

Figure 15 PWM display

Evaluation Kit for GMR based angle sensors

3.5 SPC display

For devices of type E9000 or for SPC soft fused devices the following sensor panel can be used by selecting the sensor type “TLx5012b SPC”. The software supports all unit types (3us, 2.5us, 2us and 1.5us) and all SPC frame formats (Angle 12bit, Angle 16bit, Angle 12bit + Temperature 8bit, Angle 16bit+Temperature 8bit).

Active controls:

- Gauge: shows the angle value in degrees from -180 to 180
- Acquisition Log: shows the angle value in degrees and in LSB, status nibble value, CRC nibble check, temperature in LSB and degrees Celcius (if part of the SPC frame)
- Graph: shows the real-time angle value between -180 to 180 degrees

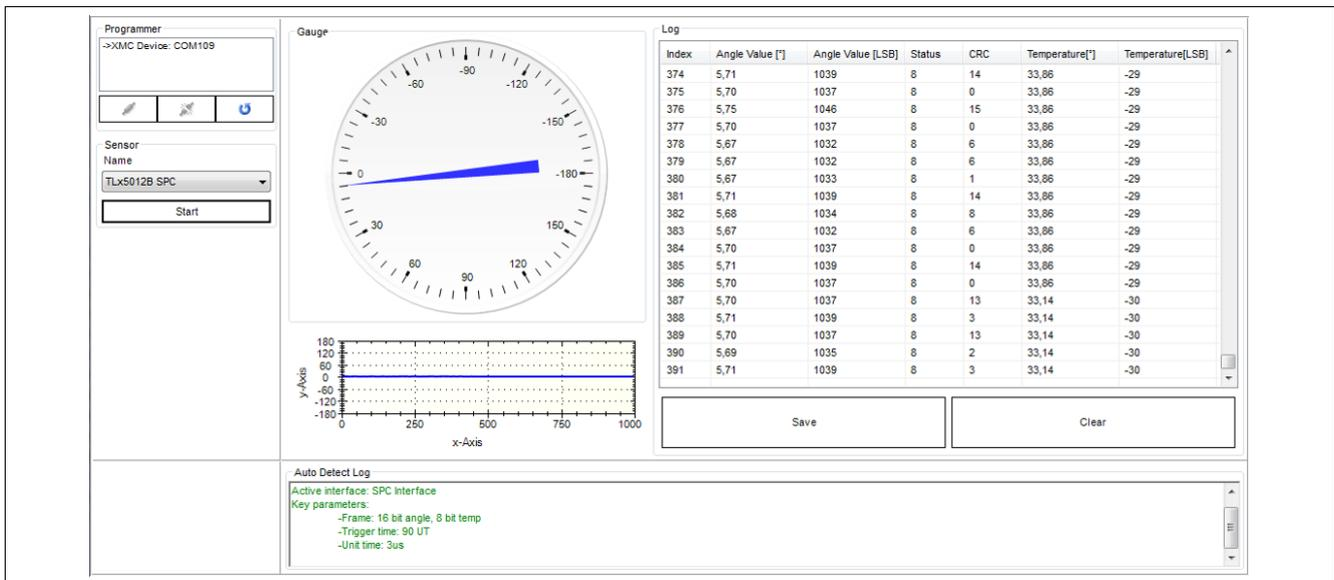

Figure 16 SPC display

Evaluation Kit for GMR based angle sensors

3.6 Save File feature

You can save the acquired data by clicking the **Save** button in the sensor panel. In the pop-up Save menu, enter the path and the file name as .CSV and save your data. The .CSV file can be opened in Microsoft Excel for post processing of the data.

	A	B	C	D	E	F	G	H
1	Date:14 septembrie 2018							
2	TLx5012B							
3	Index	Angle[degrees]	Angle[LSB]	Temperature[C]	Temperature[LSB]	Status	CRC	
4	0	6	1093	33,14	-30	8	2	
5	1	5,99	1091	33,86	-29	8	0	
6	2	6,02	1095	33,86	-29	8	1	
7	3	6	1093	33,86	-29	8	15	
8	4	6	1093	33,86	-29	8	15	
9	5	6,02	1095	33,86	-29	8	1	
10	6	6,02	1095	33,86	-29	8	1	
11	7	6	1093	33,86	-29	8	15	
12	8	6	1093	33,86	-29	8	15	
13	9	6	1093	33,86	-29	8	15	
14	10	5,99	1091	33,86	-29	8	0	
15	11	5,99	1091	33,86	-29	8	0	
16	12	6	1093	33,86	-29	8	15	
17	13	5,99	1091	33,86	-29	8	0	

Figure 17 Save File feature

Evaluation Kit for GMR based angle sensors

3.7 RAM memory access

The evaluation kit software allows reading / writing the internal RAM memory.

To access the memory go to **Settings -> RAM Memory**. The window shown below will pop-up:

- Addresses 0 – 17 are being displayed. You can select individual lines / bit fields for reading or for writing. For example, in the screenshot below the angle base field is selected. By modifying the value (hexadecimal / decimal) the memory map will get updated. Press the **Set in RAM** button to confirm the RAM write.
- **Read RAM** will refresh the displayed memory map.
- **Load / Save Configuration** allows loading / saving a RAM content in XML format.
- The **Read ONLY** section cannot be modified (is software protected).

Attention: Please note that the sensor may end up in an undefined state if the protocol settings are changed while the sensor is running!

If this window is closed, the sensor selection in the main window is invalidated so the user has to re-select the sensor type.

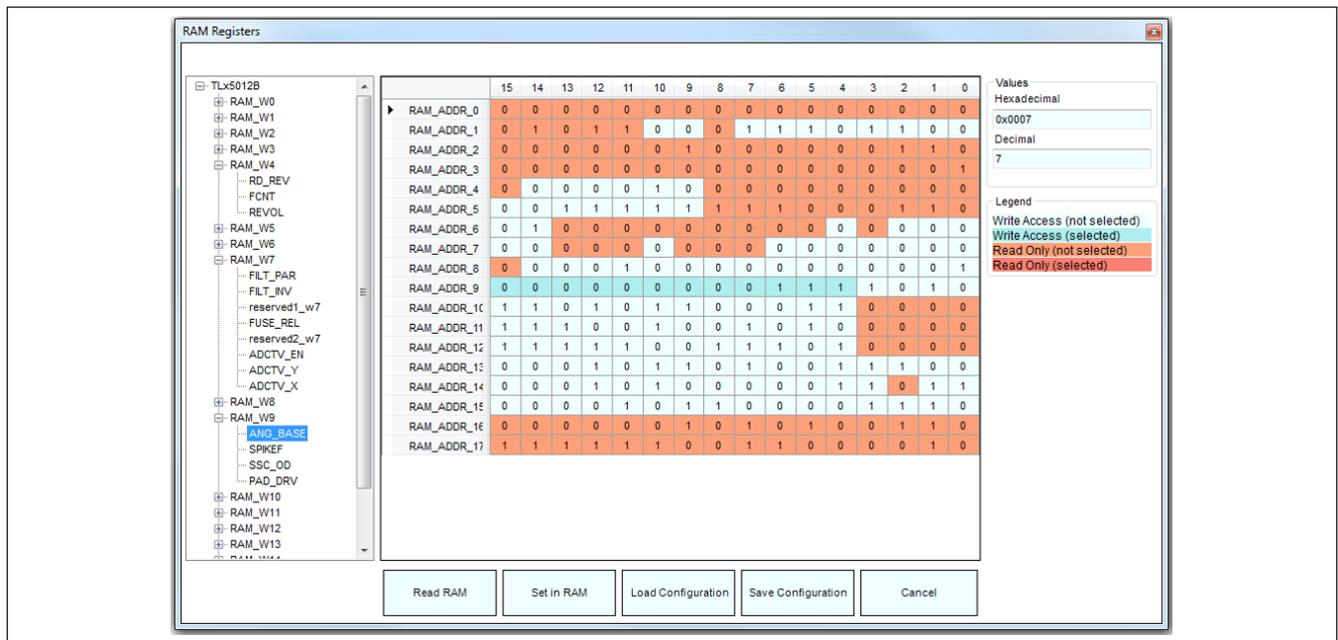

Figure 18 RAM memory access

Evaluation Kit for GMR based angle sensors

3.8 Soft fusing of protocols

To enable soft fusing go to **Settings > Protocol Soft Fusing**.

You may fuse three different protocols: IIF, PWM and SPC.

After closing this window, the sensor type is invalidated and the user has to re-select the sensor type as the protocol can be different.

IIF provides the following fusing options:

- Mode: You can choose between A/B mode and Step/Direction mode. Refer to the sensor user manual for details.
- Number of steps per rotation: 4096, 2048, 1024 or 512
- Absolute count: enabled or disabled

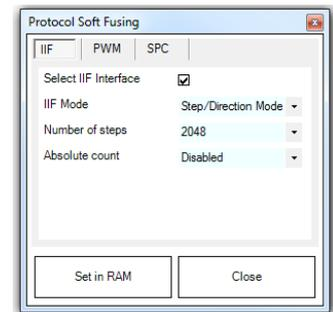

PWM provides the following fusing options:

- Frequency: 244 Hz, 488 Hz, 977 Hz and 1953 Hz
- Error indication: enabled or disabled

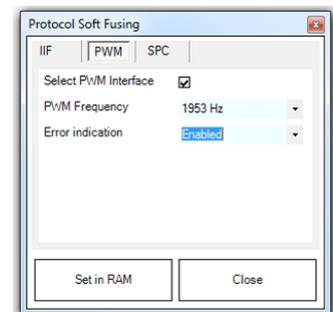

SPC provides the following fusing options:

- Unit time: 3us, 2.5us, 2us and 1.5us
- Frame configuration:
 - 12bit angle
 - 16bit angle
 - 12bit angle + 8bit temperature
 - 16bit angle + 8bit temperature
- Trigger time: 90 unit times or 12 unit times + $t_{\text{m\textit{low}}}$

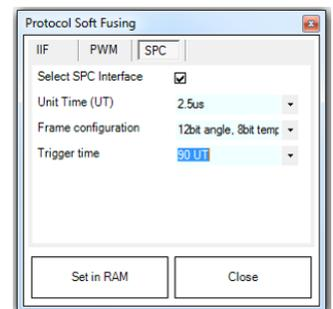

Evaluation Kit for GMR based angle sensors

3.9 Software & Firmware revision

If you access the menu **Help > About**, the following versioning information will be displayed:



Figure 19 Software & Firmware revision

3.10 User manual

The user manual can be opened directly from the GUI by accessing the menu **Help > Manual**.

Revision history

4 Revision history

Revision	Date	Changes
Rev. 1.0	2018-09-27	Initial creation.

Trademarks

All referenced product or service names and trademarks are the property of their respective owners.

Edition 2018-09-27

Published by

Infineon Technologies AG

81726 Munich, Germany

© 2018 Infineon Technologies AG.

All Rights Reserved.

Do you have a question about any aspect of this document?

Email: erratum@infineon.com

Document reference

IMPORTANT NOTICE

The information given in this document shall in no event be regarded as a guarantee of conditions or characteristics ("Beschaffenhheitsgarantie").

With respect to any examples, hints or any typical values stated herein and/or any information regarding the application of the product, Infineon Technologies hereby disclaims any and all warranties and liabilities of any kind, including without limitation warranties of non-infringement of intellectual property rights of any third party.

In addition, any information given in this document is subject to customer's compliance with its obligations stated in this document and any applicable legal requirements, norms and standards concerning customer's products and any use of the product of Infineon Technologies in customer's applications.

The data contained in this document is exclusively intended for technically trained staff. It is the responsibility of customer's technical departments to evaluate the suitability of the product for the intended application and the completeness of the product information given in this document with respect to such application.

For further information on technology, delivery terms and conditions and prices, please contact the nearest Infineon Technologies Office (www.infineon.com).

WARNINGS

Due to technical requirements products may contain dangerous substances. For information on the types in question please contact your nearest Infineon Technologies office.

Except as otherwise explicitly approved by Infineon Technologies in a written document signed by authorized representatives of Infineon Technologies, Infineon Technologies' products may not be used in any applications where a failure of the product or any consequences of the use thereof can reasonably be expected to result in personal injury.

单击下面可查看定价，库存，交付和生命周期等信息

[>>Infineon\(英飞凌\)](#)