

Hybrid CoolSiC™ IGBT

TRENCHSTOP™ 5 S5 IGBT co-packed with full-rated 6th generation CoolSiC™ Schottky barrier diode**Features and Benefits:**

- Ultra-low switching losses due to the combination of TRENCHSTOP™ 5 and CoolSiC™ technology
- Very low on-state losses
- Benchmark efficiency in hard switching topologies
- Plug-and-play replacement of pure silicon devices
- Maximum junction temperature 175°C
- Qualified according to JEDEC for target applications
- Pb-free lead plating; RoHS compliant
- Complete product spectrum and PSpice models: <http://www.infineon.com/igbt/>

**Potential Applications:**

- Industrial Power Supplies
 - Industrial SMPS
 - Industrial UPS
- Energy Generation
 - Solar String Inverter
- Energy Distribution
 - Energy Storage
- Infrastructure – Charge
 - Charger

**Product Validation:**

Qualified for applications listed above based on the test conditions in the relevant tests of JEDEC20/22

Package pin definition:

- Pin 1 - gate
- Pin 2 & backside - collector
- Pin 3 - emitter

**Key Performance and Package Parameters**

Type	V_{CE}	I_C	$V_{CEsat}, T_{vj}=25^{\circ}C$	T_{vjmax}	Marking	Package
IKW50N65SS5	650V	50A	1.35V	175°C	K50ESS5	PG-TO247-3

Table of Contents

Description	1
Table of Contents	2
Maximum Ratings	3
Thermal Resistance	3
Electrical Characteristics	4
Electrical Characteristics Diagrams	6
Package Drawing	12
Testing Conditions	13
Revision History	14
Disclaimer	15

Hybrid CoolSiC™ IGBT

Maximum Ratings

For optimum lifetime and reliability, Infineon recommends operating conditions that do not exceed 80% of the maximum ratings stated in this datasheet.

Parameter	Symbol	Value	Unit
Collector-emitter voltage, $T_{vj} \geq 25^{\circ}\text{C}$	V_{CE}	650	V
DC collector current, limited by T_{vjmax} $T_c = 25^{\circ}\text{C}$ value limited by bondwire $T_c = 100^{\circ}\text{C}$	I_C	80.0 60.5	A
Pulsed collector current, t_p limited by T_{vjmax}	I_{Cpuls}	200.0	A
Turn off safe operating area $V_{CE} \leq 650\text{V}$, $T_{vj} \leq 175^{\circ}\text{C}$, $t_p = 1\mu\text{s}$	-	200.0	A
Diode forward current, limited by T_{vjmax} $T_c = 25^{\circ}\text{C}$ $T_c = 100^{\circ}\text{C}$	I_F	57.5 38.5	A
Diode pulsed current, t_p limited by $T_{vjmax}^{1)}$	I_{Fpuls}	150.0	A
Gate-emitter voltage Transient Gate-emitter voltage ($t_p \leq 10\mu\text{s}$, $D < 0.010$)	V_{GE}	± 20 ± 30	V
Power dissipation $T_c = 25^{\circ}\text{C}$ Power dissipation $T_c = 100^{\circ}\text{C}$	P_{tot}	274.0 137.0	W
Operating junction temperature	T_{vj}	-40...+175	$^{\circ}\text{C}$
Storage temperature	T_{stg}	-55...+150	$^{\circ}\text{C}$
Soldering temperature, wave soldering 1.6mm (0.063in.) from case for 10s		260	$^{\circ}\text{C}$
Mounting torque, M3 screw Maximum of mounting processes: 3	M	0.6	Nm

Thermal Resistance

Parameter	Symbol	Conditions	Value			Unit
			min.	typ.	max.	
R_{th} Characteristics						
IGBT thermal resistance, junction - case	$R_{th(j-c)}$		-	-	0.55	K/W
Diode thermal resistance, junction - case	$R_{th(j-c)}$		-	-	1.00	K/W
Thermal resistance junction - ambient	$R_{th(j-a)}$		-	-	40	K/W

¹⁾ Pulse current level depends on T_{vj} of diode chip, see also Fig. "Maximum pulse current as a function of junction temperature"

Hybrid CoolSiC™ IGBT

Electrical Characteristic, at $T_{vj} = 25^{\circ}\text{C}$, unless otherwise specified

Parameter	Symbol	Conditions	Value			Unit
			min.	typ.	max.	
Static Characteristic						
Collector-emitter saturation voltage	V_{CEsat}	$V_{GE} = 15.0\text{V}$, $I_C = 50.0\text{A}$ $T_{vj} = 25^{\circ}\text{C}$ $T_{vj} = 125^{\circ}\text{C}$ $T_{vj} = 175^{\circ}\text{C}$	-	1.35	1.70	V
Diode forward voltage	V_F	$V_{GE} = 0\text{V}$, $I_F = 40.0\text{A}$ $T_{vj} = 25^{\circ}\text{C}$ $T_{vj} = 125^{\circ}\text{C}$ $T_{vj} = 175^{\circ}\text{C}$	-	1.35	1.50	V
Gate-emitter threshold voltage	$V_{GE(th)}$	$I_C = 0.50\text{mA}$, $V_{CE} = V_{GE}$	3.2	4.0	4.8	V
Zero gate voltage collector current	I_{CES}	$V_{CE} = 650\text{V}$, $V_{GE} = 0\text{V}$ $T_{vj} = 25^{\circ}\text{C}$ $T_{vj} = 175^{\circ}\text{C}$	-	-	1300	μA
Zero gate voltage collector current	I_{CES}	$V_{CE} = 480\text{V}$, $V_{GE} = 0\text{V}$ $T_{vj} = 25^{\circ}\text{C}$	-	-	40	μA
Gate-emitter leakage current	I_{GES}	$V_{CE} = 0\text{V}$, $V_{GE} = 20\text{V}$	-	-	100	nA
Transconductance	g_{fs}	$V_{CE} = 20\text{V}$, $I_C = 50.0\text{A}$	-	62.0	-	S

Electrical Characteristic, at $T_{vj} = 25^{\circ}\text{C}$, unless otherwise specified

Parameter	Symbol	Conditions	Value			Unit
			min.	typ.	max.	
Dynamic Characteristic						
Input capacitance	C_{ies}	$V_{CE} = 25\text{V}$, $V_{GE} = 0\text{V}$ $f = 250\text{kHz}$	-	2660	-	pF
Output capacitance	C_{oes}		-	530	-	
Reverse transfer capacitance	C_{res}		-	10	-	
Gate charge	Q_G	$V_{CC} = 520\text{V}$, $I_C = 50.0\text{A}$, $V_{GE} = 15\text{V}$	-	110.0	-	nC
Internal emitter inductance measured 5mm (0.197 in.) from case	L_E		-	13.0	-	nH

Switching Characteristic, Inductive Load

Parameter	Symbol	Conditions	Value			Unit
			min.	typ.	max.	

IGBT Characteristic, at $T_{vj} = 25^{\circ}\text{C}$

Turn-on delay time	$t_{d(on)}$	$T_{vj} = 25^{\circ}\text{C}$,	-	20	-	ns
Rise time	t_r	$V_{CC} = 400\text{V}$, $I_C = 50.0\text{A}$, $V_{GE} = 0.0/15.0\text{V}$,	-	10	-	ns
Turn-off delay time	$t_{d(off)}$	$R_{G(on)} = 9.0\Omega$, $R_{G(off)} = 9.0\Omega$,	-	140	-	ns
Fall time	t_f	$L\sigma = 30\text{nH}$, $C\sigma = 30\text{pF}$ $L\sigma$, $C\sigma$ from Fig. E	-	20	-	ns
Turn-on energy	E_{on}	Energy losses include "tail" and diode reverse recovery.	-	0.32	-	mJ
Turn-off energy	E_{off}		-	0.55	-	mJ
Total switching energy	E_{ts}		-	0.87	-	mJ

Hybrid CoolSiC™ IGBT

Turn-on delay time	$t_{d(on)}$	$T_{vj} = 25^{\circ}\text{C}$, $V_{CC} = 400\text{V}$, $I_C = 25.0\text{A}$, $V_{GE} = 0.0/15.0\text{V}$, $R_{G(on)} = 9.0\Omega$, $R_{G(off)} = 9.0\Omega$, $L\sigma = 30\text{nH}$, $C\sigma = 30\text{pF}$ $L\sigma$, $C\sigma$ from Fig. E Energy losses include "tail" and diode reverse recovery.	-	19	-	ns
Rise time	t_r		-	5	-	ns
Turn-off delay time	$t_{d(off)}$		-	155	-	ns
Fall time	t_f		-	25	-	ns
Turn-on energy	E_{on}		-	0.14	-	mJ
Turn-off energy	E_{off}		-	0.30	-	mJ
Total switching energy	E_{ts}		-	0.44	-	mJ

Switching Characteristic, Inductive Load

Parameter	Symbol	Conditions	Value			Unit
			min.	typ.	max.	

IGBT Characteristic, at $T_{vj} = 150^{\circ}\text{C}$

Turn-on delay time	$t_{d(on)}$	$T_{vj} = 150^{\circ}\text{C}$, $V_{CC} = 400\text{V}$, $I_C = 50.0\text{A}$, $V_{GE} = 0.0/15.0\text{V}$, $R_{G(on)} = 9.0\Omega$, $R_{G(off)} = 9.0\Omega$, $L\sigma = 30\text{nH}$, $C\sigma = 30\text{pF}$ $L\sigma$, $C\sigma$ from Fig. E Energy losses include "tail" and diode reverse recovery.	-	20	-	ns
Rise time	t_r		-	11	-	ns
Turn-off delay time	$t_{d(off)}$		-	163	-	ns
Fall time	t_f		-	20	-	ns
Turn-on energy	E_{on}		-	0.39	-	mJ
Turn-off energy	E_{off}		-	0.90	-	mJ
Total switching energy	E_{ts}		-	1.29	-	mJ

Turn-on delay time	$t_{d(on)}$	$T_{vj} = 150^{\circ}\text{C}$, $V_{CC} = 400\text{V}$, $I_C = 25.0\text{A}$, $V_{GE} = 0.0/15.0\text{V}$, $R_{G(on)} = 9.0\Omega$, $R_{G(off)} = 9.0\Omega$, $L\sigma = 30\text{nH}$, $C\sigma = 30\text{pF}$ $L\sigma$, $C\sigma$ from Fig. E Energy losses include "tail" and diode reverse recovery.	-	18	-	ns
Rise time	t_r		-	6	-	ns
Turn-off delay time	$t_{d(off)}$		-	191	-	ns
Fall time	t_f		-	25	-	ns
Turn-on energy	E_{on}		-	0.17	-	mJ
Turn-off energy	E_{off}		-	0.50	-	mJ
Total switching energy	E_{ts}		-	0.67	-	mJ

Hybrid CoolSiC™ IGBT

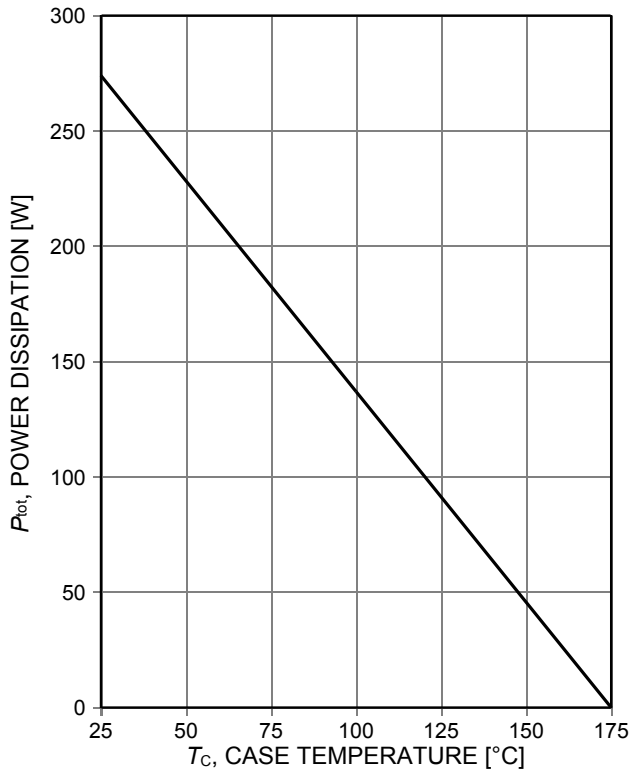

Figure 1. Power dissipation as a function of case temperature ($T_{vj} \leq 175^\circ\text{C}$)

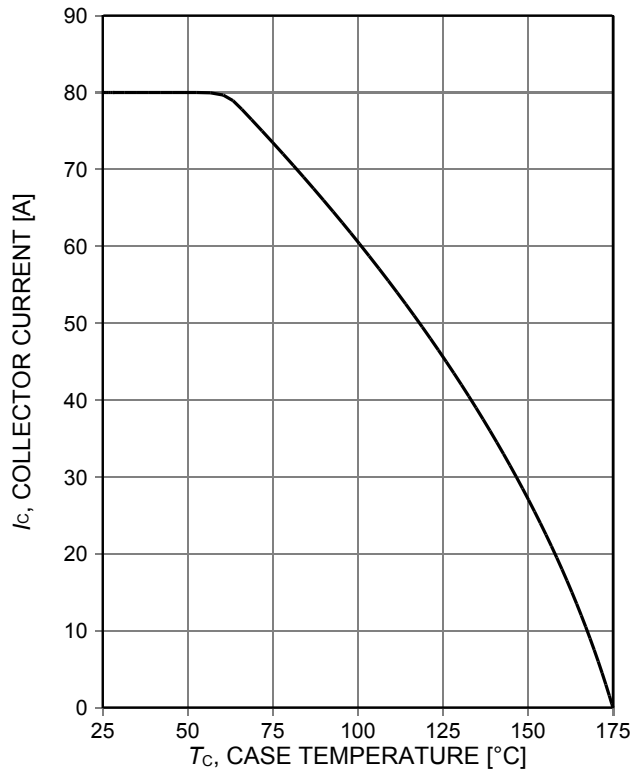

Figure 2. Collector current as a function of case temperature ($V_{GE} \geq 15\text{V}$, $T_{vj} \leq 175^\circ\text{C}$)

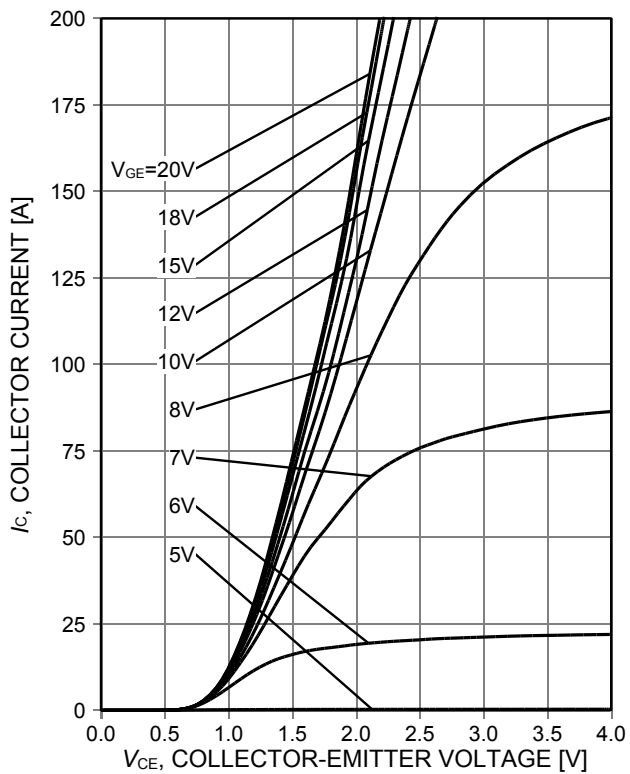

Figure 3. Typical output characteristic ($T_{vj} = 25^\circ\text{C}$)

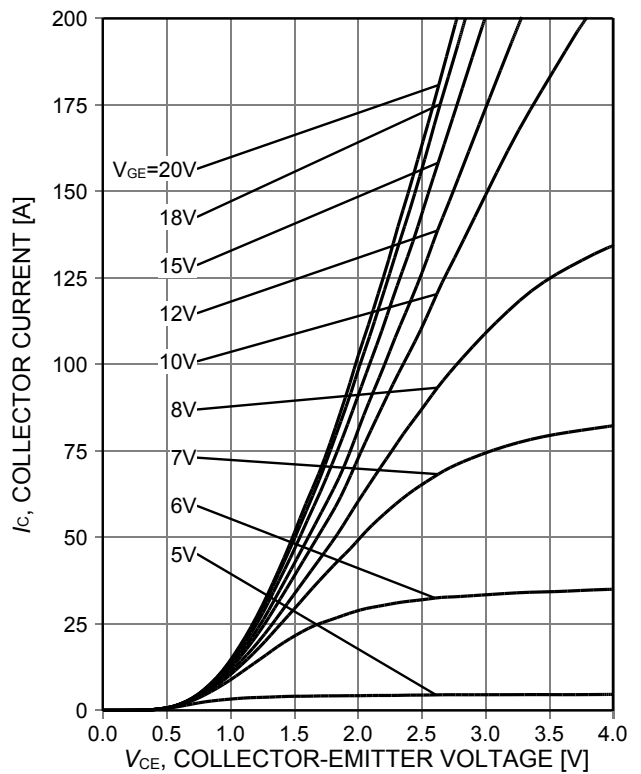

Figure 4. Typical output characteristic ($T_{vj} = 150^\circ\text{C}$)

Hybrid CoolSiC™ IGBT

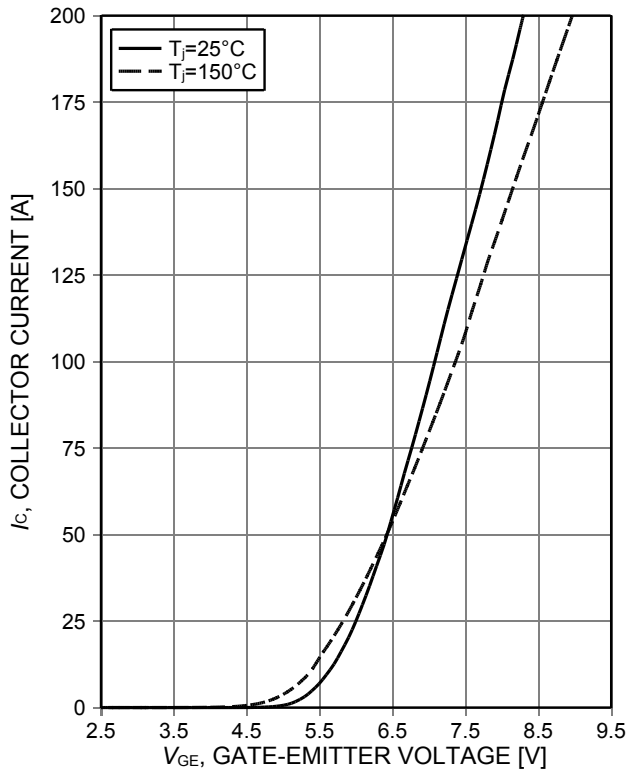

Figure 5. Typical transfer characteristic ($V_{CE}=20V$)

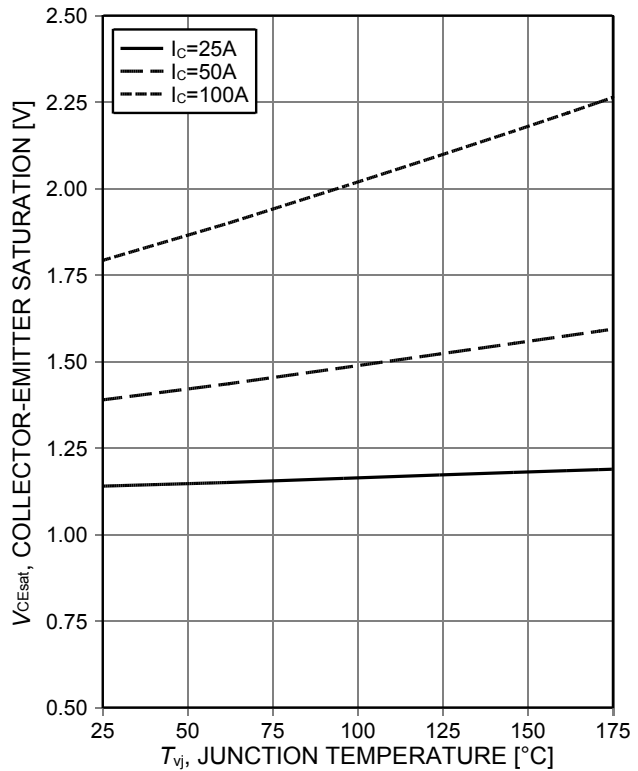

Figure 6. Typical collector-emitter saturation voltage as a function of junction temperature ($V_{GE}=15V$)

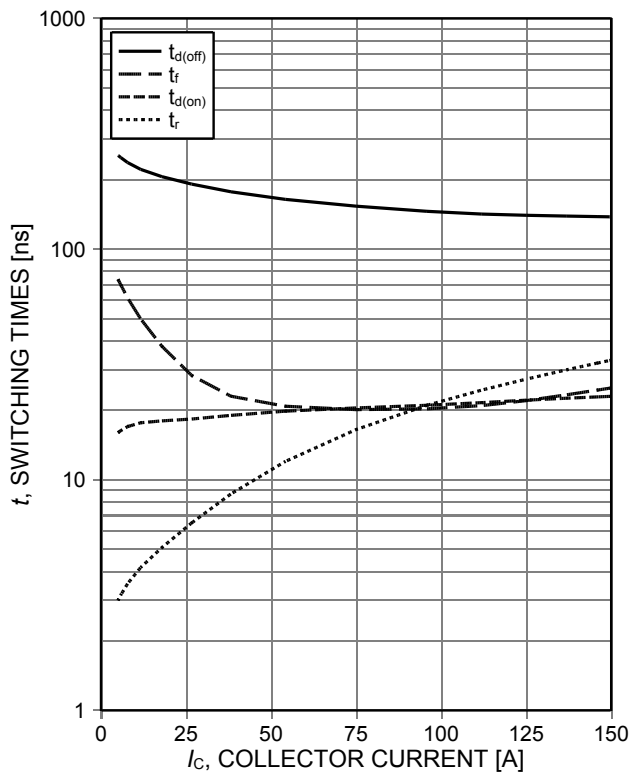

Figure 7. Typical switching times as a function of collector current (inductive load, $T_{vj}=150^{\circ}C$, $V_{CE}=400V$, $V_{GE}=15/0V$, $R_G=9\Omega$, Dynamic test circuit in Figure E)

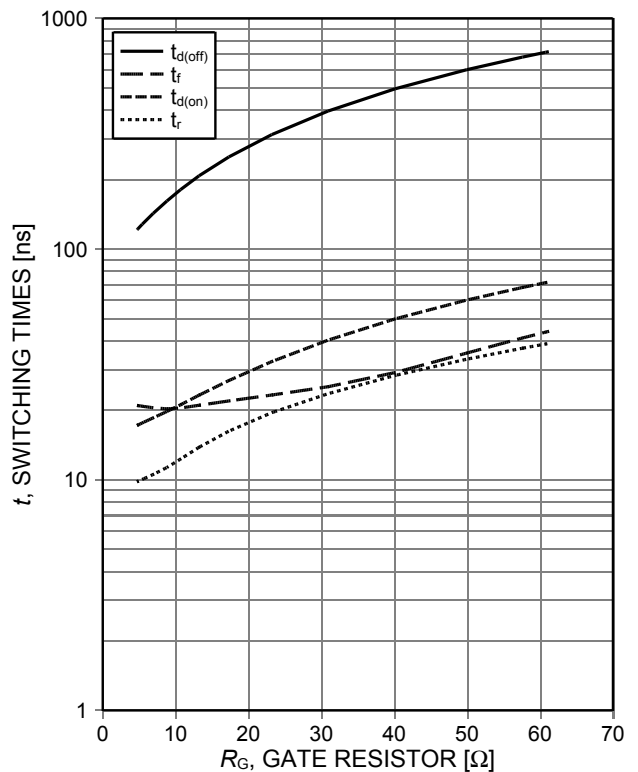

Figure 8. Typical switching times as a function of gate resistor (inductive load, $T_{vj}=150^{\circ}C$, $V_{CE}=400V$, $V_{GE}=15/0V$, $I_c=50A$, Dynamic test circuit in Figure E)

Hybrid CoolSiC™ IGBT

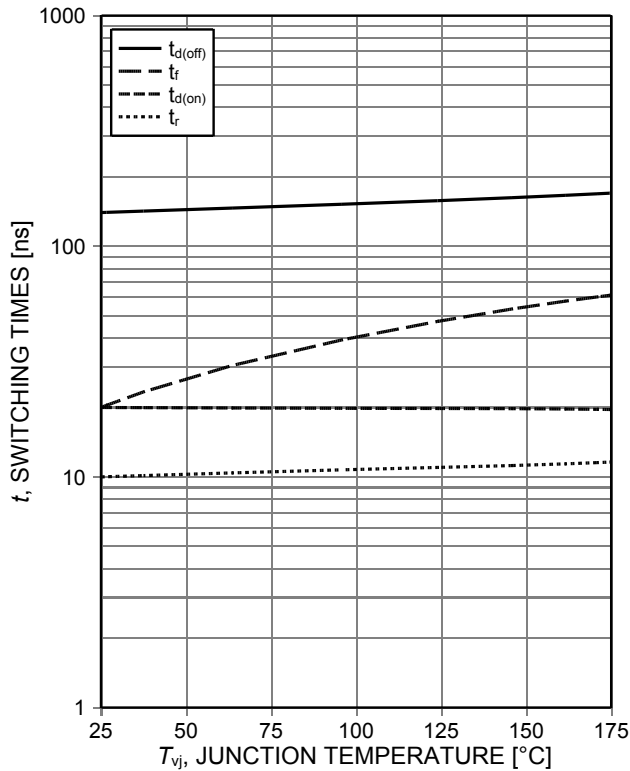

Figure 9. Typical switching times as a function of junction temperature (inductive load, $V_{CE}=400V$, $V_{GE}=15/0V$, $I_C=50A$, $R_G=9\Omega$, Dynamic test circuit in Figure E)

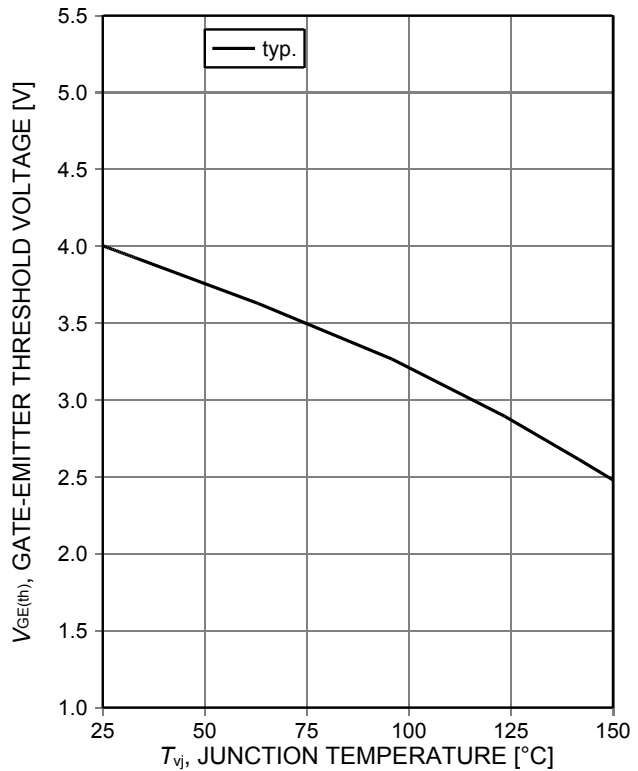

Figure 10. Gate-emitter threshold voltage as a function of junction temperature ($I_C=0.50mA$)

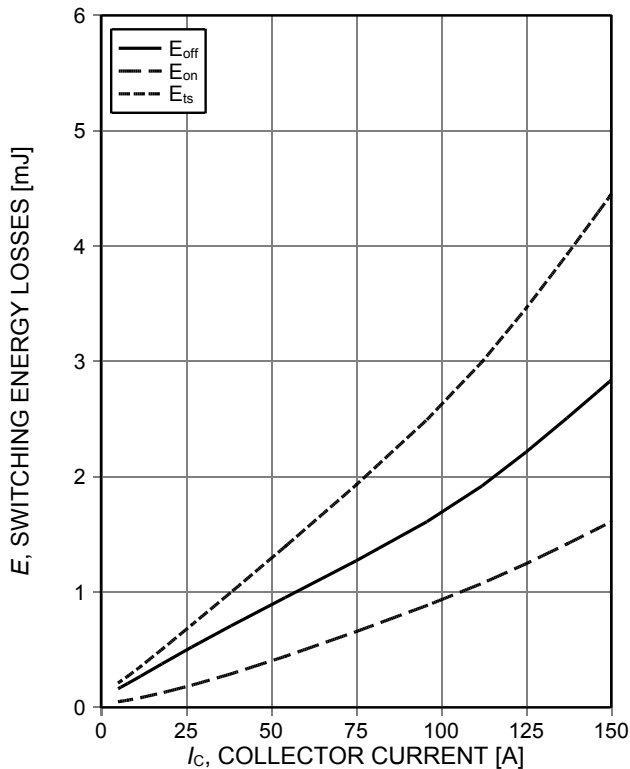

Figure 11. Typical switching energy losses as a function of collector current (inductive load, $T_{vj}=150^\circ C$, $V_{CE}=400V$, $V_{GE}=15/0V$, $R_G=9\Omega$, Dynamic test circuit in Figure E)

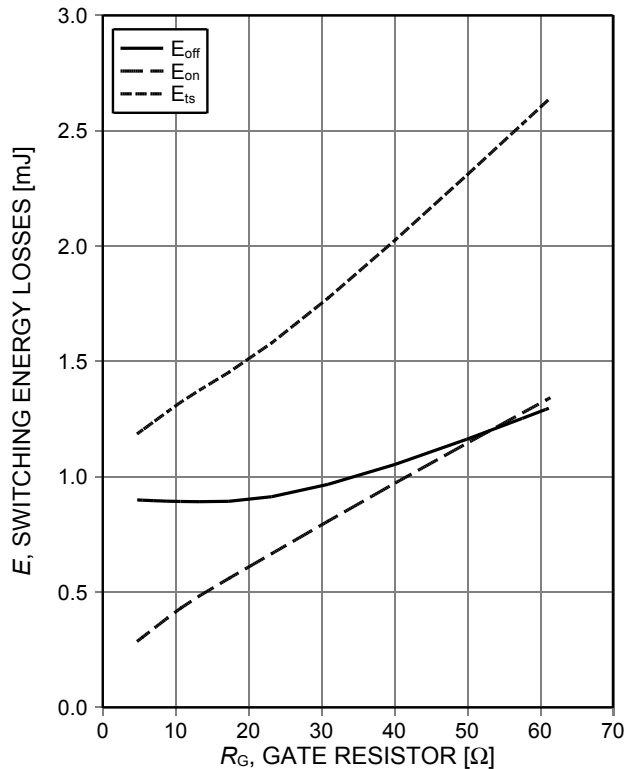

Figure 12. Typical switching energy losses as a function of gate resistor (inductive load, $T_{vj}=150^\circ C$, $V_{CE}=400V$, $V_{GE}=15/0V$, $I_C=50A$, Dynamic test circuit in Figure E)

Hybrid CoolSiC™ IGBT

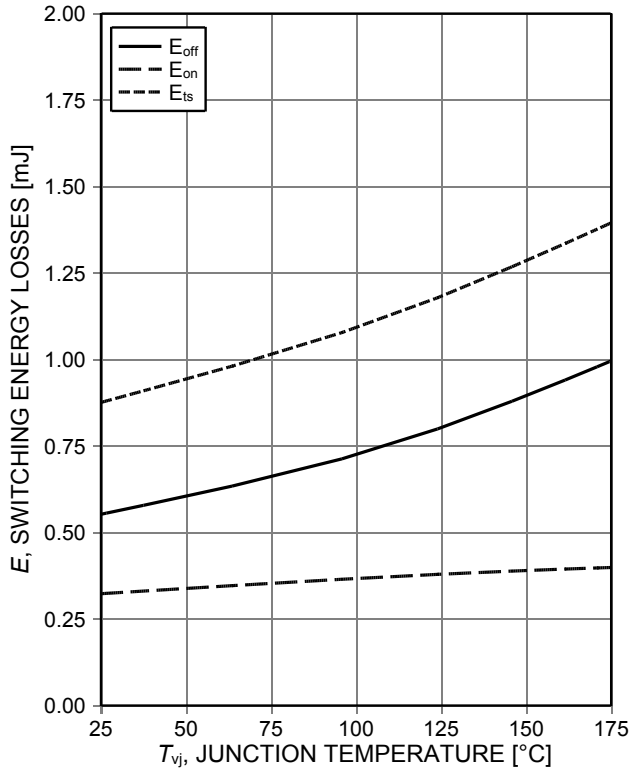

Figure 13. **Typical switching energy losses as a function of junction temperature** (inductive load, $V_{CE}=400V$, $V_{GE}=15/0V$, $I_C=50A$, $R_G=9\Omega$, Dynamic test circuit in Figure E)

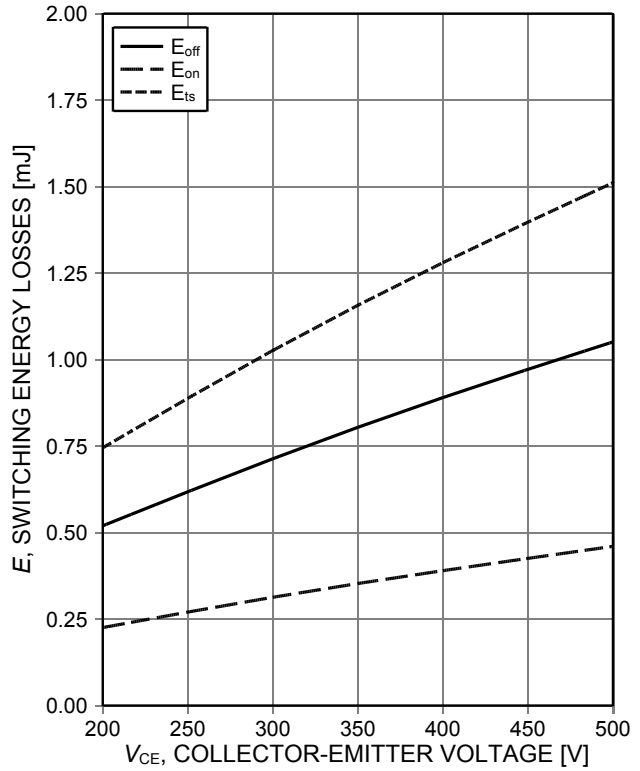

Figure 14. **Typical switching energy losses as a function of collector emitter voltage** (inductive load, $T_{vj}=150^\circ C$, $V_{GE}=15/0V$, $I_C=50A$, $R_G=9\Omega$, Dynamic test circuit in Figure E)

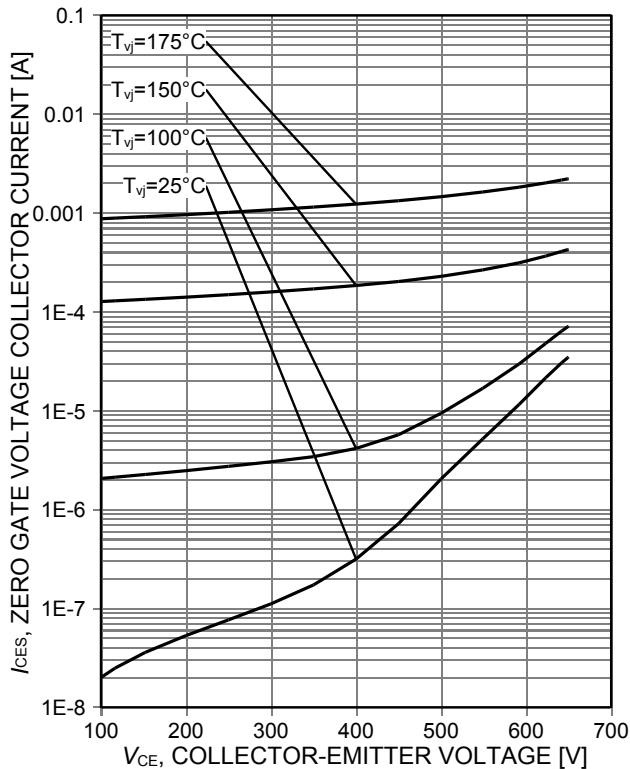

Figure 15. **Typ. reverse current vs. reverse voltage as a function of T_{vj}**

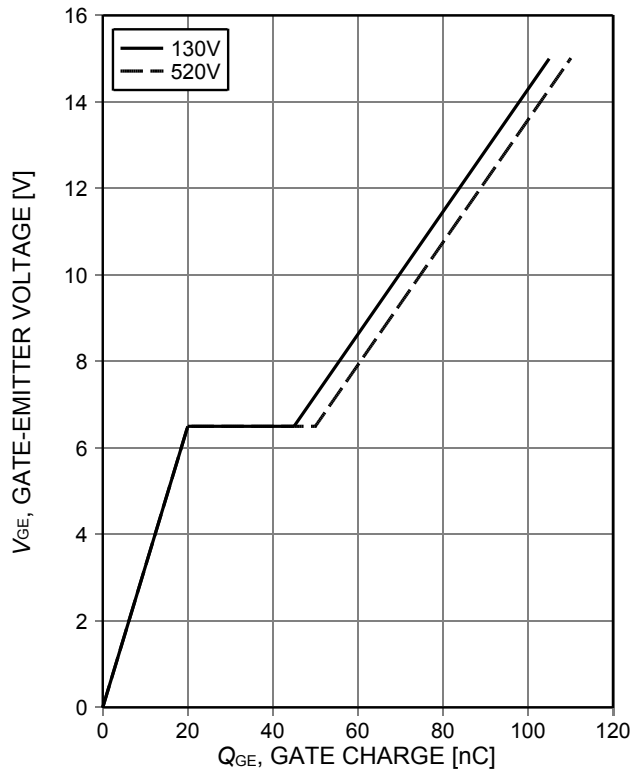

Figure 16. **Typical gate charge** ($I_C=50A$)

Hybrid CoolSiC™ IGBT

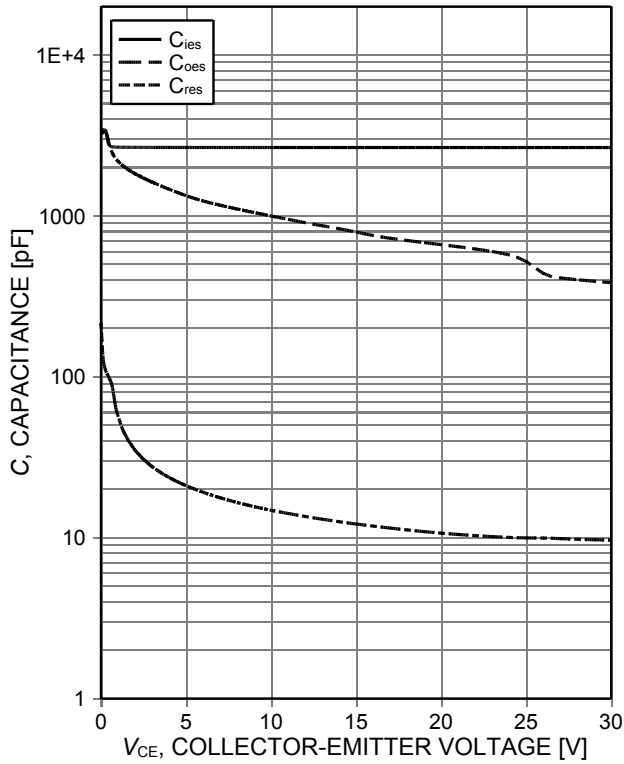

Figure 17. Typical capacitance as a function of collector-emitter voltage ($V_{GE}=0V, f=250kHz$)

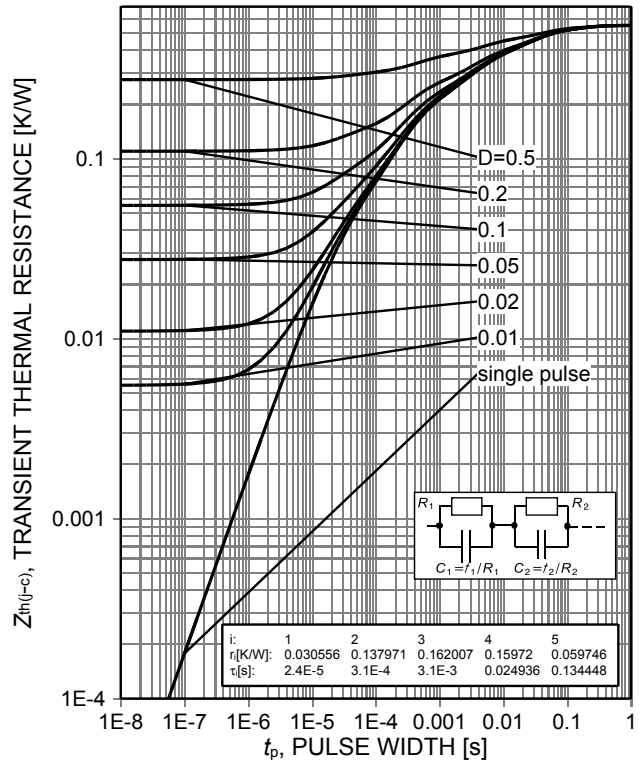

Figure 18. IGBT transient thermal resistance ($D=t_p/T$)

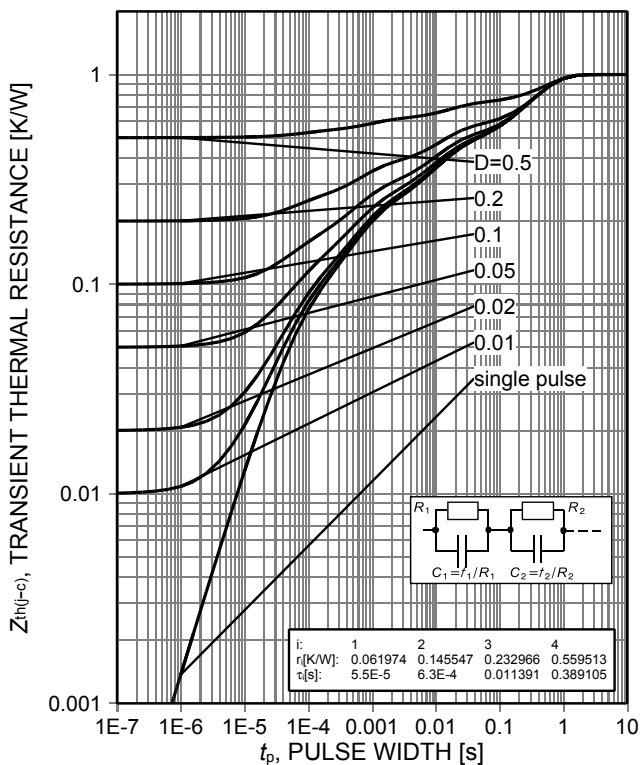

Figure 19. Diode transient thermal impedance as a function of pulse width ($D=t_p/T$)

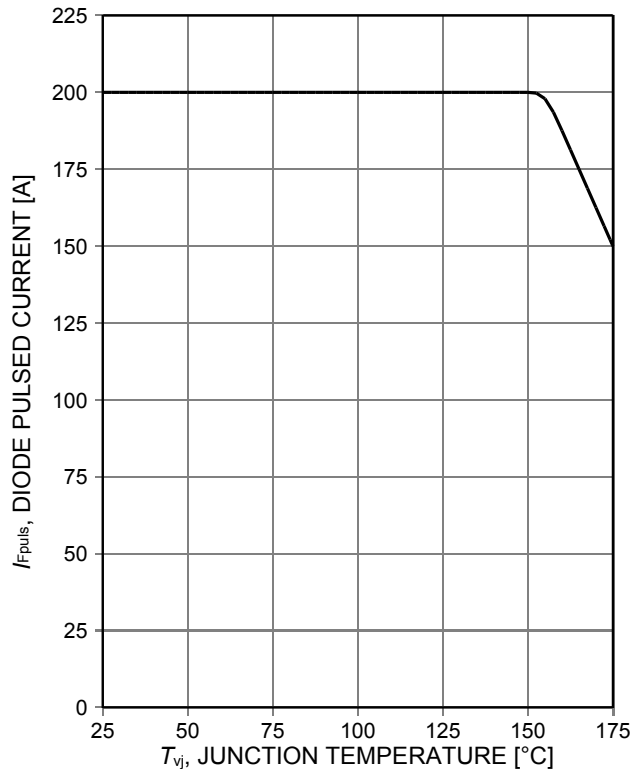

Figure 20. Maximum pulse current as a function of junction temperature

Hybrid CoolSiC™ IGBT

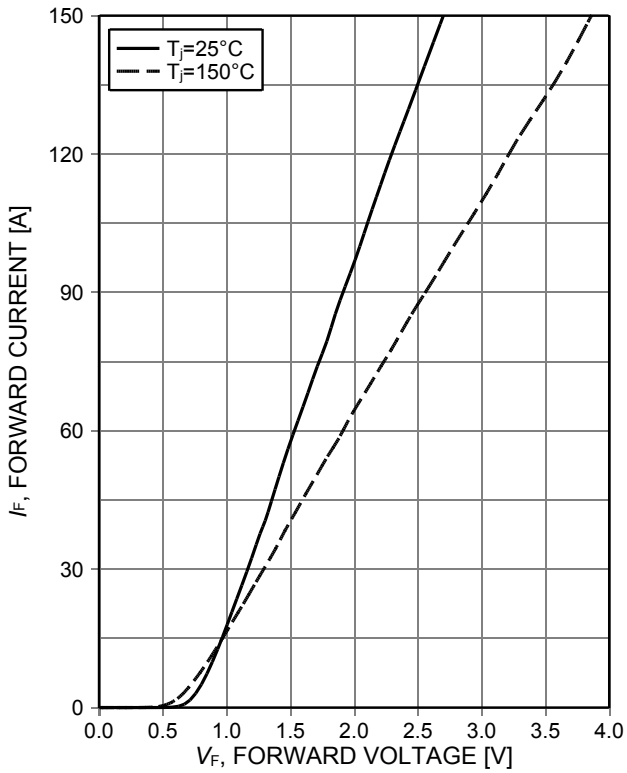

Figure 21. Typical diode forward current as a function of forward voltage

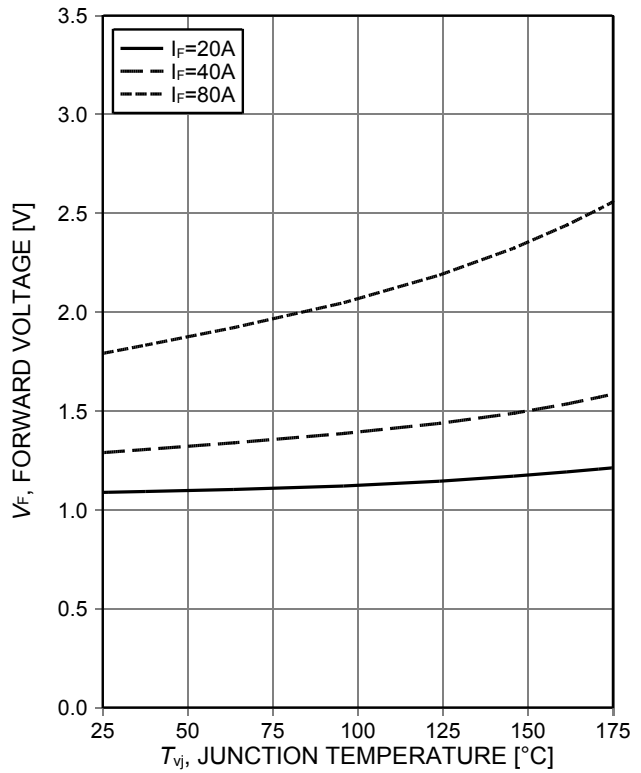
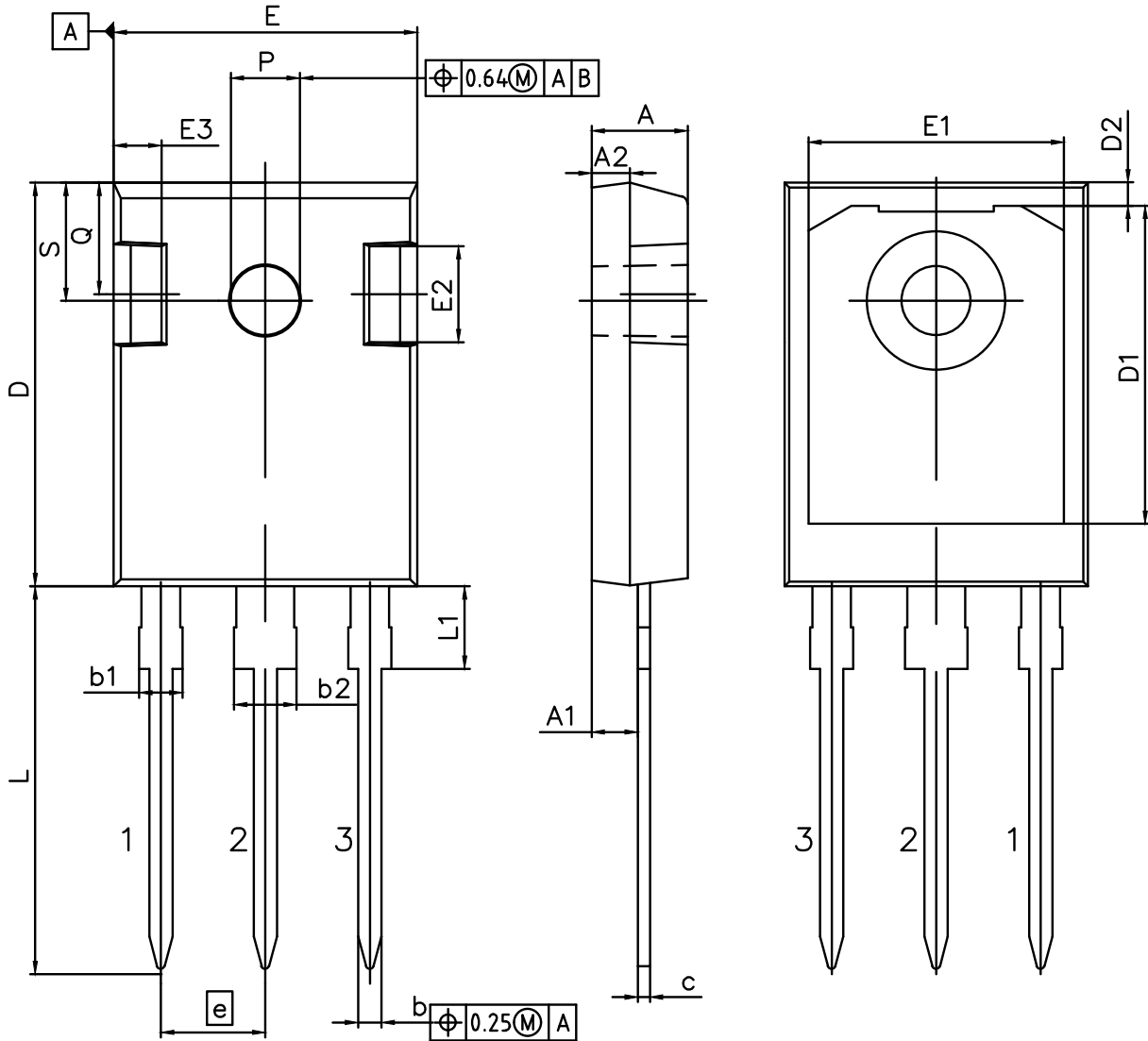

Figure 22. Typical diode forward voltage as a function of junction temperature

Package Drawing PG-TO247-3



DIMENSIONS	MILLIMETERS	
	MIN.	MAX.
A	4.70	5.30
A1	2.20	2.60
A2	1.50	2.50
b	1.00	1.40
b1	1.60	2.41
b2	2.57	3.43
c	0.38	0.89
D	20.70	21.50
D1	13.08	17.65
D2	0.51	1.35
E	15.50	16.30
E1	12.38	14.15
E2	3.40	5.10
E3	1.00	2.60
e	5.44	
L	19.80	20.40
L1	3.85	4.50
P	3.50	3.70
Q	5.35	6.25
S	6.04	6.30

DOCUMENT NO. Z8B00003327
REVISION 06
SCALE 3:1 0 1 2 3 4 5mm
EUROPEAN PROJECTION
ISSUE DATE 25.07.2018

Hybrid CoolSiC™ IGBT

Testing Conditions

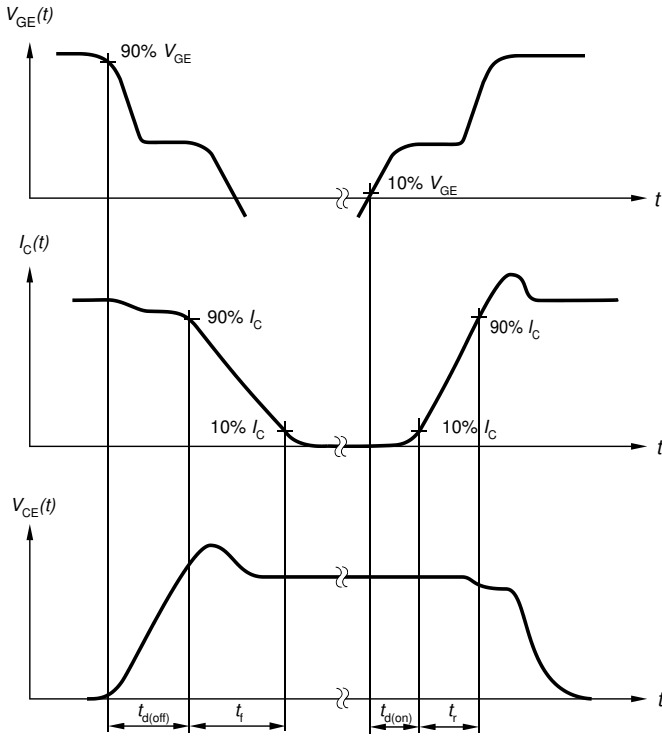

Figure A. Definition of switching times

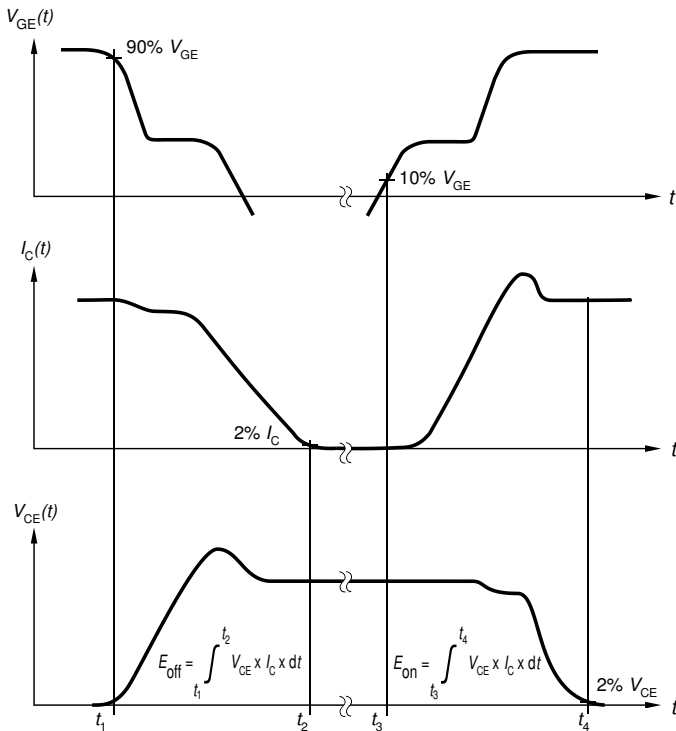

Figure B. Definition of switching losses

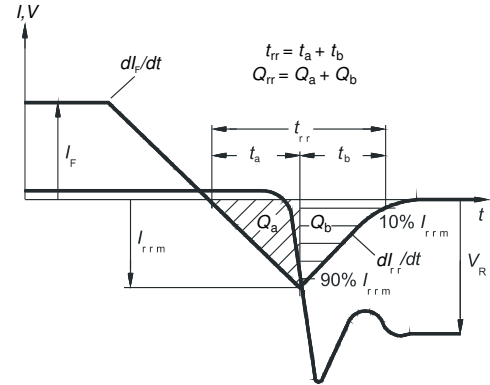

Figure C. Definition of diode switching characteristics

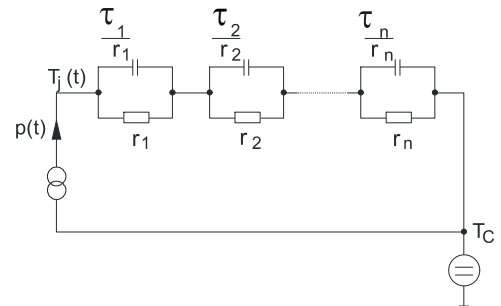

Figure D. Thermal equivalent circuit

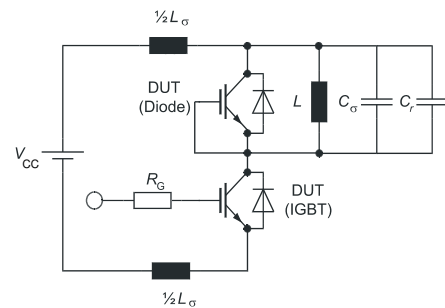

Figure E. Dynamic test circuit
Parasitic inductance L_{σ} ,
parasitic capacitor C_{σ} ,
relief capacitor C_r ,
(only for ZVT switching)

Revision History

IKW50N65SS5

Revision: 2020-07-27, Rev. 2.1

Previous Revision

Revision	Date	Subjects (major changes since last revision)
1.1	2020-03-20	Preliminary Data Sheet
2.1	2020-07-27	Final Data Sheet

Trademarks

All referenced product or service names and trademarks are the property of their respective owners.

Published by
Infineon Technologies AG
81726 München, Germany
© Infineon Technologies AG 2020.
All Rights Reserved.

Important Notice

The information given in this document shall in no event be regarded as a guarantee of conditions or characteristics ("Beschaffenheitsgarantie"). With respect to any examples, hints or any typical values stated herein and/or any information regarding the application of the product, Infineon Technologies hereby disclaims any and all warranties and liabilities of any kind, including without limitation warranties of non-infringement of intellectual property rights of any third party.

In addition, any information given in this document is subject to customer's compliance with its obligations stated in this document and any applicable legal requirements, norms and standards concerning customer's products and any use of the product of Infineon Technologies in customer's applications.

The data contained in this document is exclusively intended for technically trained staff. It is the responsibility of customer's technical departments to evaluate the suitability of the product for the intended application and the completeness of the product information given in this document with respect to such application.

For further information on the product, technology, delivery terms and conditions and prices please contact your nearest Infineon Technologies office (www.infineon.com).

Please note that this product is not qualified according to the AEC Q100 or AEC Q101 documents of the Automotive Electronics Council.

Warnings

Due to technical requirements products may contain dangerous substances. For information on the types in question please contact your nearest Infineon Technologies office.

Except as otherwise explicitly approved by Infineon Technologies in a written document signed by authorized representatives of Infineon Technologies, Infineon Technologies' products may not be used in any applications where a failure of the product or any consequences of the use thereof can reasonably be expected to result in personal injury.

单击下面可查看定价，库存，交付和生命周期等信息

[>>Infineon\(英飞凌\)](#)