

MOSFET

SIPMOS® Small-Signal-Transistor

Features

- N-channel
- Depletion mode
- dv/dt rated
- Pb-free lead plating; RoHS compliant
- Halogen-free according to IEC61249-2-21

Product validation

Fully qualified according to JEDEC for Industrial Applications

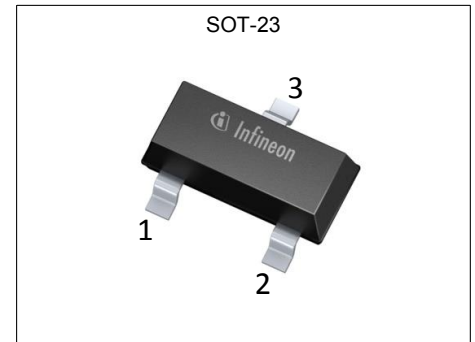
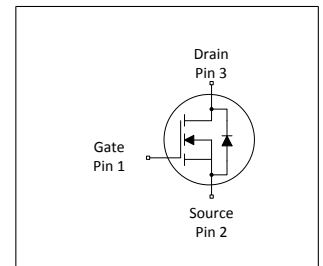

Table 1 Key Performance Parameters

Parameter	Value	Unit
V_{DS}	600	V
$R_{DS(on),max}$	700	Ω
$I_{DSS,min}$	0.007	A



RoHS

Type / Ordering Code	Package	Marking	Related Links
BSS126I	PG-SOT23	Shs	-

Table of Contents

Description	1
Maximum ratings	3
Thermal characteristics	3
Electrical characteristics	3
Electrical characteristics diagrams	5
Package Outlines	9
Revision History	10
Trademarks	10
Disclaimer	10

1 Maximum ratings

at $T_A=25\text{ °C}$, unless otherwise specified

Table 2 Maximum ratings

Parameter	Symbol	Values			Unit	Note / Test Condition
		Min.	Typ.	Max.		
Continuous drain current	I_D	-	-	0.021 0.017	A	$T_A=25\text{ °C}$ $T_A=70\text{ °C}$
Pulsed drain current	$I_{D,pulse}$	-	-	0.085	A	$T_A=25\text{ °C}$
Reverse diode dv/dt	dv/dt	-	-	6	kV/ μ s	$I_D=0.016\text{ A}$, $V_{DS}=20\text{ V}$, $di/dt=200\text{ A}/\mu\text{s}$, $T_{j,max}=150\text{ °C}$
Gate source voltage	V_{GS}	-20	-	20	V	-
ESD sensitivity (HBM) as per JESD22-A114	-	-	-	Class 0 ($<250\text{V}$)	-	-
Power dissipation	P_{tot}	-	-	0.50	W	$T_A=25\text{ °C}$
Operating and storage temperature	T_j, T_{stg}	-55	-	150	$^{\circ}\text{C}$	-

2 Thermal characteristics

Table 3 Thermal characteristics

Parameter	Symbol	Values			Unit	Note / Test Condition
		Min.	Typ.	Max.		
Thermal resistance, junction - ambient, minimal footprint	R_{thJA}	-	-	250	K/W	-

3 Electrical characteristics

at $T_j=25\text{ °C}$, unless otherwise specified

Table 4 Static characteristics

Parameter	Symbol	Values			Unit	Note / Test Condition
		Min.	Typ.	Max.		
Drain-source breakdown voltage	$V_{(BR)DSS}$	600	-	-	V	$V_{GS}=-5\text{ V}$, $I_D=250\text{ }\mu\text{A}$
Gate threshold voltage	$V_{GS(th)}$	-2.7	-2.0	-1.6	V	$V_{DS}=3\text{ V}$, $I_D=8\text{ }\mu\text{A}$
Drain-source cutoff current	$I_{D(off)}$	-	-	0.1 10	μA	$V_{DS}=600\text{ V}$, $V_{GS}=-5\text{ V}$, $T_j=25\text{ °C}$ $V_{DS}=600\text{ V}$, $V_{GS}=-5\text{ V}$, $T_j=125\text{ °C}$
Gate-source leakage current	I_{GSS}	-	-	100	nA	$V_{GS}=20\text{ V}$, $V_{DS}=0\text{ V}$
On-state drain current	I_{DSS}	7	-	-	mA	$V_{GS}=0\text{ V}$, $V_{DS}=25\text{ V}$
Drain-source on-state resistance	$R_{DS(on)}$	-	320 280	700 500	Ω	$V_{GS}=0\text{ V}$, $I_D=3\text{ mA}$ $V_{GS}=10\text{ V}$, $I_D=16\text{ mA}$
Transconductance	g_{fs}	0.008	0.017	-	S	$ V_{DS} >2 I_D R_{DS(on)max}$, $I_D=0.01\text{ A}$

Table 5 Dynamic characteristics

Parameter	Symbol	Values			Unit	Note / Test Condition
		Min.	Typ.	Max.		
Input capacitance	C_{iss}	-	21	-	pF	$V_{GS}=-5\text{ V}$, $V_{DS}=25\text{ V}$, $f=1\text{ MHz}$
Output capacitance	C_{oss}	-	2.4	-	pF	$V_{GS}=-5\text{ V}$, $V_{DS}=25\text{ V}$, $f=1\text{ MHz}$
Reverse transfer capacitance	C_{rss}	-	1.0	-	pF	$V_{GS}=-5\text{ V}$, $V_{DS}=25\text{ V}$, $f=1\text{ MHz}$
Turn-on delay time	$t_{d(on)}$	-	6.1	-	ns	$V_{DD}=300\text{ V}$, $V_{GS}=-3\text{ to }7\text{ V}$, $I_D=0.01\text{ A}$, $R_G=6\ \Omega$
Rise time	t_r	-	9.7	-	ns	$V_{DD}=300\text{ V}$, $V_{GS}=-3\text{ to }7\text{ V}$, $I_D=0.01\text{ A}$, $R_G=6\ \Omega$
Turn-off delay time	$t_{d(off)}$	-	14	-	ns	$V_{DD}=300\text{ V}$, $V_{GS}=-3\text{ to }7\text{ V}$, $I_D=0.01\text{ A}$, $R_G=6\ \Omega$
Fall time	t_f	-	115	-	ns	$V_{DD}=300\text{ V}$, $V_{GS}=-3\text{ to }7\text{ V}$, $I_D=0.01\text{ A}$, $R_G=6\ \Omega$

Table 6 Gate charge characteristics

Parameter	Symbol	Values			Unit	Note / Test Condition
		Min.	Typ.	Max.		
Gate to source charge	Q_{gs}	-	0.05	-	nC	$V_{DD}=400\text{ V}$, $I_D=10\text{ mA}$, $V_{GS}=-3\text{ to }5\text{ V}$
Gate to drain charge	Q_{gd}	-	1.2	-	nC	$V_{DD}=400\text{ V}$, $I_D=10\text{ mA}$, $V_{GS}=-3\text{ to }5\text{ V}$
Gate charge total	Q_g	-	1.4	-	nC	$V_{DD}=400\text{ V}$, $I_D=10\text{ mA}$, $V_{GS}=-3\text{ to }5\text{ V}$
Gate plateau voltage	$V_{plateau}$	-	0.10	-	V	$V_{DD}=400\text{ V}$, $I_D=10\text{ mA}$, $V_{GS}=-3\text{ to }5\text{ V}$

Table 7 Reverse diode

Parameter	Symbol	Values			Unit	Note / Test Condition
		Min.	Typ.	Max.		
Diode continuous forward current	I_S	-	-	0.016	A	$T_A=25\text{ °C}$
Diode pulse current	$I_{S,pulse}$	-	-	0.064	A	$T_A=25\text{ °C}$
Diode forward voltage	V_{SD}	-	0.81	1.2	V	$V_{GS}=-5\text{ V}$, $I_F=16\text{ mA}$, $T_J=25\text{ °C}$
Reverse recovery time	t_{rr}	-	160	-	ns	$V_R=300\text{ V}$, $I_F=0.01\text{ A}$, $di_F/dt=100\text{ A}/\mu\text{s}$
Reverse recovery charge	Q_{rr}	-	13.2	-	nC	$V_R=300\text{ V}$, $I_F=0.01\text{ A}$, $di_F/dt=100\text{ A}/\mu\text{s}$

4 Electrical characteristics diagrams

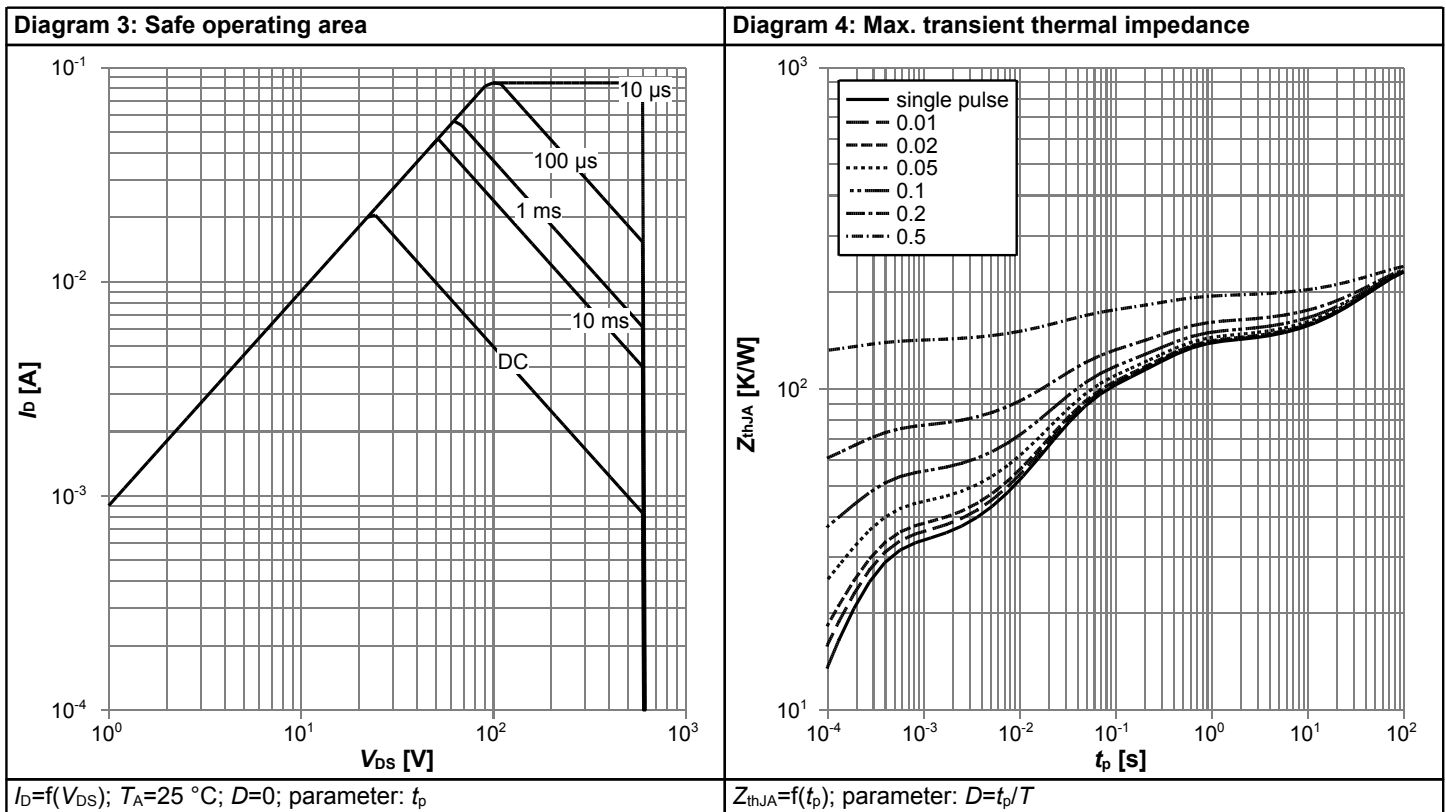
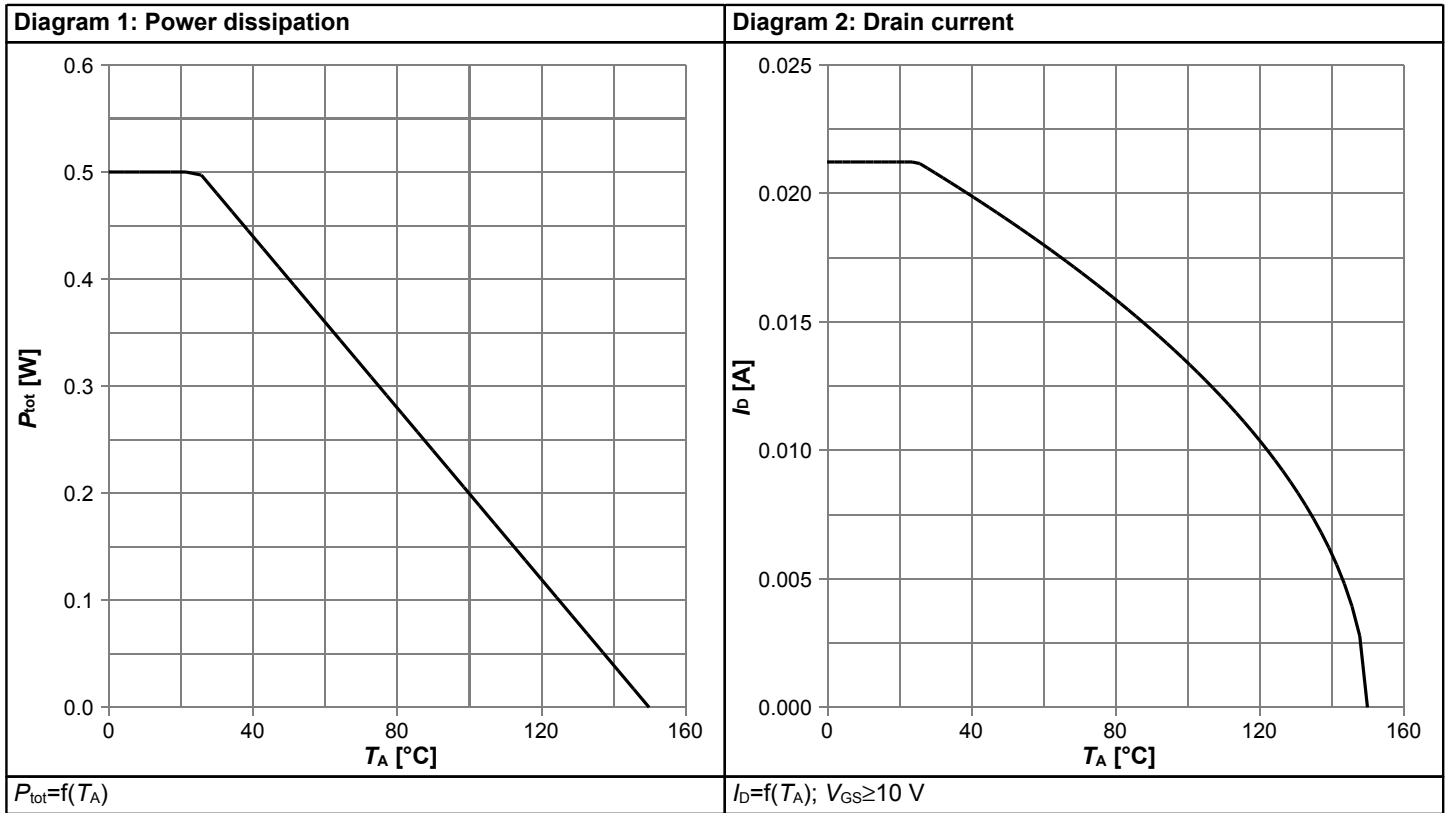
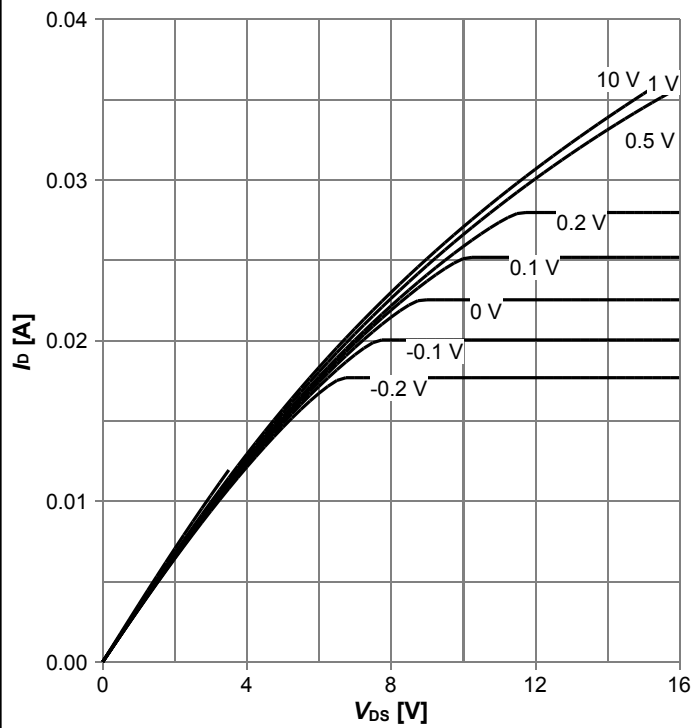
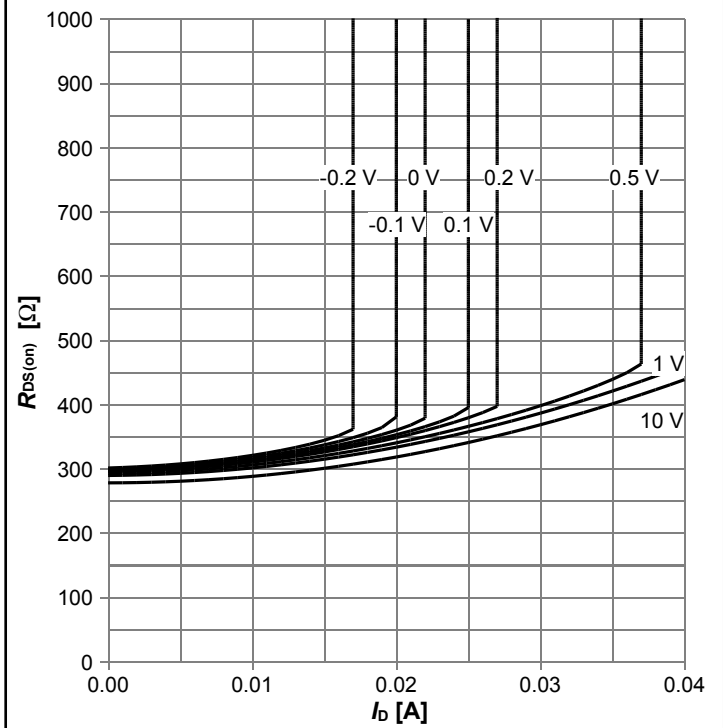

Diagram 5: Typ. output characteristics



$I_D = f(V_{DS}); T_j = 25\text{ °C}; \text{parameter: } V_{GS}$

Diagram 6: Typ. drain-source on resistance



$R_{DS(on)} = f(I_D); T_j = 25\text{ °C}; \text{parameter: } V_{GS}$

Diagram 7: Typ. transfer characteristics

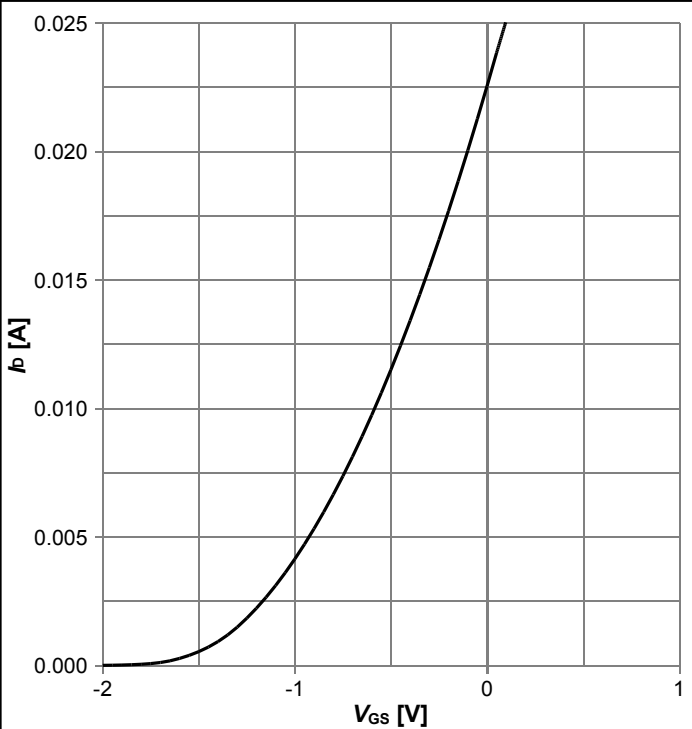

$I_D = f(V_{GS}); V_{DS} = 10\text{ V}; T_j = 25\text{ °C}$

Diagram 8: Typ. forward transconductance

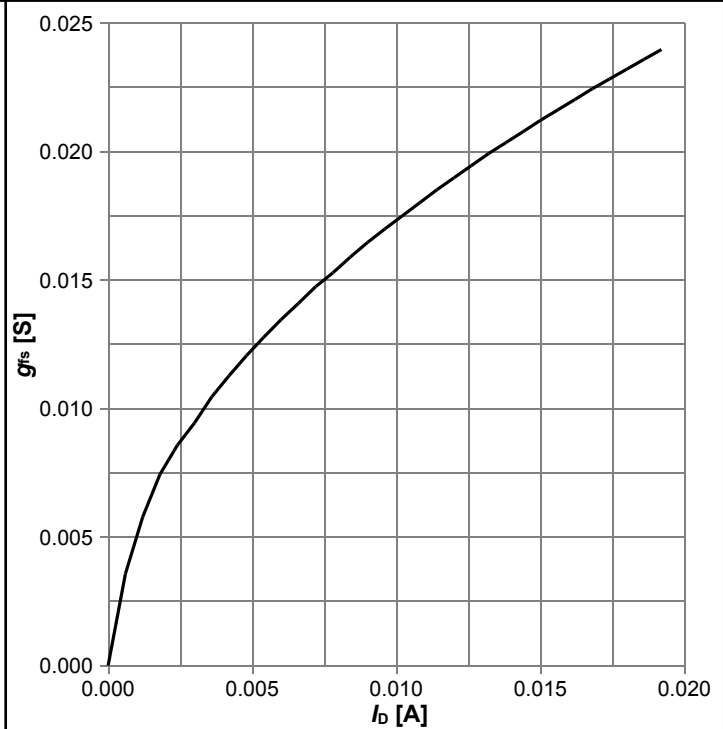

$g_{fs} = f(I_D); T_j = 25\text{ °C}$

Diagram 9: Drain-source on-state resistance

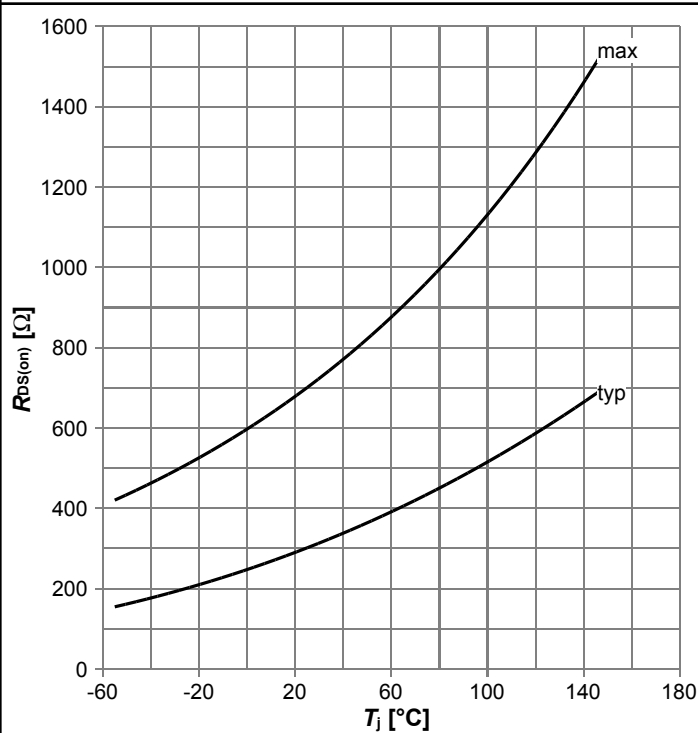

$R_{DS(on)}=f(T_j)$; $I_D=3$ mA; $V_{GS}=0$ V

Diagram 10: Typ. gate threshold voltage

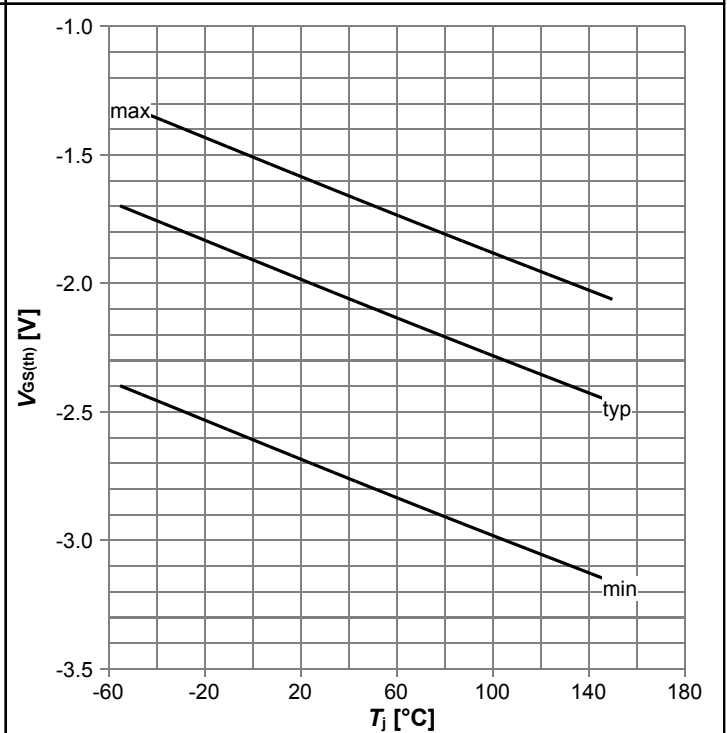

$V_{GS(th)}=f(T_j)$; $V_{DS}=3$ V; $I_D=8$ μA; parameter: I_D

Diagram 11: Typ. capacitances

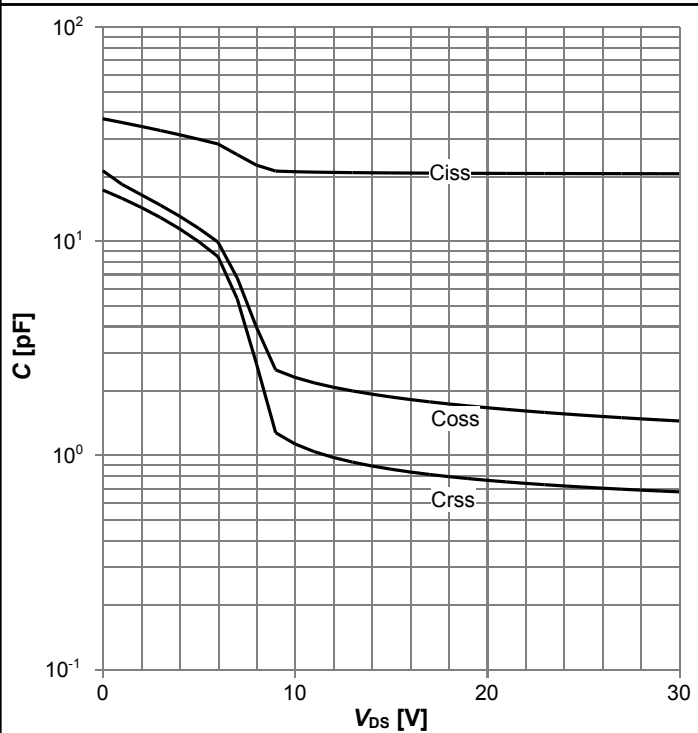

$C=f(V_{DS})$; $V_{GS}=-3$ V; $f=1$ MHz

Diagram 12: Forward characteristics of reverse diode

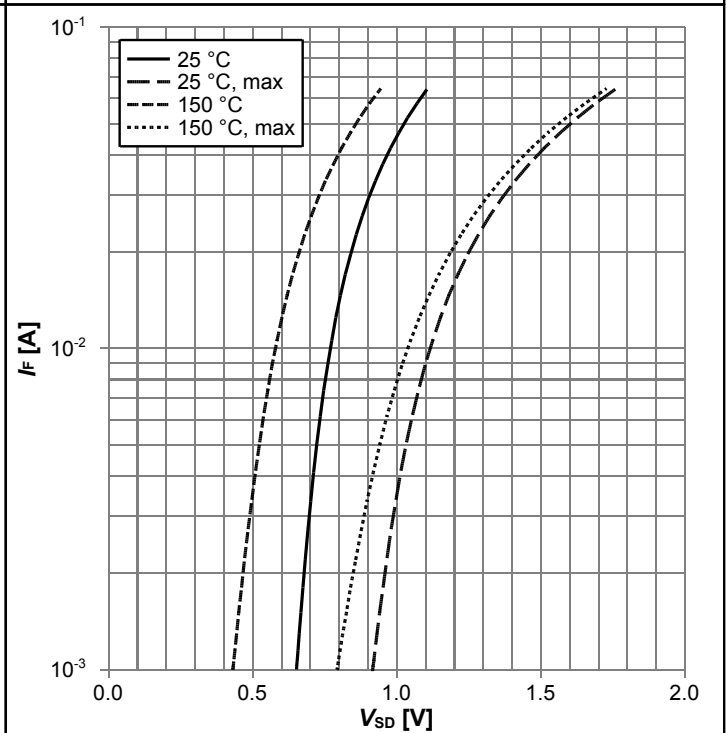

$I_F=f(V_{SD})$; parameter: T_j

Diagram 13: Typ. gate charge

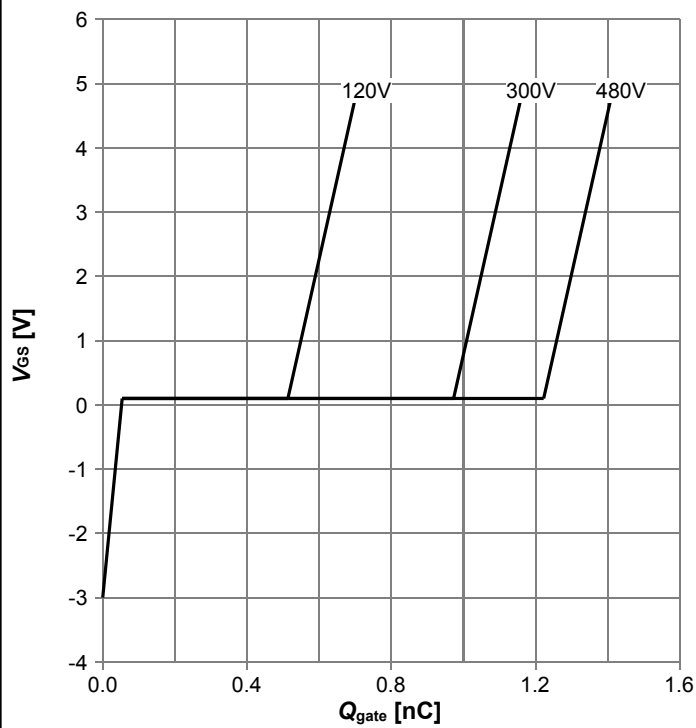

$V_{GS}=f(Q_{gate}); I_D=0.01\text{ A pulsed}; \text{parameter: } V_{DD}$

Diagram 14: Drain-source breakdown voltage

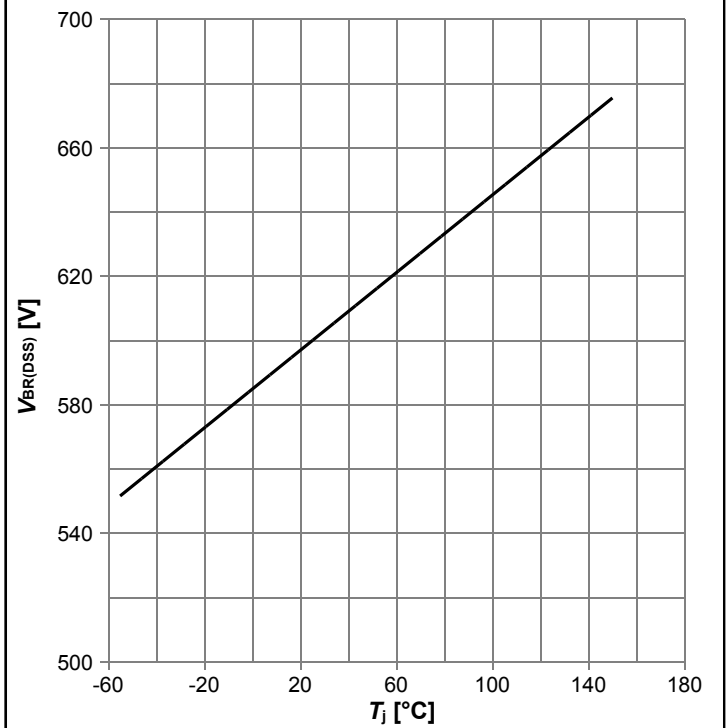

$I_D=f(V_{GS}); V_{GS}=-3\text{ V}; T_j=25\text{ °C}$

Diagram Gate charge waveforms

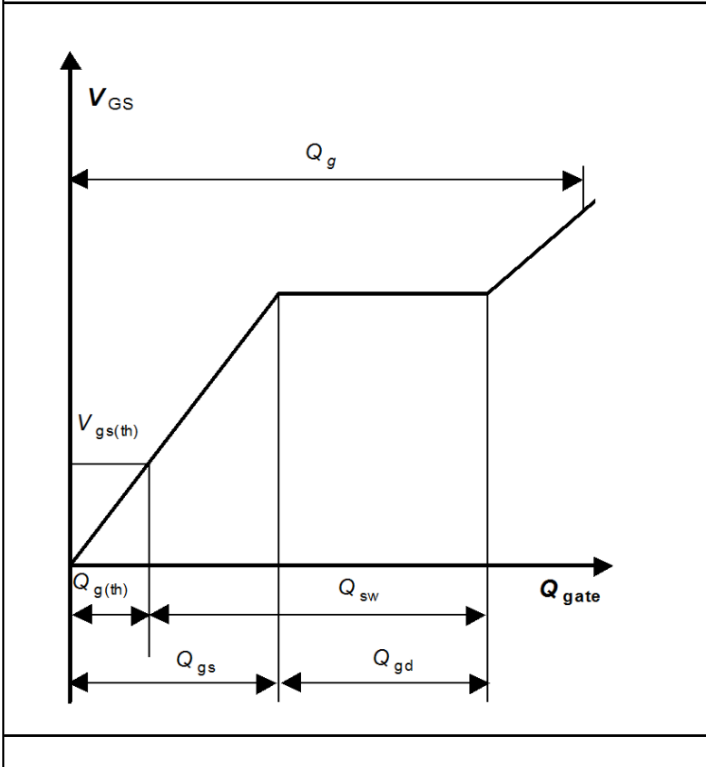

5 Package Outlines

Package Outline

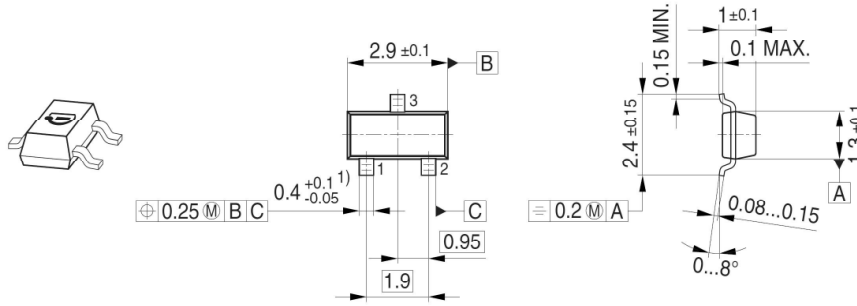

1) Lead width can be 0.6 max. in dambar area

Foot Print

Soldering Type: Reflow Soldering

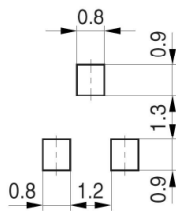

Soldering Type: Wave Soldering

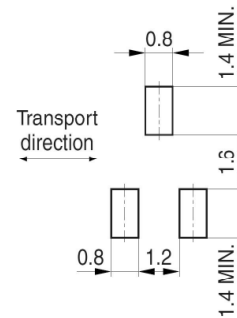

Marking Layout (Example)

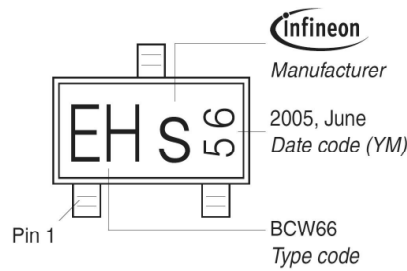

Tape and Reel

Reel ϕ 180 mm: 3.000 Pieces/Reel
 Reels/Box: 1 x 3.000 = 3.000
 Reels/Box: 10 x 3.000 = 30.000

Reel ϕ 330 mm: 10.000 Pieces/Reel
 Reels/Box: 1 x 10.000 = 10.000

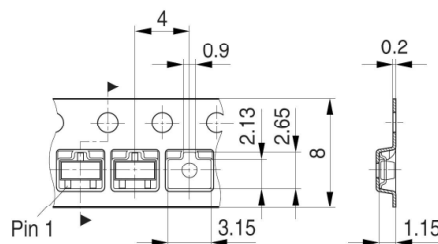

Figure 1 Outline PG-SOT23, dimensions in mm

Revision History

BSS126I

Revision: 2020-11-30, Rev. 2.1

Previous Revision

Revision	Date	Subjects (major changes since last revision)
2.0	2020-06-02	Release of final version
2.1	2020-11-30	Update Marking and typos

Trademarks

All referenced product or service names and trademarks are the property of their respective owners.

We Listen to Your Comments

Any information within this document that you feel is wrong, unclear or missing at all? Your feedback will help us to continuously improve the quality of this document. Please send your proposal (including a reference to this document) to:

erratum@infineon.com

Published by

Infineon Technologies AG
81726 München, Germany
© 2020 Infineon Technologies AG
All Rights Reserved.

Legal Disclaimer

The information given in this document shall in no event be regarded as a guarantee of conditions or characteristics ("Beschaffenheitsgarantie").

With respect to any examples, hints or any typical values stated herein and/or any information regarding the application of the product, Infineon Technologies hereby disclaims any and all warranties and liabilities of any kind, including without limitation warranties of non-infringement of intellectual property rights of any third party.

In addition, any information given in this document is subject to customer's compliance with its obligations stated in this document and any applicable legal requirements, norms and standards concerning customer's products and any use of the product of Infineon Technologies in customer's applications.

The data contained in this document is exclusively intended for technically trained staff. It is the responsibility of customer's technical departments to evaluate the suitability of the product for the intended application and the completeness of the product information given in this document with respect to such application.

Information

For further information on technology, delivery terms and conditions and prices please contact your nearest Infineon Technologies Office (www.infineon.com).

Warnings

Due to technical requirements, components may contain dangerous substances. For information on the types in question, please contact the nearest Infineon Technologies Office.

The Infineon Technologies component described in this Data Sheet may be used in life-support devices or systems and/or automotive, aviation and aerospace applications or systems only with the express written approval of Infineon Technologies, if a failure of such components can reasonably be expected to cause the failure of that life-support, automotive, aviation and aerospace device or system or to affect the safety or effectiveness of that device or system. Life support devices or systems are intended to be implanted in the human body or to support and/or maintain and sustain and/or protect human life. If they fail, it is reasonable to assume that the health of the user or other persons may be endangered.

单击下面可查看定价，库存，交付和生命周期等信息

[>>Infineon\(英飞凌\)](#)