

BGA734L16

Low Power Tri-Band UMTS LNA (2100, 1900, 800 MHz)

Data Sheet

Revision 1.1, 2011-03-16

RF & Protection Devices

Edition 2011-03-16

**Published by
Infineon Technologies AG
81726 Munich, Germany**

**© 2011 Infineon Technologies AG
All Rights Reserved.**

Legal Disclaimer

The information given in this document shall in no event be regarded as a guarantee of conditions or characteristics. With respect to any examples or hints given herein, any typical values stated herein and/or any information regarding the application of the device, Infineon Technologies hereby disclaims any and all warranties and liabilities of any kind, including without limitation, warranties of non-infringement of intellectual property rights of any third party.

Information

For further information on technology, delivery terms and conditions and prices, please contact the nearest Infineon Technologies Office (www.infineon.com).

Warnings

Due to technical requirements, components may contain dangerous substances. For information on the types in question, please contact the nearest Infineon Technologies Office.

Infineon Technologies components may be used in life-support devices or systems only with the express written approval of Infineon Technologies, if a failure of such components can reasonably be expected to cause the failure of that life-support device or system or to affect the safety or effectiveness of that device or system. Life support devices or systems are intended to be implanted in the human body or to support and/or maintain and sustain and/or protect human life. If they fail, it is reasonable to assume that the health of the user or other persons may be endangered.

BGA734L16 Low Power Tri-Band UMTS LNA (2100, 1900, 800 MHz)

Revision History: 2011-03-16, Revision 1.1

Previous Revision: 2008-01-25, Revision 1.0

Page	Subjects (major changes since last revision)
10	Updated Logic Level Limit

Trademarks of Infineon Technologies AG

AURIX™, BlueMoon™, C166™, CanPAK™, CIPOST™, CIPURSE™, COMNEON™, EconoPACK™, CoolMOS™, CoolSET™, CORECONTROL™, CROSSAVE™, DAVE™, EasyPIM™, EconoBRIDGE™, EconoDUAL™, EconoPIM™, EiceDRIVER™, eupec™, FCOS™, HITFET™, HybridPACK™, I²RF™, ISOFACE™, IsoPACK™, MIPAQ™, ModSTACK™, my-d™, NovalithIC™, OmniTune™, OptiMOS™, ORIGA™, PRIMARION™, PrimePACK™, PrimeSTACK™, PRO-SIL™, PROFET™, RASIC™, ReverSave™, SatRIC™, SIEGET™, SINDRION™, SIPMOS™, SMARTi™, SmartLEWIS™, SOLID FLASH™, TEMPFET™, thinQ!™, TRENCHSTOP™, TriCore™, X-GOLD™, X-PMU™, XMM™, XPOSSYS™

Other Trademarks

Advance Design System™ (ADS) of Agilent Technologies, AMBA™, ARM™, MULTI-ICE™, KEIL™, PRIMECELL™, REALVIEW™, THUMB™, μVision™ of ARM Limited, UK. AUTOSAR™ is licensed by AUTOSAR development partnership. Bluetooth™ of Bluetooth SIG Inc. CAT-iq™ of DECT Forum. COLOSSUS™, FirstGPS™ of Trimble Navigation Ltd. EMV™ of EMVCo, LLC (Visa Holdings Inc.). EPCOS™ of Epcos AG. FLEXGO™ of Microsoft Corporation. FlexRay™ is licensed by FlexRay Consortium. HYPERTERMINAL™ of Hilgraeve Incorporated. IEC™ of Commission Electrotechnique Internationale. IrDA™ of Infrared Data Association Corporation. ISO™ of INTERNATIONAL ORGANIZATION FOR STANDARDIZATION. MATLAB™ of MathWorks, Inc. MAXIM™ of Maxim Integrated Products, Inc. MICROTEC™, NUCLEUS™ of Mentor Graphics Corporation. Mifare™ of NXP. MIPI™ of MIPI Alliance, Inc. MIPS™ of MIPS Technologies, Inc., USA. muRata™ of MURATA MANUFACTURING CO., MICROWAVE OFFICE™ (MWO) of Applied Wave Research Inc., OmniVision™ of OmniVision Technologies, Inc. Openwave™ Openwave Systems Inc. RED HAT™ Red Hat, Inc. RFMD™ RF Micro Devices, Inc. SIRIUS™ of Sirius Satellite Radio Inc. SOLARIS™ of Sun Microsystems, Inc. SPANSION™ of Spansion LLC Ltd. Symbian™ of Symbian Software Limited. TAIYO YUDEN™ of Taiyo Yuden Co. TEAKLITE™ of CEVA, Inc. TEKTRONIX™ of Tektronix Inc. TOKO™ of TOKO KABUSHIKI KAISHA TA. UNIX™ of X/Open Company Limited. VERILOG™, PALLADIUM™ of Cadence Design Systems, Inc. VLYNQ™ of Texas Instruments Incorporated. VXWORKS™, WIND RIVER™ of WIND RIVER SYSTEMS, INC. ZETEX™ of Diodes Zetex Limited.

Last Trademarks Update 2010-10-26

Table of Contents

	Table of Contents	4
1	Features	5
	List of Figures	7
	List of Tables	8
2	Electrical Characteristics	9
2.1	Absolute Maximum Ratings	9
2.2	Thermal Resistance	9
2.3	ESD Integrity	9
2.4	DC Characteristics	10
2.5	Band Select / Gain Control Truth Table	10
2.6	Logic Signal Characteristics; $T_A = 25\text{ }^\circ\text{C}$	11
2.7	Switching Times	11
2.8	Measured RF Characteristics UMTS Band 5	12
2.9	Measured RF Characteristics UMTS Band 2	13
2.10	Measured RF Characteristics UMTS Band 1	14
2.11	Measured Performance Low Band High Gain Mode vs. Frequency	15
2.12	Measured Performance Low Band High Gain Mode vs. Temperature	17
2.13	Measured Performance Low Band Low Gain Mode vs. Frequency	18
2.14	Measured Performance Low Band Low Gain Mode vs. Temperature	20
2.15	Measured Performance Mid Band High Gain Mode vs. Frequency	21
2.16	Measured Performance Mid Band High Gain Mode vs. Temperature	23
2.17	Measured Performance Mid Band Low Gain Mode vs. Frequency	24
2.18	Measured Performance Mid Band Low Gain Mode vs. Temperature	26
2.19	Measured Performance High Band High Gain Mode vs. Frequency	27
2.20	Measured Performance High Band High Gain Mode vs. Temperature	29
2.21	Measured Performance High Band Low Gain Mode vs. Frequency	30
2.22	Measured Performance High Band Low Gain Mode vs. Temperature	32
3	Application Circuit and Block Diagram	33
3.1	UMTS Bands 1, 2 and 5 Application Circuit Schematic	33
3.2	Pin Description	34
3.3	Application Board	35
4	Physical Characteristics	37
4.1	Package Footprint	37
4.2	Package Dimensions	38

1 Features

Main features:

- Gain: 15 / -8 dB in high / low gain
- Noise figure: 1.2 dB in high gain mode
- Low Band (5, 6, 8, FOMA800)
- Mid Band (2, 3, 9, FOMA1700)
- High Band (1, 4, 10)
- High and low gain modes support
- Supply current: 3.5 / 0.65 mA in high / low gain modes
- Standby mode (<10 μ A typ)
- 1 kV HBM ESD protection
- Small leadless TSLP-16-1 package (2.3 x 2.3 x 0.39 mm)
- Pb-free (RoHS compliant) package

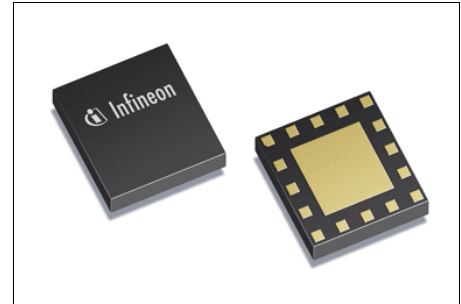

Description

The BGA734L16 is a highly flexible tri-band (2100, 1900, 850/800 MHz) low noise amplifier MMIC for worldwide use. Based on Infineon's proprietary and cost-effective SiGe:C technology, the BGA734L16 features dynamic gain control, temperature stabilization, standby mode, and 1 kV ESD protection on-chip and matching off chip. Because the matching is off chip, the 1900 MHz path can be converted into a 2100 MHz path and vice versa by optimizing the input and output matching network. This document specifies device performance for the most common band combination - UMTS bands I, II, and V.

Product Name	Package	Chip	Marking
BGA734L16	TSLP-16-1	T1520	BGA734

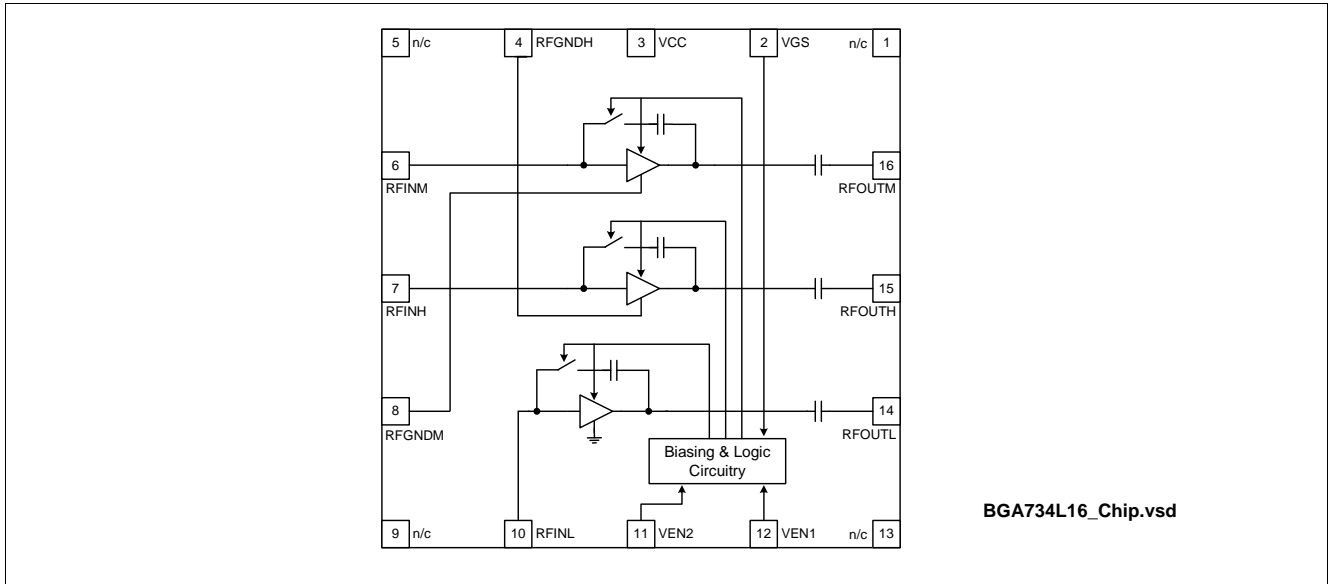

Figure 1 Block Diagram of Triple-Band LNA

List of Figures

Figure 1	Block Diagram of Triple-Band LNA.	6
Figure 2	Application Circuit with Chip Outline (Top View)	33
Figure 3	Application Board Layout on 3-layer FR4.	35
Figure 4	Cross-Section View of Application Board.	35
Figure 5	Detail of Application Board Layout	36
Figure 6	Recommended Footprint and Stencil Layout for the TSLP-16-1 Package.	37
Figure 7	Package Outline (Top, Side and Bottom View)	38

List of Tables

Table 1	Absolute Maximum Ratings	9
Table 2	Thermal Resistance	9
Table 3	ESD Integrity	9
Table 4	DC Characteristics, $T_A = -30 \dots 85 \text{ }^\circ\text{C}$	10
Table 5	Band Select Truth Table, $V_{CC} = 2.8 \text{ V}$	10
Table 6	Gain Control Truth Table, $V_{CC} = 2.8 \text{ V}$	10
Table 7	Typical Switching Times; $T_A = -30 \dots 85 \text{ }^\circ\text{C}$	11
Table 8	Typical Characteristics 800 MHz Band, $T_A = 25 \text{ }^\circ\text{C}$, $V_{CC} = 2.8 \text{ V}$	12
Table 9	Typical Characteristics 1900 MHz Band, $T_A = 25 \text{ }^\circ\text{C}$, $V_{CC} = 2.8 \text{ V}$	13
Table 10	Typical Characteristics 2100 MHz Band, $T_A = 25 \text{ }^\circ\text{C}$, $V_{CC} = 2.8 \text{ V}$	14
Table 11	Bill of Materials	33
Table 12	Pin Definition and Function	34

2 Electrical Characteristics

2.1 Absolute Maximum Ratings

Table 1 Absolute Maximum Ratings

Parameter	Symbol	Values			Unit	Note / Test Condition
		Min.	Typ.	Max.		
Supply voltage	V_{CC}	-0.3	–	3.6	V	–
Supply current	I_{CC}		–	5	mA	–
Pin voltage	V_{PIN}	-0.3	–	$V_{CC}+0.3$	V	All pins except RF input pins.
Pin voltage RF input pins	V_{RFIN}	-0.3	–	0.9	V	–
RF input power	P_{RFIN}		–	4	dBm	–
Junction temperature	T_j		–	150	°C	–
Ambient temperature range	T_A	-30	–	85	°C	–
Storage temperature range	T_{STG}	-65	–	150	°C	–

2.2 Thermal Resistance

Table 2 Thermal Resistance

Parameter	Symbol	Values			Unit	Note / Test Condition
		Min.	Typ.	Max.		
Thermal resistance junction to soldering point	R_{thJS}	–	–	≤ 110	K/W	–

2.3 ESD Integrity

Table 3 ESD Integrity

Parameter	Symbol	Values			Unit	Note / Test Condition
		Min.	Typ.	Max.		
ESD hardness HBM ¹⁾	$V_{ESD-HBM}$	–	1000	–	V	All pins

1) According to JESD22-A114

2.4 DC Characteristics

Table 4 DC Characteristics, $T_A = -30 \dots 85 \text{ }^\circ\text{C}$

Parameter	Symbol	Values			Unit	Note / Test Condition
		Min.	Typ.	Max.		
Supply voltage	V_{CC}	2.7	2.8	3.0	V	
Supply current high gain mode	I_{CCHG}	–	3.5	–	mA	All bands
Supply current low gain mode	I_{CCLG}	–	650	–	μA	All bands
Supply current standby mode	I_{CCOFF}	–	0.1	2	μA	
Logic level high	V_{HI}	1.4	2.8	–	V	VEN1 and VEN2
Logic level low	V_{LOW}	–	0.0	0.5	V	
Logic currents VEN	I_{ENL}	–	0.2	–	μA	VEN1 and VEN2
	I_{ENH}	–	10.0	–	μA	
Logic currents VGS	I_{GSL}	–	0.1	–	μA	VGS
	I_{GSH}	–	5.0	–	μA	

2.5 Band Select / Gain Control Truth Table

Table 5 Band Select Truth Table, $V_{CC} = 2.8 \text{ V}$

	Band I	Band II	Band V	Power Down
VCC	H	H	H	H
VEN1	H	H	L	L
VEN2	H	L	H	L

Table 6 Gain Control Truth Table, $V_{CC} = 2.8 \text{ V}$

	High Gain	Low Gain
VGS	H	L

2.6 Logic Signal Characteristics; $T_A = 25\text{ }^\circ\text{C}$

Current consumption of logic inputs VEN1, VEN2, VGS

Logic currents $I_{EN1,2} = f(V_{EN1,2})$
 $V_{CC} = 2.8\text{ V}$

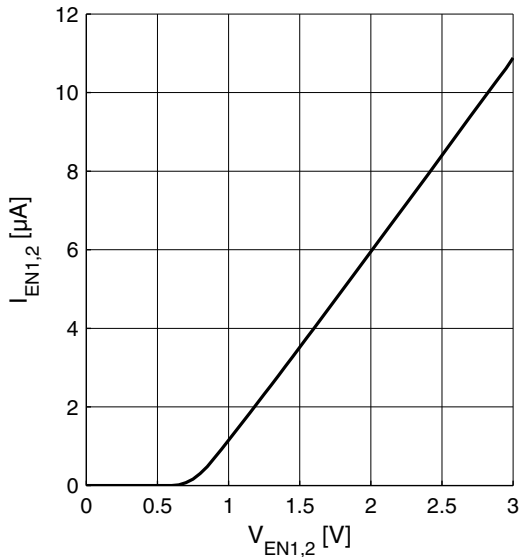

Logic currents $I_{GS} = f(V_{GS})$
 $V_{CC} = 2.8\text{ V}$

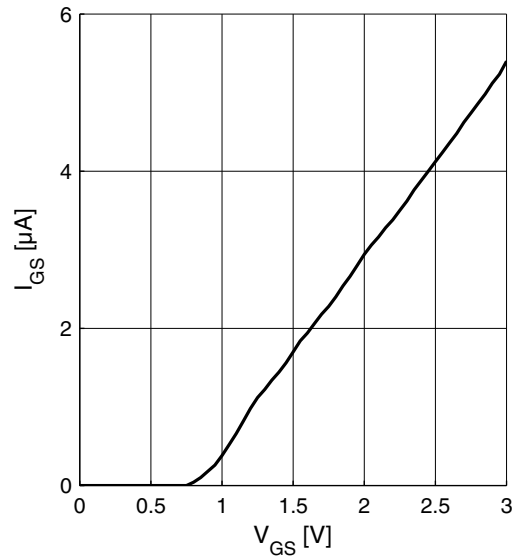

2.7 Switching Times

Table 7 Typical Switching Times; $T_A = -30 \dots 85\text{ }^\circ\text{C}$

Parameter	Symbol	Values			Unit	Note / Test Condition
		Min.	Typ.	Max.		
Gainstep settling time	t_{GS}	–	1.2	–	µs	Switching LG ↔ HG all bands
Bandselect settling time	t_{BS}	–	1.2	–	µs	Switching from any band to a different band

2.8 Measured RF Characteristics UMTS Band 5

Table 8 Typical Characteristics 800 MHz Band, $T_A = 25\text{ °C}$, $V_{CC} = 2.8\text{ V}$ ¹⁾

Parameter	Symbol	Values			Unit	Note / Test Condition
		Min.	Typ.	Max.		
Pass band range		869		894	MHz	
Input power range		-100		0	dBm	
Current consumption	I_{CCHG}	–	3.5	–	mA	High gain mode
	I_{CCLG}	–	0.65	–	mA	Low gain mode
Gain	S_{21HG}	–	15.2	–	dB	High gain mode
	S_{21LG}	–	-6.8	–	dB	Low gain mode
Reverse Isolation ²⁾	S_{12HG}	–	-34	–	dB	High gain mode
	S_{12LG}	–	-6.8	–	dB	Low gain mode
Noise figure	NF_{HG}	–	1.2	–	dB	High gain mode
	NF_{LG}	–	6.9	–	dB	Low gain mode
Input return loss ²⁾	S_{11HG}	–	-13	–	dB	50 Ω , high gain mode
	S_{11LG}	–	-18	–	dB	50 Ω , low gain mode
Output return loss ²⁾	S_{22HG}	–	-24	–	dB	50 Ω , high gain mode
	S_{22LG}	–	-11	–	dB	50 Ω , low gain mode
Stability factor ³⁾	k	–	>2.1	–	–	DC to 10 GHz; all gain modes
Input compression point ²⁾	IP_{1dBHG}	–	-12	–	dBm	High gain mode
	IP_{1dBLG}	–	-6	–	dBm	Low gain mode
Inband IIP3 ²⁾ $f_1 - f_2 = 1\text{ MHz}$ $P_{f1} = P_{f2} = -25\text{ dBm}$	$IIP3_{HG}$	–	-6	–	dBm	High gain mode
	$IIP3_{LG}$	–	5	–	dBm	Low gain mode

1) Performance based on application circuit in Figure 2 on Page 33

2) Verification based on AQL; random production test.

3) Guaranteed by device design; not tested in production.

2.9 Measured RF Characteristics UMTS Band 2

Table 9 Typical Characteristics 1900 MHz Band, $T_A = 25\text{ °C}$, $V_{CC} = 2.8\text{ V}$ ¹⁾

Parameter	Symbol	Values			Unit	Note / Test Condition
		Min.	Typ.	Max.		
Pass band range		1930		1990	MHz	
Input power range		-100		0	dBm	
Current consumption	I_{CCHG}	–	3.4	–	mA	High gain mode
	I_{CCLG}	–	0.65	–	mA	Low gain mode
Gain	S_{21HG}	–	16.5	–	dB	High gain mode
	S_{21LG}	–	-6.9	–	dB	Low gain mode
Reverse Isolation ²⁾	S_{12HG}	–	-35	–	dB	High gain mode
	S_{12LG}	–	-7	–	dB	Low gain mode
Noise figure	NF_{HG}	–	1.0	–	dB	High gain mode
	NF_{LG}	–	6.8	–	dB	Low gain mode
Input return loss ²⁾	S_{11HG}	–	-13	–	dB	50 Ω , high gain mode
	S_{11LG}	–	-12	–	dB	50 Ω , low gain mode
Output return loss ²⁾	S_{22HG}	–	-20	–	dB	50 Ω , high gain mode
	S_{22LG}	–	-17	–	dB	50 Ω , low gain mode
Stability factor ³⁾	k	–	>2.0	–	–	DC to 10 GHz; all gain modes
Input compression point ²⁾	IP_{1dBHG}	–	-10	–	dBm	High gain mode
	IP_{1dBLG}	–	-4	–	dBm	Low gain mode
Inband IIP3 ²⁾ $f_1 - f_2 = 1\text{ MHz}$ $P_{f1} = P_{f2} = -26\text{ dBm}$	$IIP3_{HG}$	–	-5	–	dBm	High gain mode
	$IIP3_{LG}$	–	6	–	dBm	Low gain mode

1) Performance based on application circuit in Figure 2 on Page 33

2) Verification based on AQL; random production test.

3) Guaranteed by device design; not tested in production.

2.10 Measured RF Characteristics UMTS Band 1

Table 10 Typical Characteristics 2100 MHz Band, $T_A = 25\text{ °C}$, $V_{CC} = 2.8\text{ V}$ ¹⁾

Parameter	Symbol	Values			Unit	Note / Test Condition
		Min.	Typ.	Max.		
Pass band range		2110		2170	MHz	
Input power range		-100		0	dBm	
Current consumption	I_{CCHG}	–	3.5	–	mA	High gain mode
	I_{CCLG}	–	0.65	–	mA	Low gain mode
Gain	S_{21HG}	–	16.5	–	dB	High gain mode
	S_{21LG}	–	-7.7	–	dB	Low gain mode
Reverse Isolation ²⁾	S_{12HG}	–	-36	–	dB	High gain mode
	S_{12LG}	–	-8	–	dB	Low gain mode
Noise figure	NF_{HG}	–	1.1	–	dB	High gain mode
	NF_{LG}	–	7.4	–	dB	Low gain mode
Input return loss ²⁾	S_{11HG}	–	-13	–	dB	50 Ω , high gain mode
	S_{11LG}	–	-27	–	dB	50 Ω , low gain mode
Output return loss ²⁾	S_{22HG}	–	-18	–	dB	50 Ω , high gain mode
	S_{22LG}	–	-9	–	dB	50 Ω , low gain mode
Stability factor ³⁾	k	–	>1.8	–	–	DC to 10 GHz; all gain modes
Input compression point ²⁾	IP_{1dBHG}	–	-11	–	dBm	High gain mode
	IP_{1dBLG}	–	-4	–	dBm	Low gain mode
Inband IIP3 ²⁾ $f_1 - f_2 = 1\text{ MHz}$ $P_{f1} = P_{f2} = -26\text{ dBm}$	$IIP3_{HG}$	–	-6	–	dBm	High gain mode
	$IIP3_{LG}$	–	7	–	dBm	Low gain mode

1) Performance based on application circuit in Figure 2 on Page 33

2) Verification based on AQL; random production test.

3) Guaranteed by device design; not tested in production.

2.11 Measured Performance Low Band High Gain Mode vs. Frequency

$T_A = 25\text{ }^\circ\text{C}$, $V_{CC} = 2.8\text{ V}$, $V_{GS} = 2.8\text{ V}$, $V_{EN1} = 0\text{ V}$, $V_{EN2} = 2.8\text{ V}$

Power Gain $|S_{21}| = f(f)$

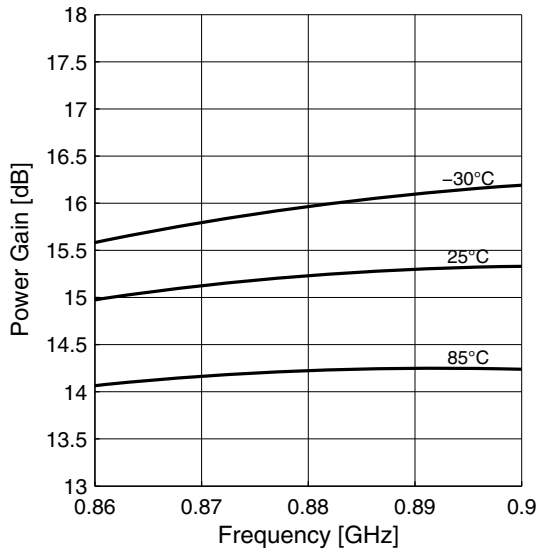

Power Gain Wideband $|S_{21}| = f(f)$

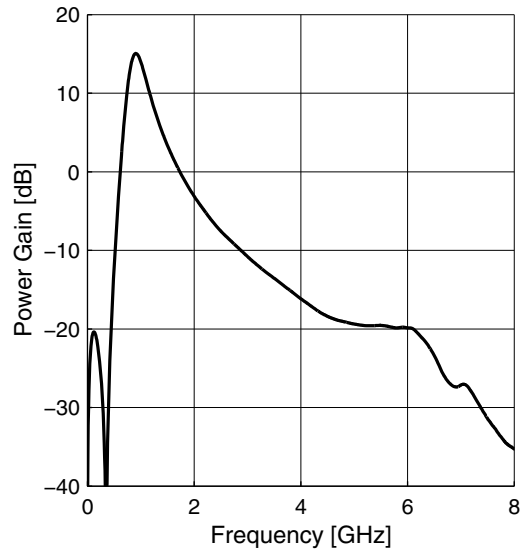

Matching $|S_{11}| = f(f)$, $|S_{22}| = f(f)$

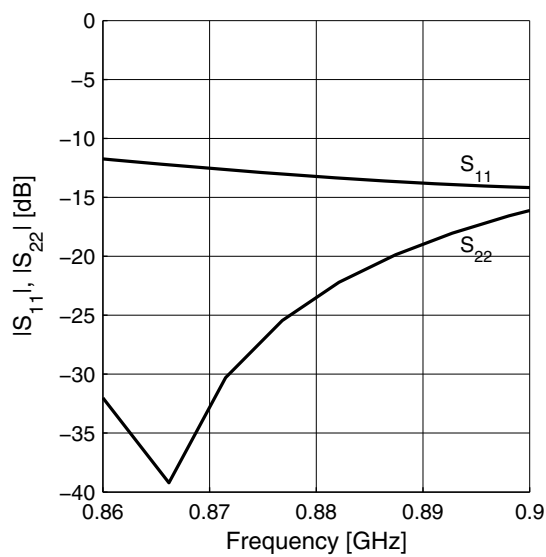

Gainstep HG - LG $\Delta S_{21} = f(f)$

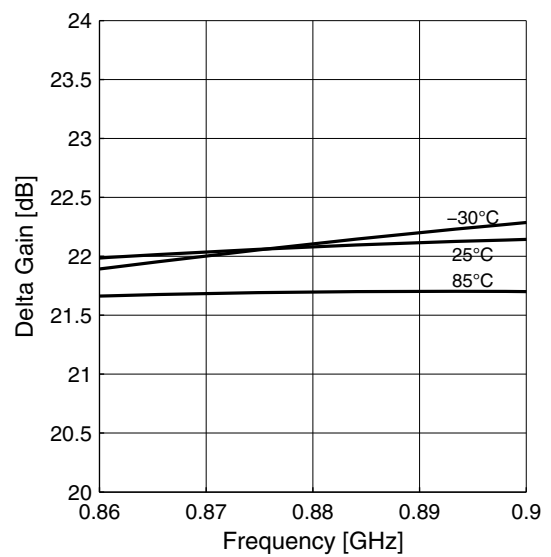

Noise Figure $NF = f(f)$

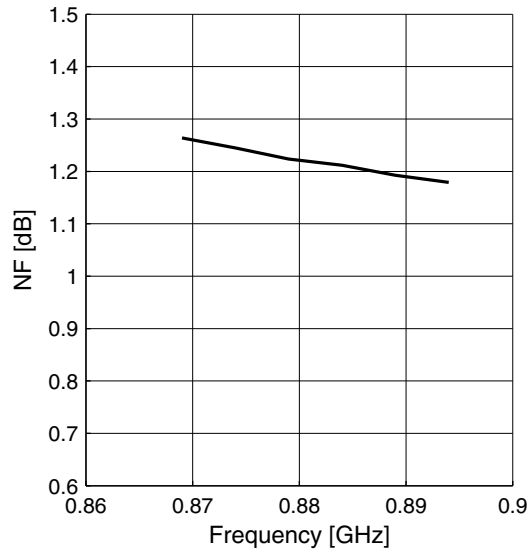

Input Compression $P_{1dB} = f(f)$

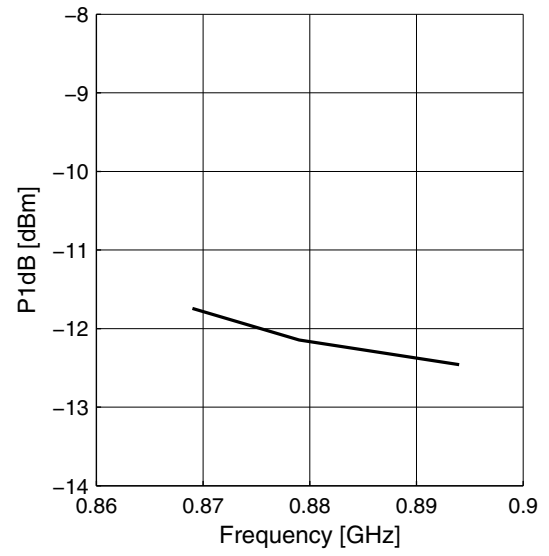

2.12 Measured Performance Low Band High Gain Mode vs. Temperature

$V_{CC} = 2.8\text{ V}$, $V_{GS} = 2.8\text{ V}$, $V_{EN1} = 0\text{ V}$, $V_{EN2} = 2.8\text{ V}$

Power Gain $|S_{21}| = f(T_A)$

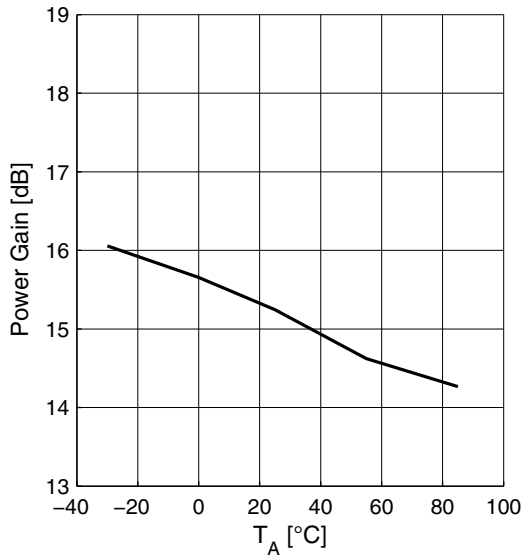

Supply Current $I_{CC} = f(T_A)$

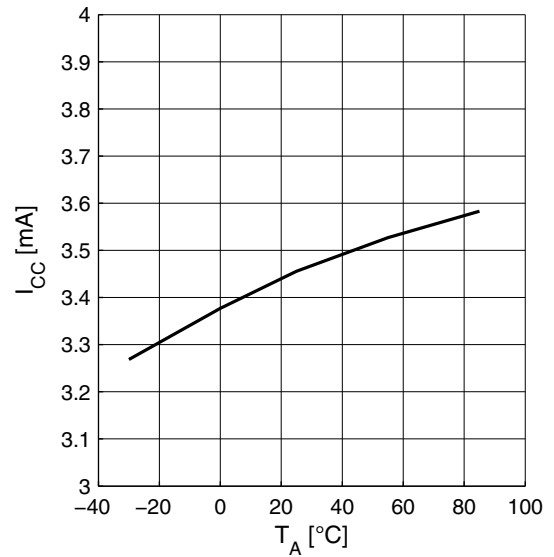

Noise Figure $NF = f(T_A)$

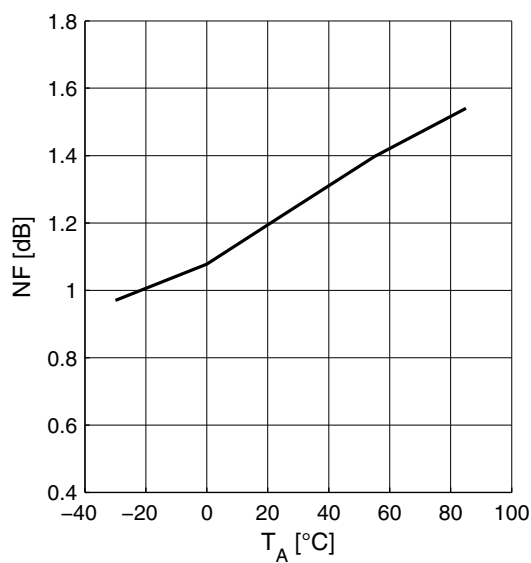

Input Compression $P_{1dB} = f(T_A)$

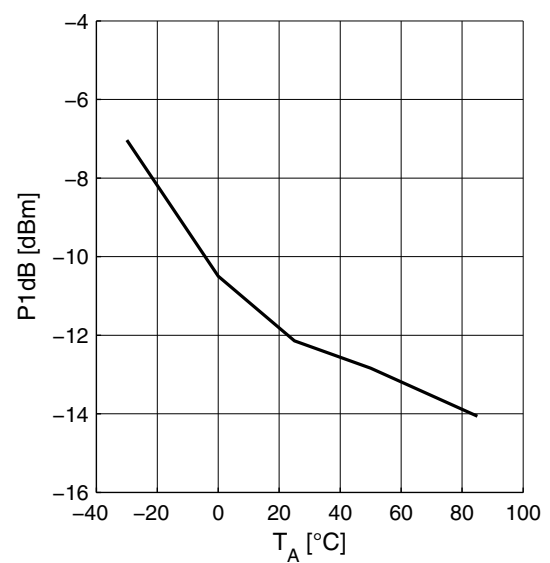

2.13 Measured Performance Low Band Low Gain Mode vs. Frequency

$T_A = 25\text{ }^\circ\text{C}$, $V_{CC} = 2.8\text{ V}$, $V_{GS} = 0\text{ V}$, $V_{EN1} = 0\text{ V}$, $V_{EN2} = 2.8\text{ V}$

Power Gain $|S_{21}| = f(f)$

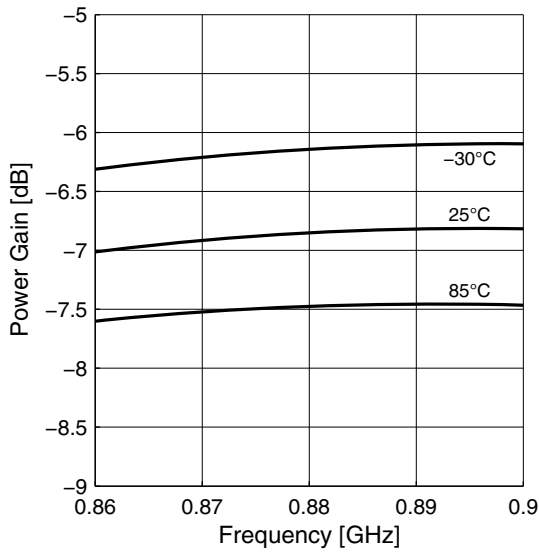

Power Gain Wideband $|S_{21}| = f(f)$

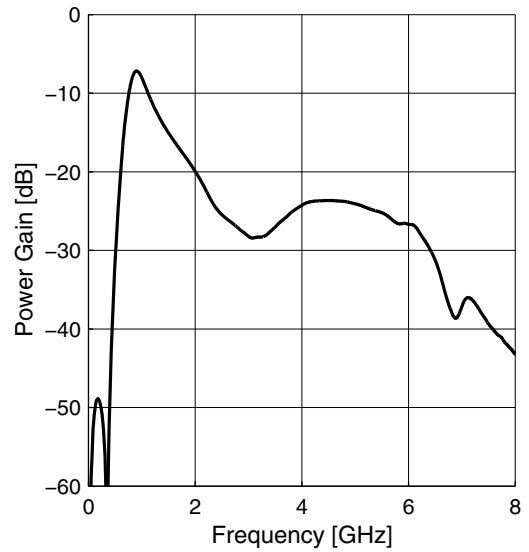

Matching $|S_{11}| = f(f)$, $|S_{22}| = f(f)$

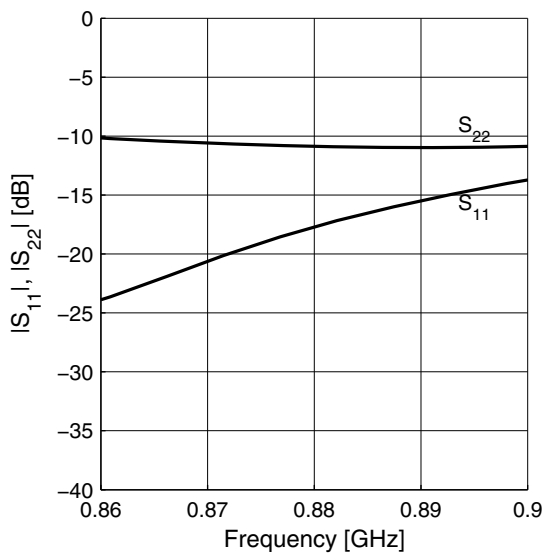

Noise Figure $NF = f(f)$

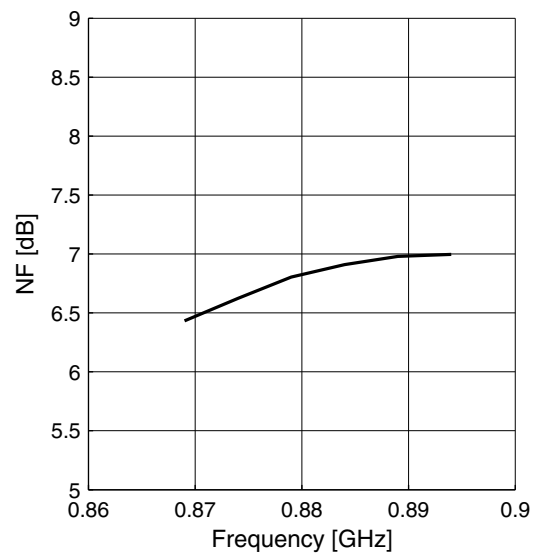

Input Compression $P_{1dB} = f(f)$

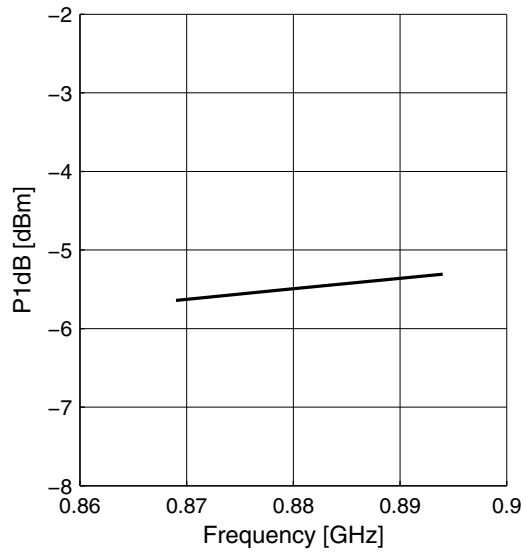

2.14 Measured Performance Low Band Low Gain Mode vs. Temperature

$V_{CC} = 2.8\text{ V}$, $V_{GS} = 0\text{ V}$, $V_{EN1} = 0\text{ V}$, $V_{EN2} = 2.8\text{ V}$

Power Gain $|S_{21}| = f(T_A)$

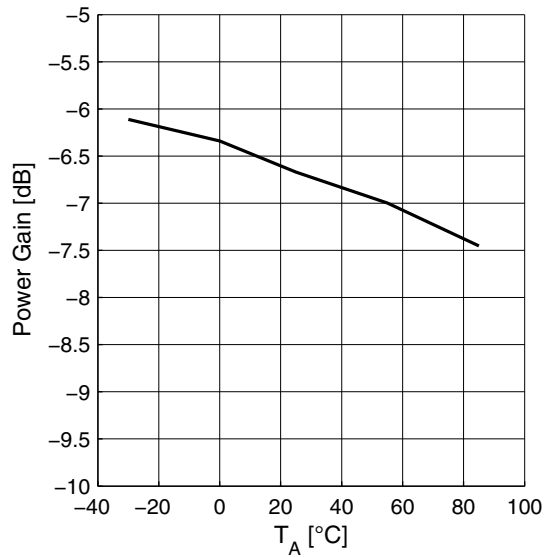

Supply Current $I_{CC} = f(T_A)$

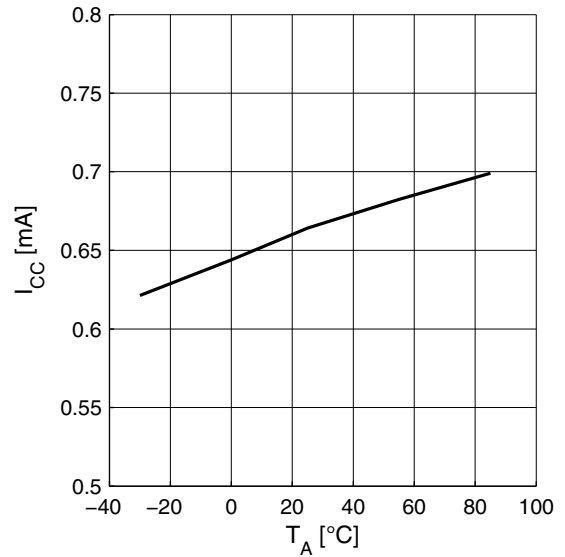

Noise Figure $NF = f(T_A)$

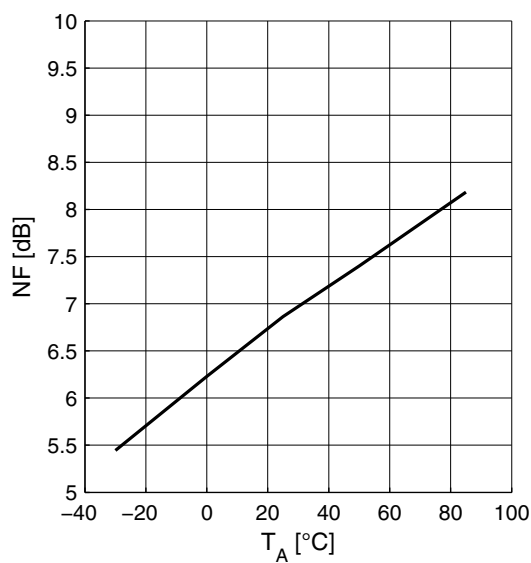

Input Compression $P_{1dB} = f(T_A)$

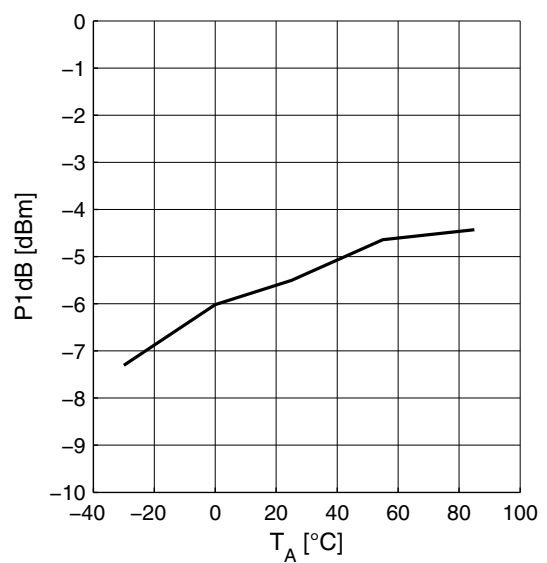

2.15 Measured Performance Mid Band High Gain Mode vs. Frequency

$T_A = 25\text{ }^\circ\text{C}$, $V_{CC} = 2.8\text{ V}$, $V_{GS} = 2.8\text{ V}$, $V_{EN1} = 2.8\text{ V}$, $V_{EN2} = 0\text{ V}$

Power Gain $|S_{21}| = f(f)$

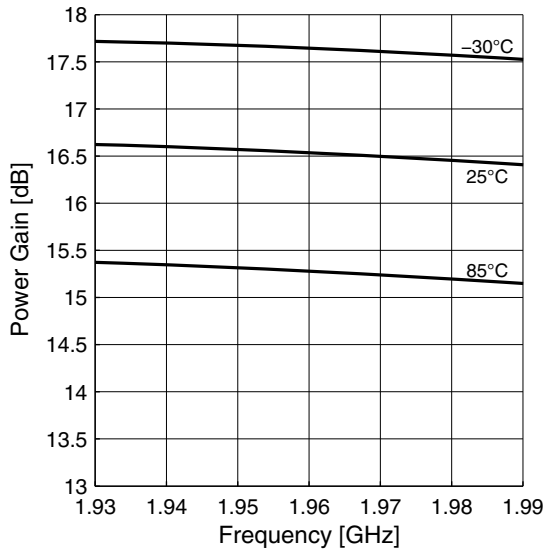

Power Gain Wideband $|S_{21}| = f(f)$

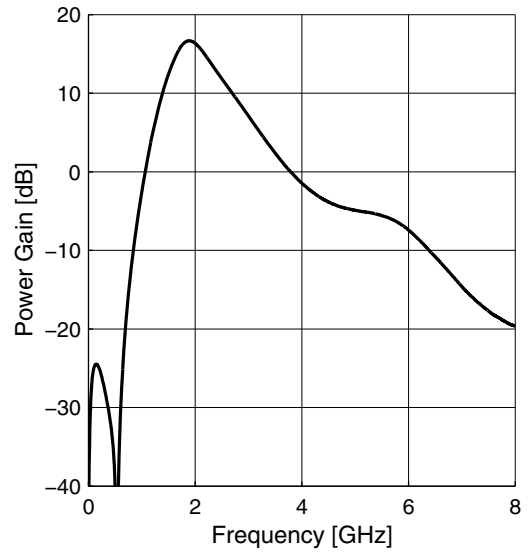

Matching $|S_{11}| = f(f)$, $|S_{22}| = f(f)$

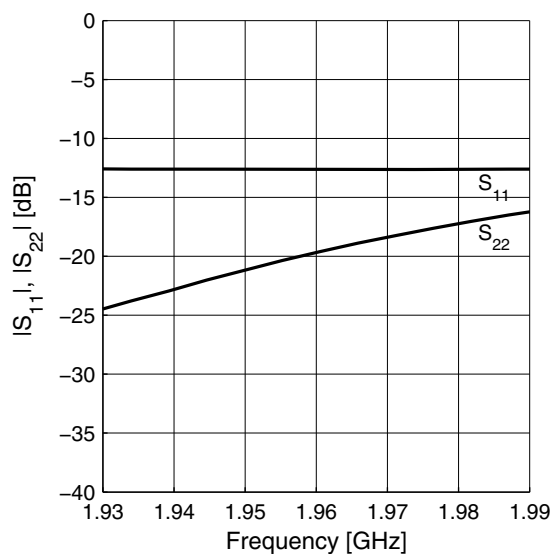

Gainstep HG - LG $\Delta S_{21} = f(f)$

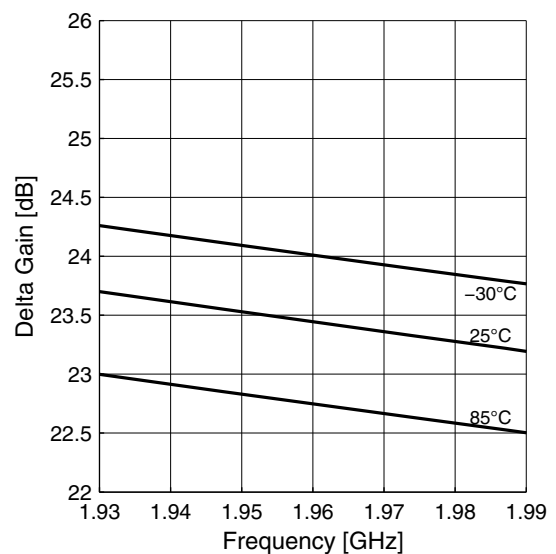

Noise Figure $NF = f(f)$

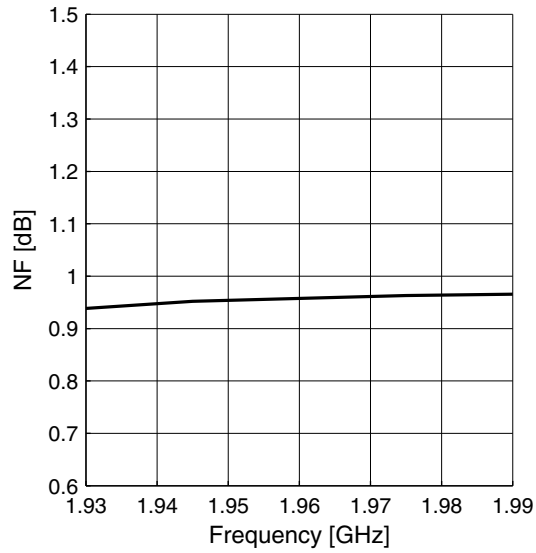

Input Compression $P_{1dB} = f(f)$

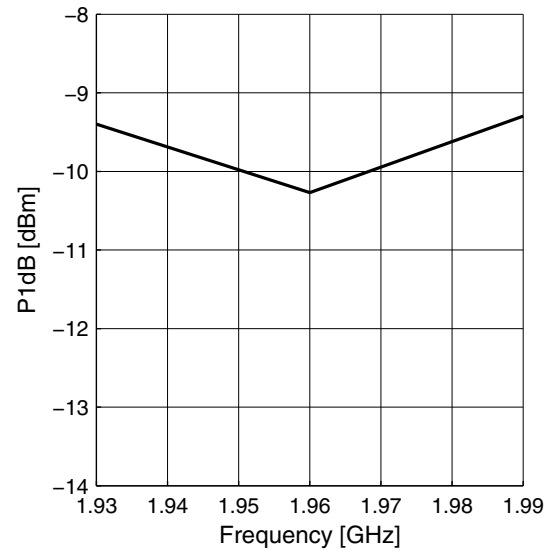

2.16 Measured Performance Mid Band High Gain Mode vs. Temperature

$V_{CC} = 2.8\text{ V}$, $V_{GS} = 2.8\text{ V}$, $V_{EN1} = 2.8\text{ V}$, $V_{EN2} = 0\text{ V}$

Power Gain $|S_{21}| = f(T_A)$

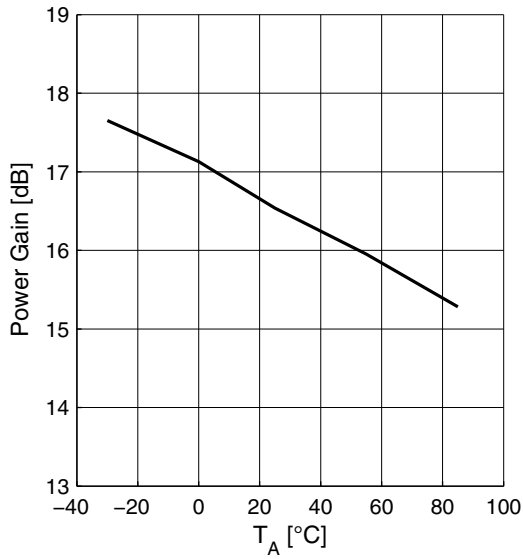

Supply Current $I_{CC} = f(T_A)$

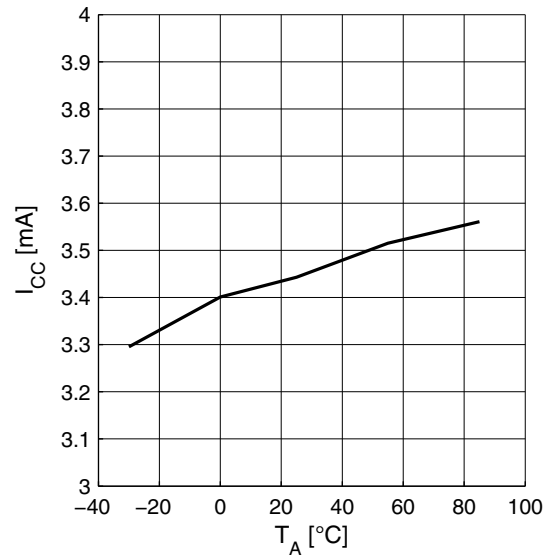

Noise Figure $NF = f(T_A)$

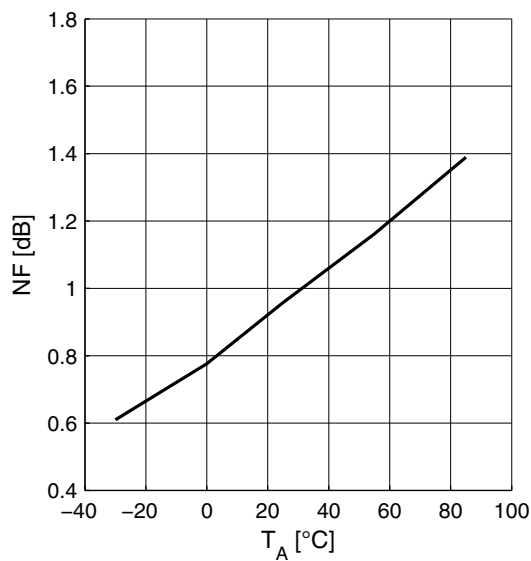

Input Compression $P_{1dB} = f(T_A)$

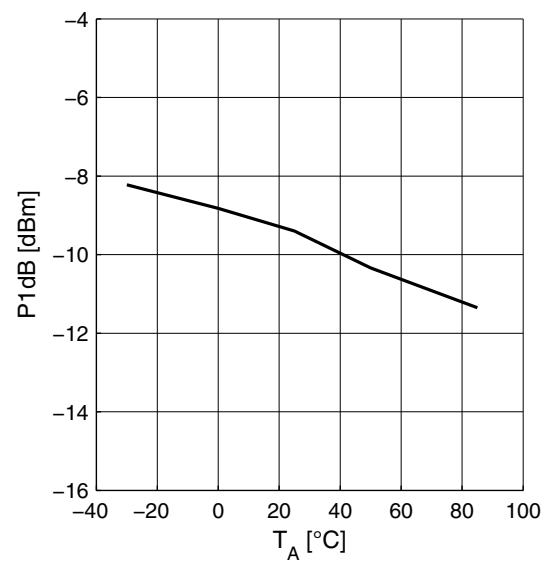

2.17 Measured Performance Mid Band Low Gain Mode vs. Frequency

$T_A = 25\text{ }^\circ\text{C}$, $V_{CC} = 2.8\text{ V}$, $V_{GS} = 0\text{ V}$, $V_{EN1} = 2.8\text{ V}$, $V_{EN2} = 0\text{ V}$

Power Gain $|S_{21}| = f(f)$

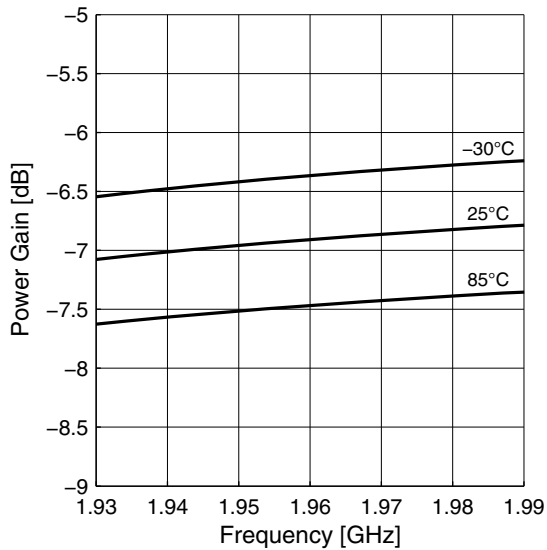

Power Gain Wideband $|S_{21}| = f(f)$

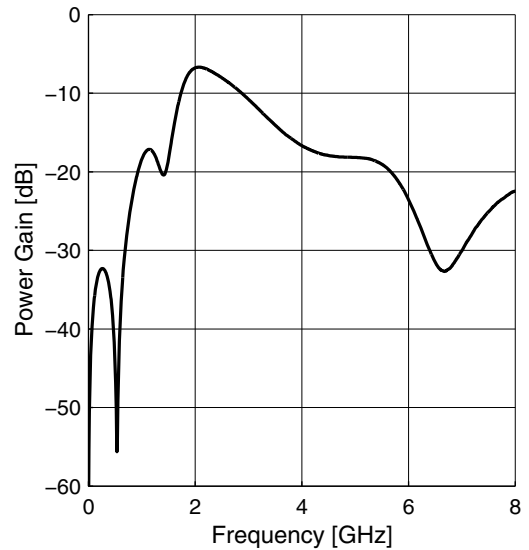

Matching $|S_{11}| = f(f)$, $|S_{22}| = f(f)$

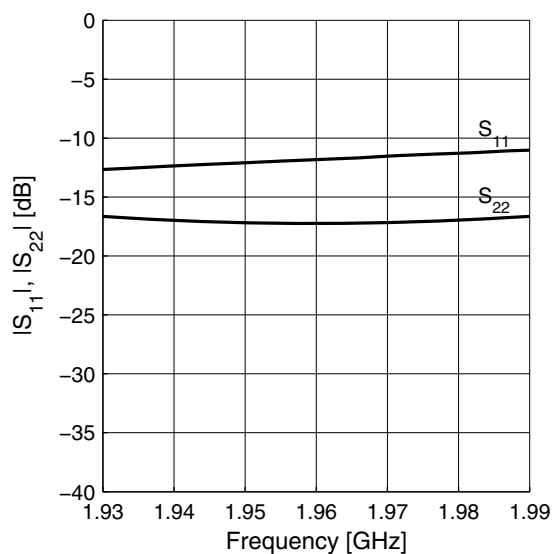

Noise Figure $NF = f(f)$

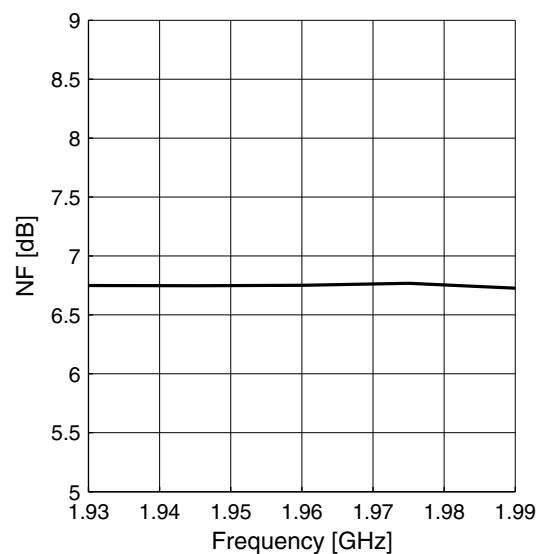

Input Compression $P_{1dB} = f(f)$

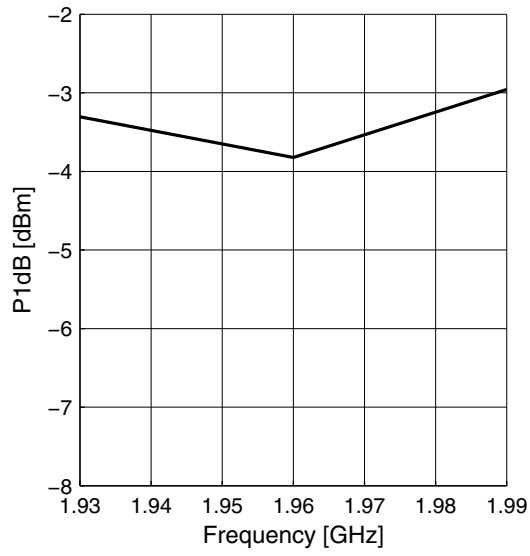

2.18 Measured Performance Mid Band Low Gain Mode vs. Temperature

$V_{CC} = 2.8\text{ V}$, $V_{GS} = 0\text{ V}$, $V_{EN1} = 2.8\text{ V}$, $V_{EN2} = 0\text{ V}$

Noise Figure $NF = f(T_A)$

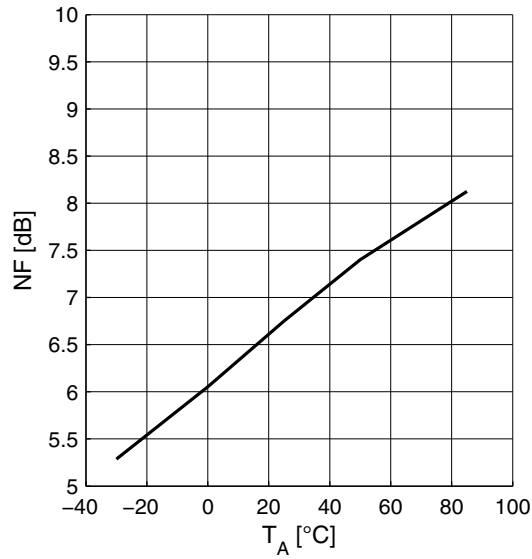

Input Compression $P_{1dB} = f(T_A)$

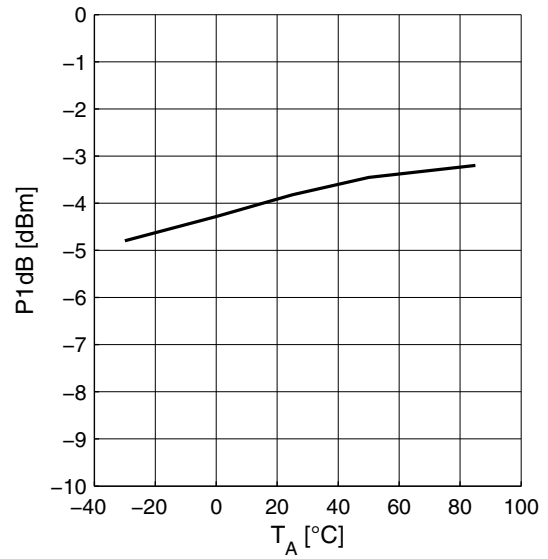

2.19 Measured Performance High Band High Gain Mode vs. Frequency

$T_A = 25\text{ }^\circ\text{C}$, $V_{CC} = 2.8\text{ V}$, $V_{GS} = 2.8\text{ V}$, $V_{EN1} = 2.8\text{ V}$, $V_{EN2} = 2.8\text{ V}$

Power Gain $|S_{21}| = f(f)$

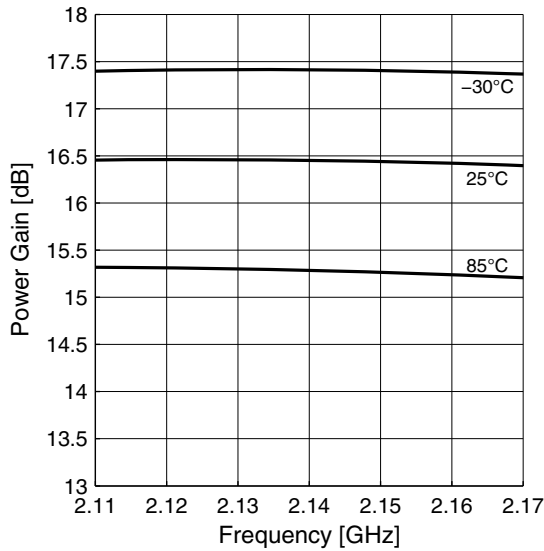

Power Gain Wideband $|S_{21}| = f(f)$

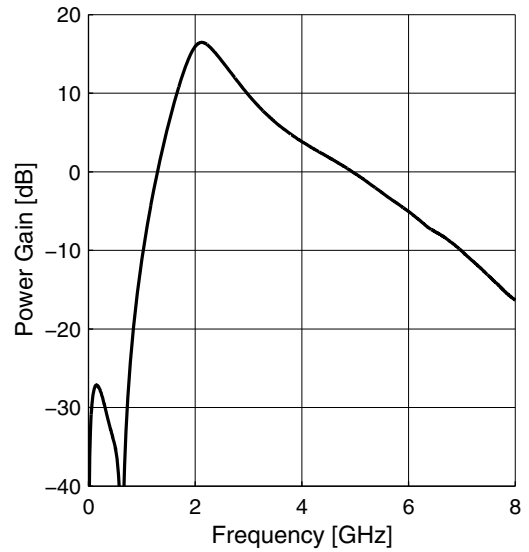

Matching $|S_{11}| = f(f)$, $|S_{22}| = f(f)$

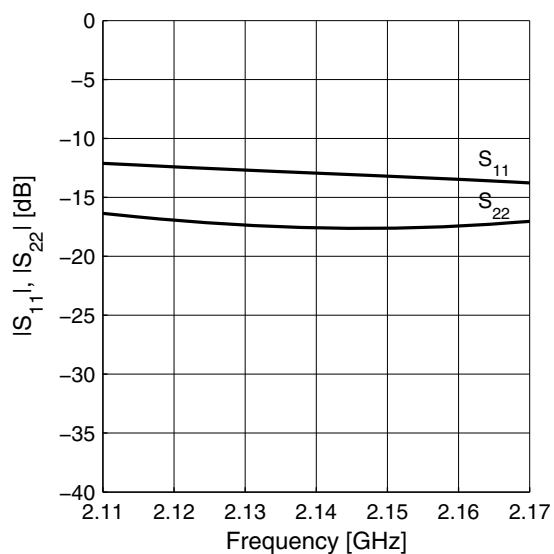

Gainstep HG - LG $\Delta S_{21} = f(f)$

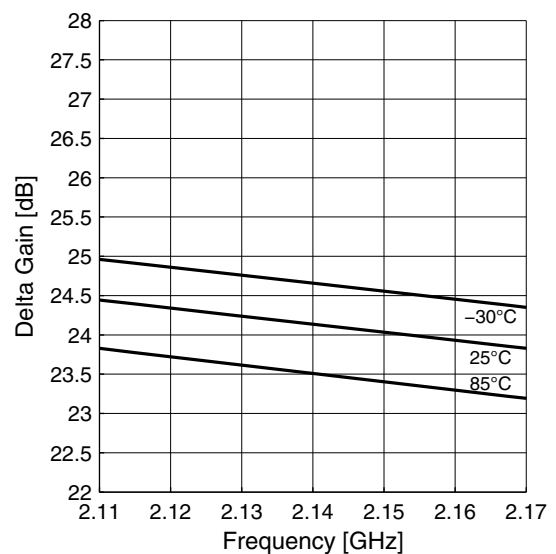

Noise Figure $NF = f(f)$

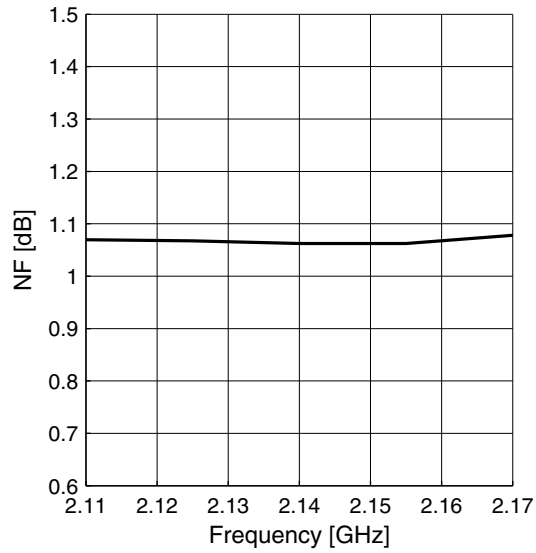

Input Compression $P_{1dB} = f(f)$

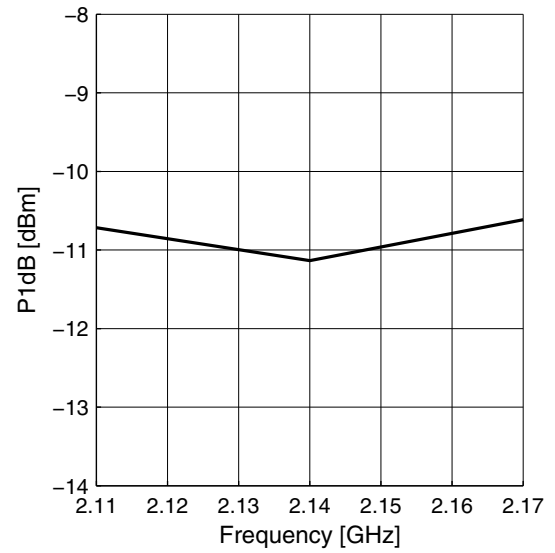

2.20 Measured Performance High Band High Gain Mode vs. Temperature

$V_{CC} = 2.8\text{ V}$, $V_{GS} = 2.8\text{ V}$, $V_{EN1} = 2.8\text{ V}$, $V_{EN2} = 2.8\text{ V}$

Power Gain $|S_{21}| = f(T_A)$

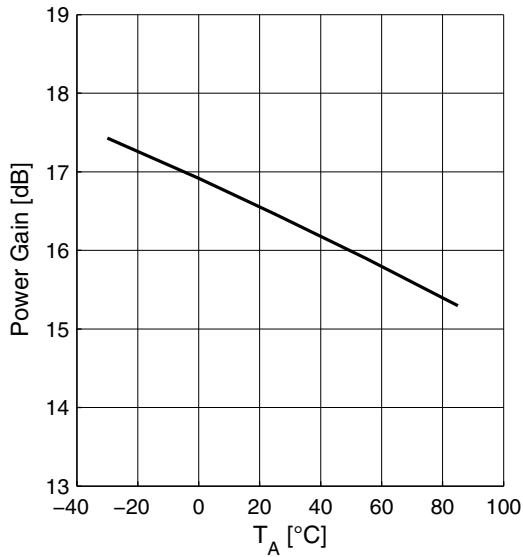

Supply Current $I_{CC} = f(T_A)$

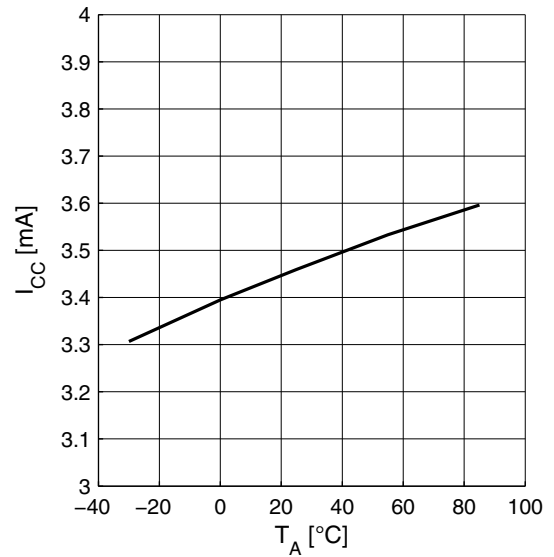

Noise Figure $NF = f(T_A)$

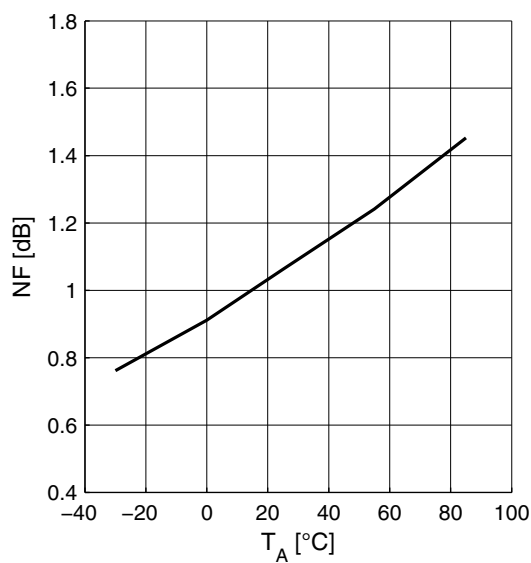

Input Compression $P_{1dB} = f(T_A)$

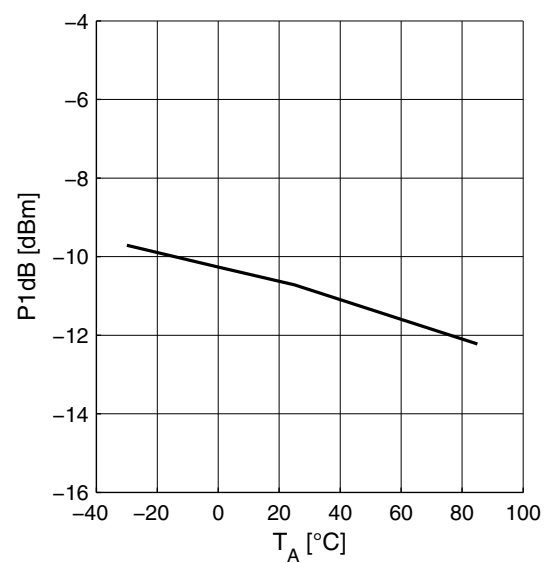

2.21 Measured Performance High Band Low Gain Mode vs. Frequency

$T_A = 25\text{ }^\circ\text{C}$, $V_{CC} = 2.8\text{ V}$, $V_{GS} = 0\text{ V}$, $V_{EN1} = 2.8\text{ V}$, $V_{EN2} = 2.8\text{ V}$

Power Gain $|S_{21}| = f(f)$

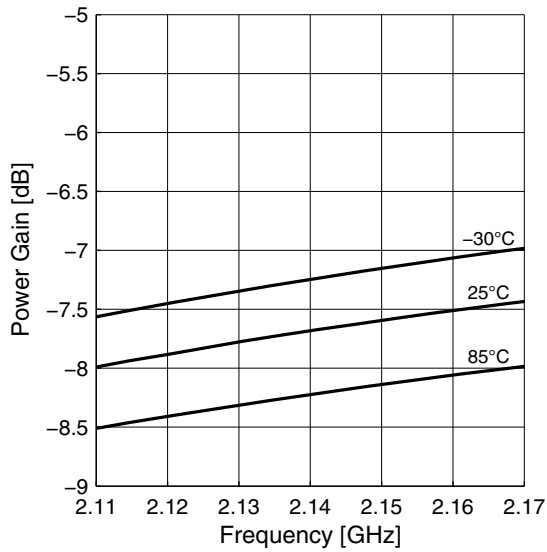

Power Gain Wideband $|S_{21}| = f(f)$

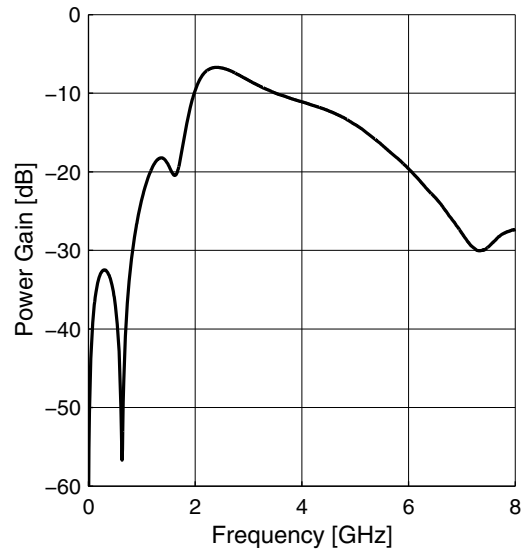

Matching $|S_{11}| = f(f)$, $|S_{22}| = f(f)$

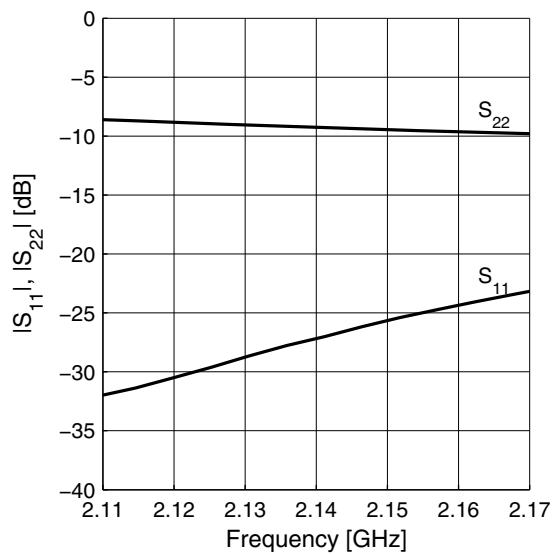

Noise Figure $NF = f(f)$

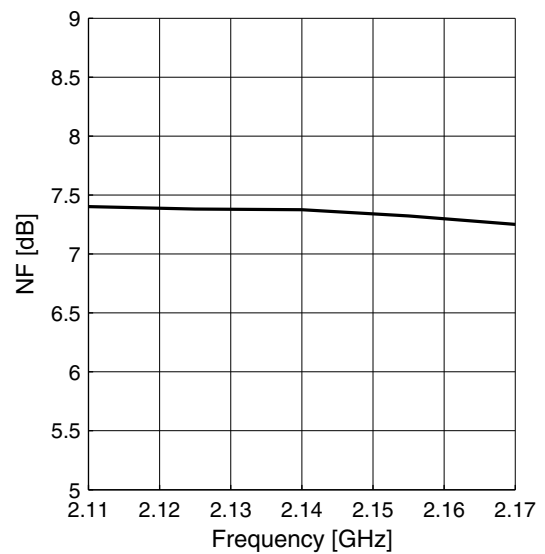

Input Compression $P_{1dB} = f(f)$

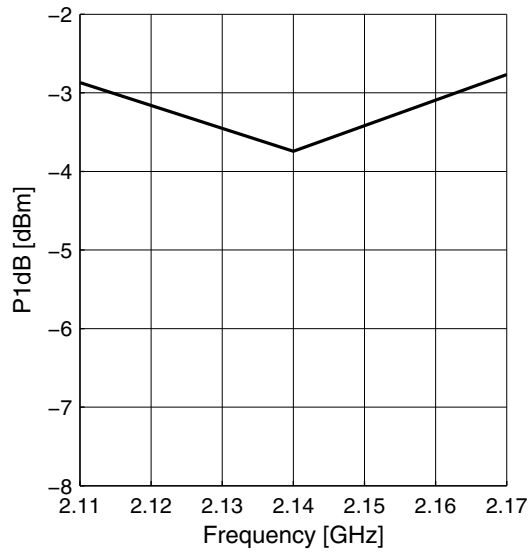

2.22 Measured Performance High Band Low Gain Mode vs. Temperature

$V_{CC} = 2.8\text{ V}$, $V_{GS} = 0\text{ V}$, $V_{EN1} = 2.8\text{ V}$, $V_{EN2} = 2.8\text{ V}$

Power Gain $|S_{21}| = f(T_A)$

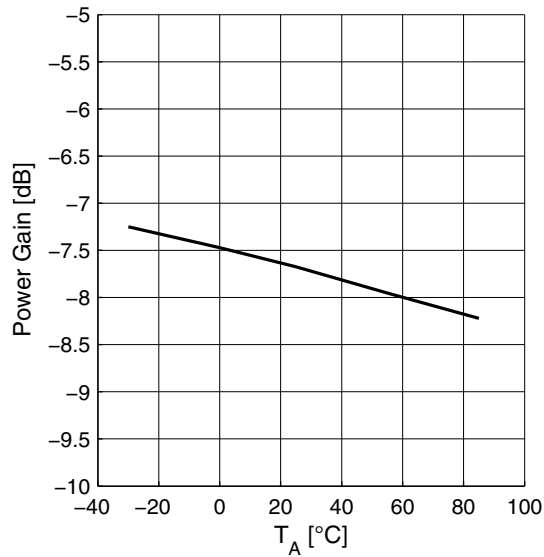

Supply Current $I_{CC} = f(T_A)$

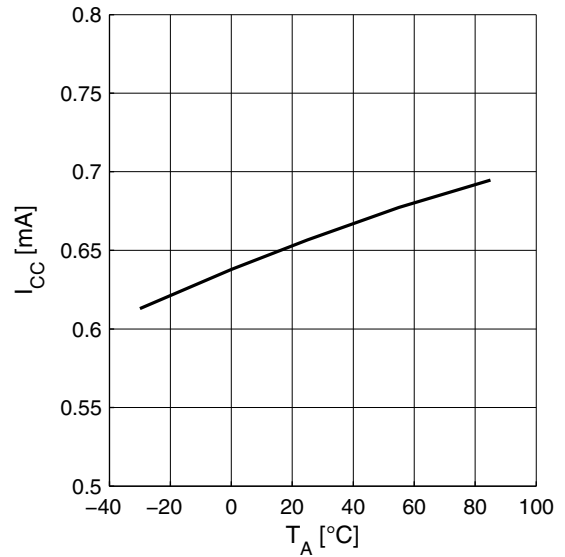

Noise Figure $NF = f(T_A)$

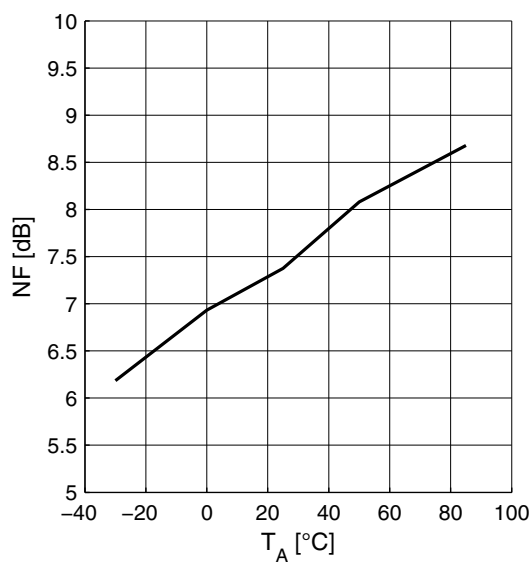

Input Compression $P_{1dB} = f(T_A)$

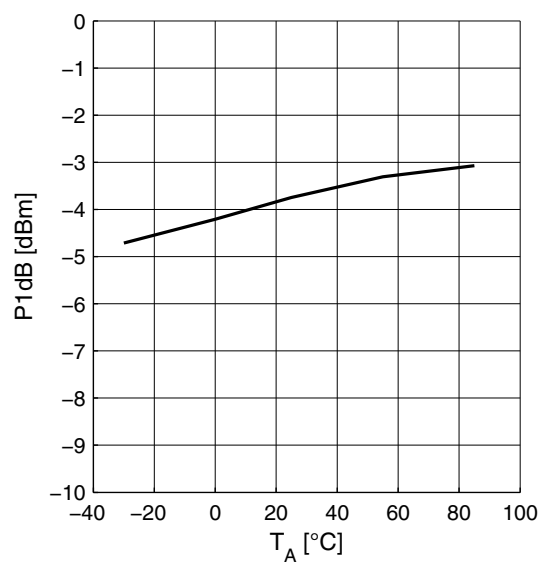

3 Application Circuit and Block Diagram

3.1 UMTS Bands 1, 2 and 5 Application Circuit Schematic

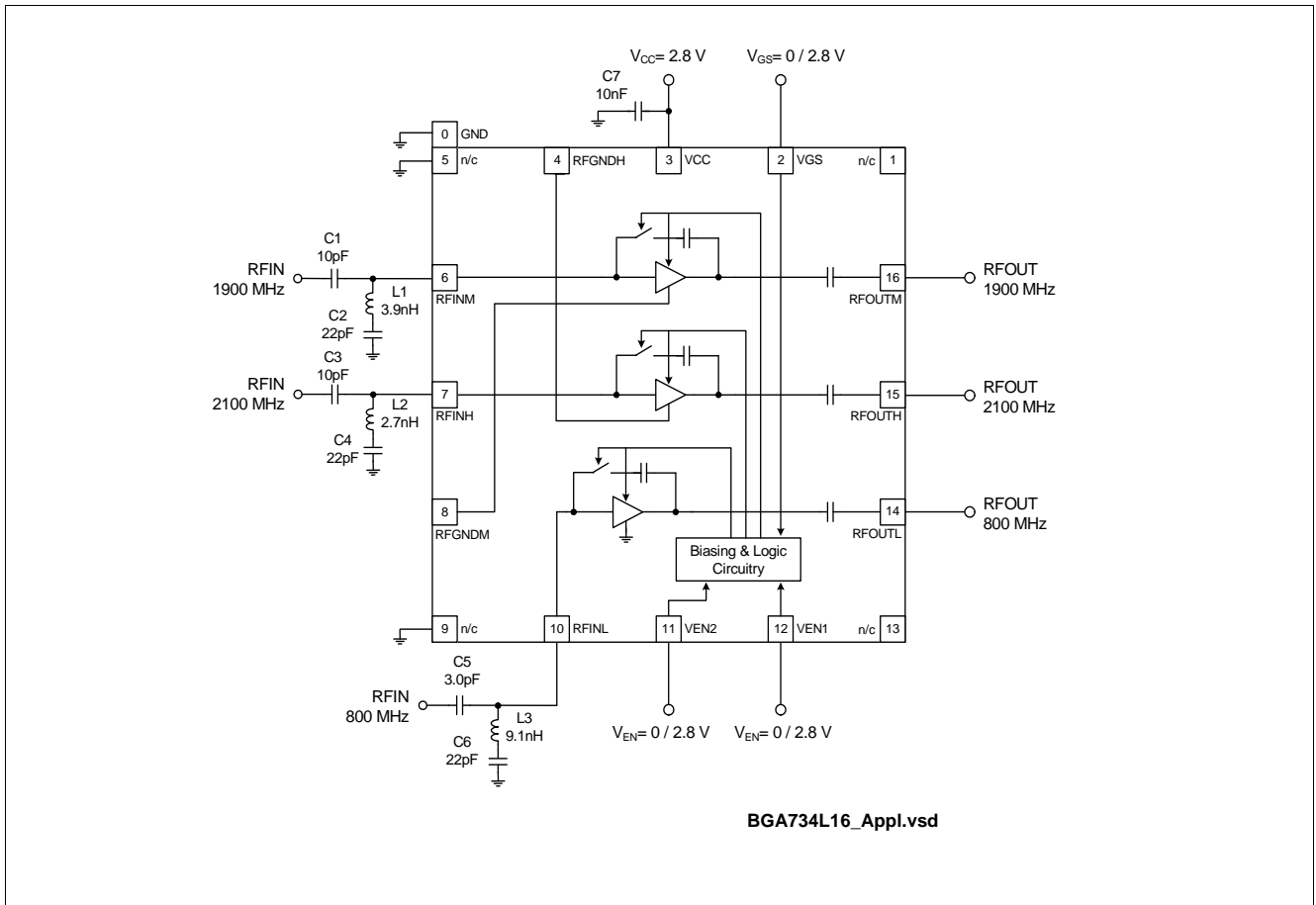

Figure 2 Application Circuit with Chip Outline (Top View)

Note: Package paddle (Pin 0) has to be RF grounded.

Table 11 Bill of Materials

Part Number	Part Type	Manufacturer	Size	Comment
L1 ... L3	Chip inductor	Various	0402	Wirewound, Q ≈ 50
C1 ... C7	Chip capacitor	Various	0402	

3.2 Pin Description

Table 12 Pin Definition and Function

Pin No.	Name	Function
0	GND	Ground connection for low band (800 MHz) LNA and control circuitry (package paddle)
1	n/c	Not connected
2	VGS	Gain step control
3	VCC	Supply voltage
4	RFGNDH	High band (2100 MHz) LNA emitter ground
5	n/c	Not connected
6	RFINM	Mid band (1900 MHz) LNA input
7	RFINH	High band (2100 MHz) LNA input
8	RFGNDM	Mid band (1900 MHz) LNA emitter ground
9	n/c	Not connected
10	RFINL	Low band (800 MHz) LNA input
11	VEN2	Band select control
12	VEN1	Band select control
13	n/c	Not connected
14	RFOUTL	Low band (800 MHz) LNA output
15	RFOUTH	High band (2100 MHz) LNA output
16	RFOUTM	Mid band (1900 MHz) LNA output

3.3 Application Board

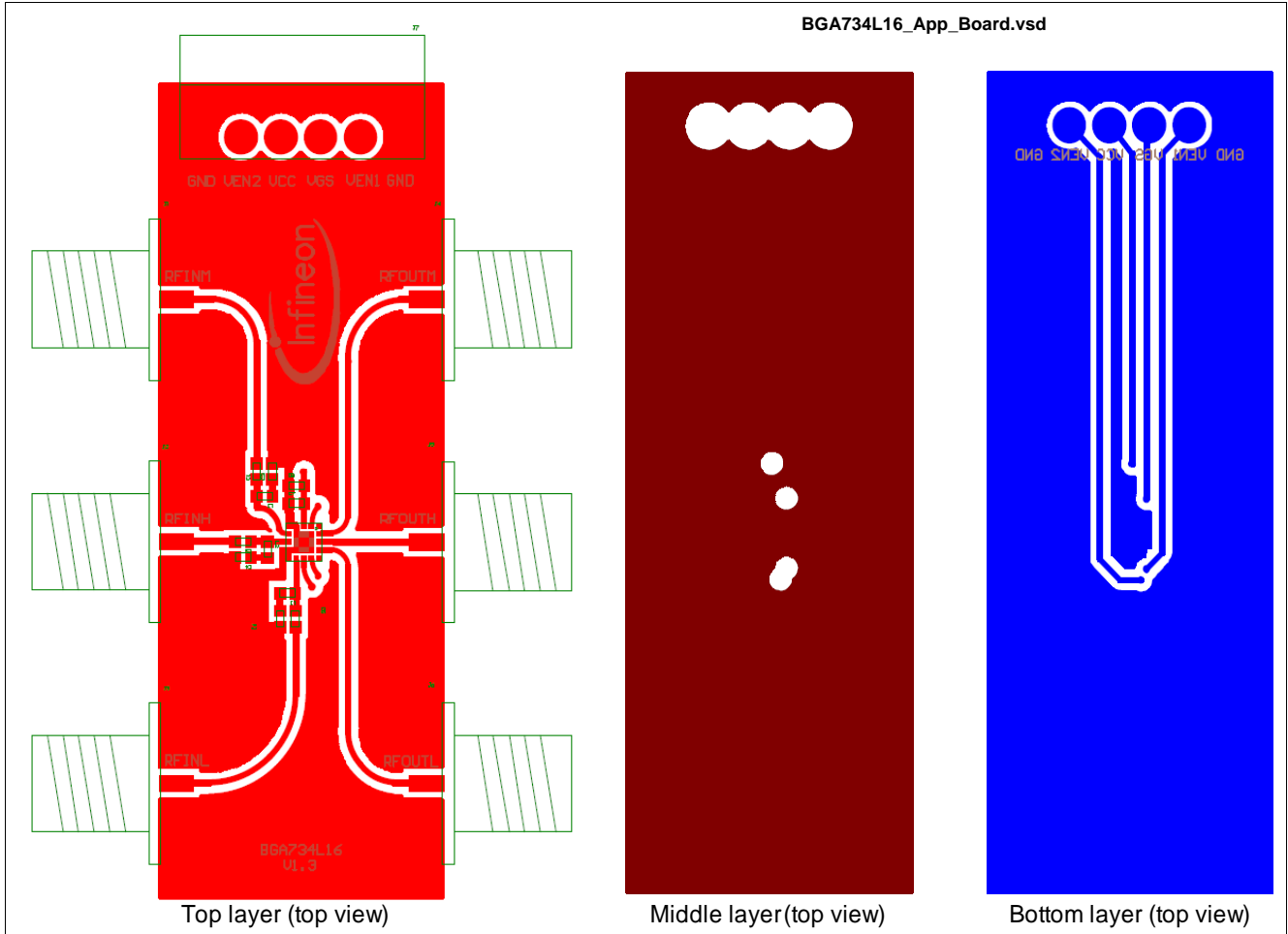

Figure 3 Application Board Layout on 3-layer FR4.

Note: Top layer thickness: 0.2 mm, bottom layer thickness: 0.8 mm, 17 μm Cu metallization, gold plated. Board size: 21 x 50 mm

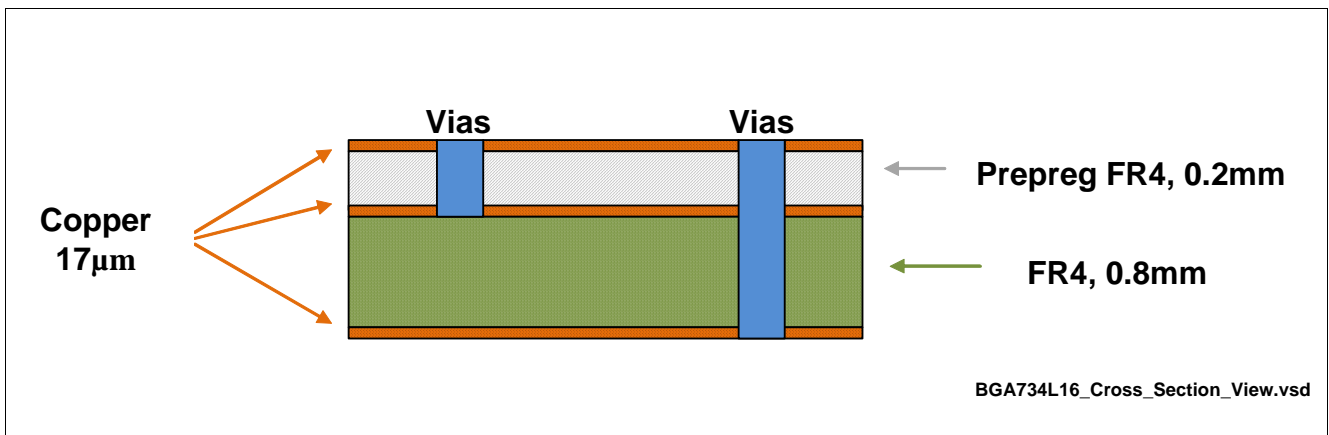

Figure 4 Cross-Section View of Application Board

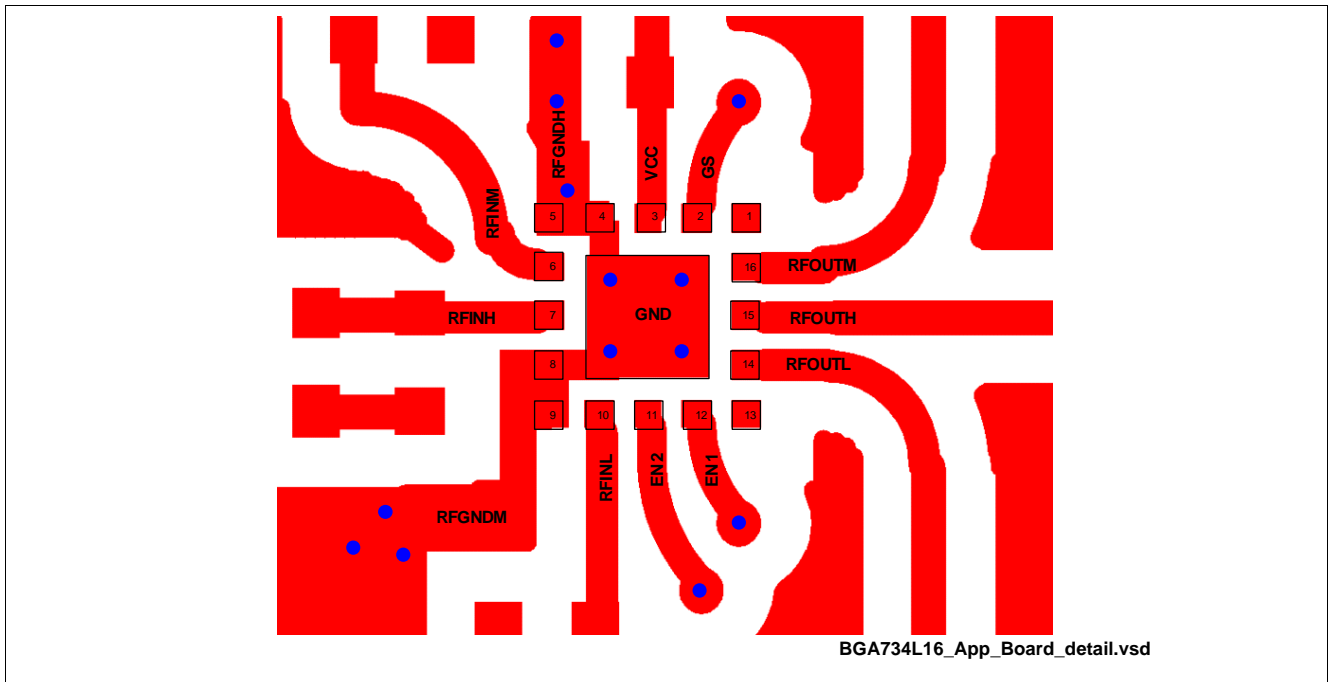

Figure 5 Detail of Application Board Layout

Note: In order to achieve the same performance as given in this datasheet please follow the suggested PCB-layout as closely as possible. The position of the GND vias is critical for RF performance.

4 Physical Characteristics

4.1 Package Footprint

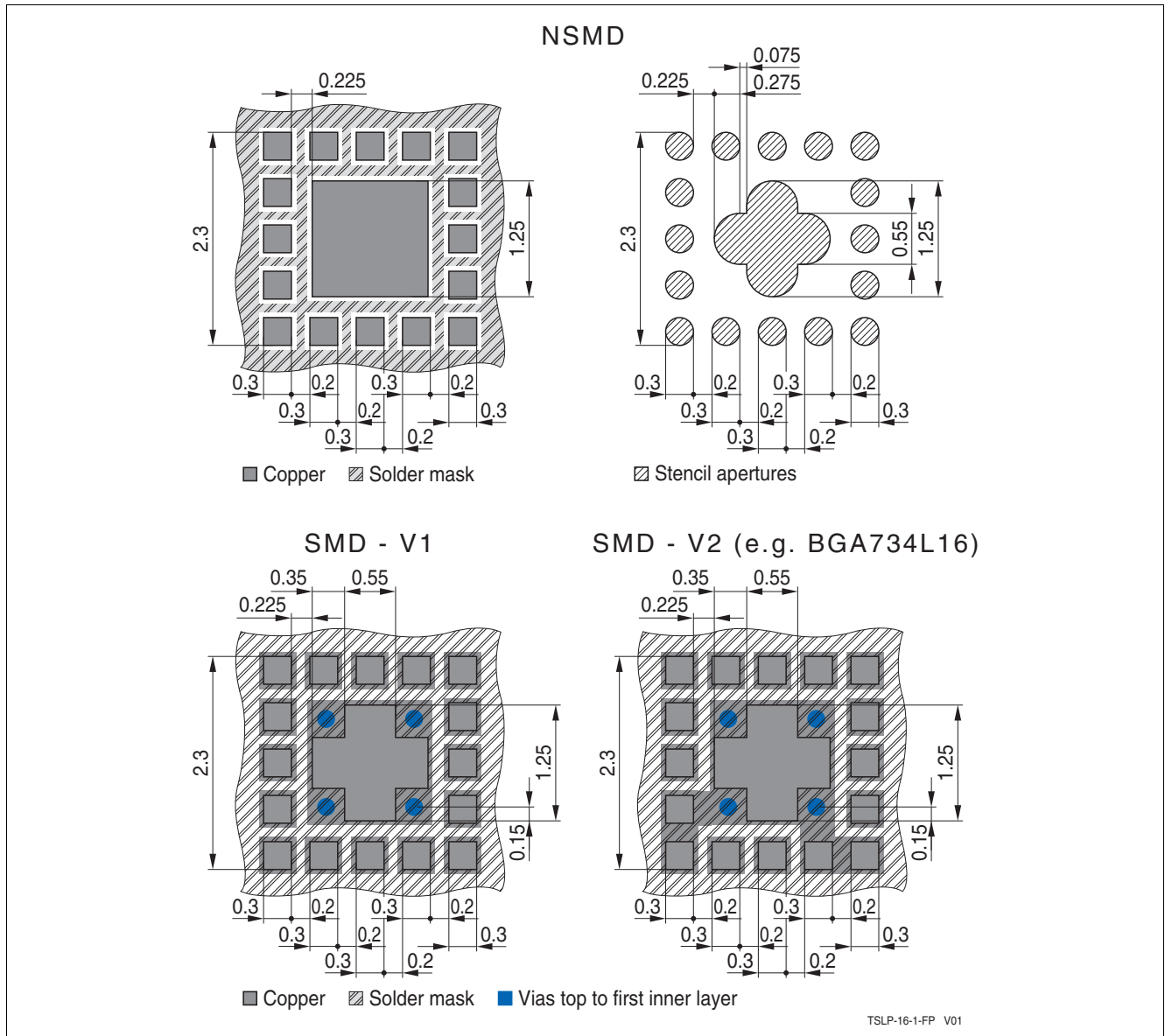

Figure 6 Recommended Footprint and Stencil Layout for the TSLP-16-1 Package

4.2 Package Dimensions

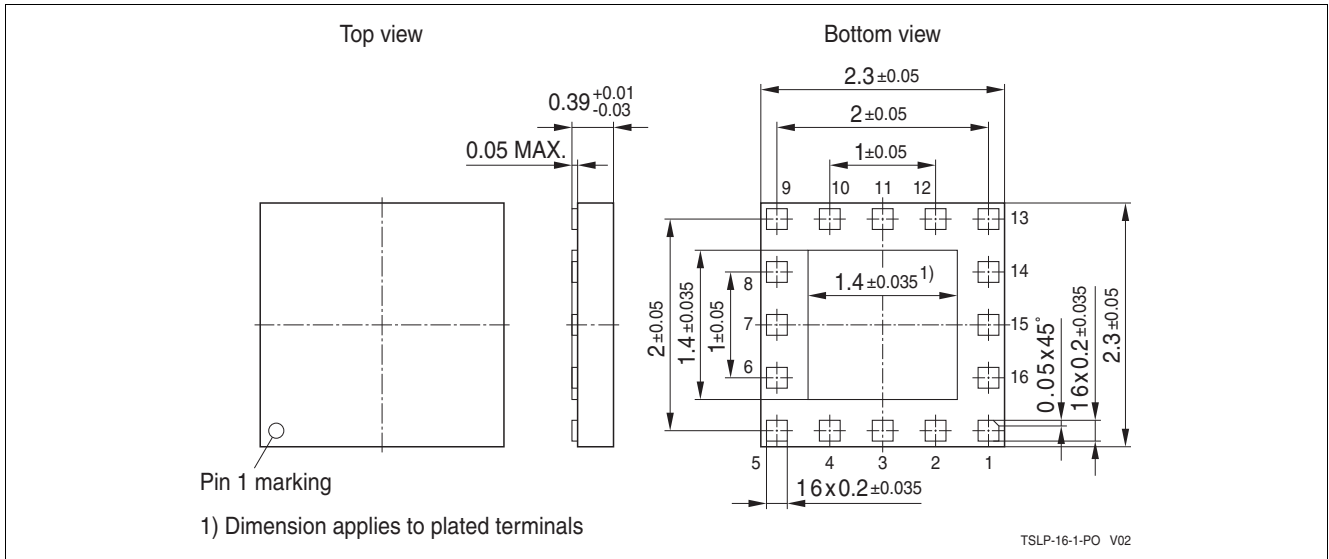

Figure 7 Package Outline (Top, Side and Bottom View)

www.infineon.com

Published by Infineon Technologies AG

Downloaded From [Oneyac.com](https://www.oneyac.com)

单击下面可查看定价，库存，交付和生命周期等信息

[>>Infineon\(英飞凌\)](#)