

Si4435DYPbF

HEXFET® Power MOSFET

- Ultra Low On-Resistance
- P-Channel MOSFET
- Surface Mount
- Available in Tape & Reel
- Lead-Free

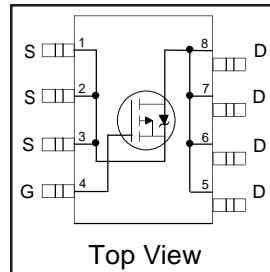

| |
|----------------------------|
| $V_{DSS} = -30V$ |
| $R_{DS(on)} = 0.020\Omega$ |

Description

These P-channel HEXFET® Power MOSFETs from International Rectifier utilize advanced processing techniques to achieve the extremely low on-resistance per silicon area. This benefit provides the designer with an extremely efficient device for use in battery and load management applications..

The SO-8 has been modified through a customized leadframe for enhanced thermal characteristics and multiple-die capability making it ideal in a variety of power applications. With these improvements, multiple devices can be used in an application with dramatically reduced board space. The package is designed for vapor phase, infrared, or wave soldering techniques.

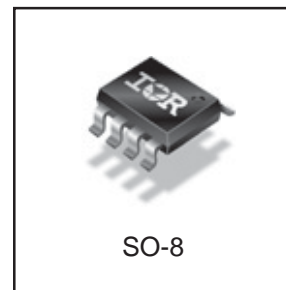

Absolute Maximum Ratings

| | Parameter | Max. | Units |
|--------------------------|---|--------------|-------|
| V_{DS} | Drain- Source Voltage | -30 | V |
| $I_D @ T_A = 25^\circ C$ | Continuous Drain Current, $V_{GS} @ -10V$ | -8.0 | A |
| $I_D @ T_A = 70^\circ C$ | Continuous Drain Current, $V_{GS} @ -10V$ | -6.4 | |
| I_{DM} | Pulsed Drain Current ① | -50 | |
| $P_D @ T_A = 25^\circ C$ | Power Dissipation | 2.5 | W |
| $P_D @ T_A = 70^\circ C$ | Power Dissipation | 1.6 | |
| | Linear Derating Factor | 0.02 | W/°C |
| V_{GS} | Gate-to-Source Voltage | ± 20 | V |
| T_J, T_{STG} | Junction and Storage Temperature Range | -55 to + 150 | °C |

Thermal Resistance

| | Parameter | Max. | Units |
|-----------------|------------------------------|------|-------|
| $R_{\theta JA}$ | Maximum Junction-to-Ambient③ | 50 | °C/W |

Electrical Characteristics @ T_J = 25°C (unless otherwise specified)

| | Parameter | Min. | Typ. | Max. | Units | Conditions |
|--|--------------------------------------|------|--------|-------|-------|---|
| V _{(BR)DSS} | Drain-to-Source Breakdown Voltage | -30 | — | — | V | V _{GS} = 0V, I _D = -250μA |
| ΔV _{(BR)DSS} /ΔT _J | Breakdown Voltage Temp. Coefficient | — | -0.019 | — | V/°C | Reference to 25°C, I _D = -1mA |
| R _{DS(on)} | Static Drain-to-Source On-Resistance | — | 0.015 | 0.020 | Ω | V _{GS} = -10V, I _D = -8.0A ② |
| | | — | 0.026 | 0.035 | | V _{GS} = -4.5V, I _D = -5.0A ② |
| V _{GS(th)} | Gate Threshold Voltage | -1.0 | — | — | V | V _{DS} = V _{GS} , I _D = -250μA |
| g _{fs} | Forward Transconductance | — | 11 | — | S | V _{DS} = -15V, I _D = -8.0A |
| I _{DSS} | Drain-to-Source Leakage Current | — | — | -10 | μA | V _{DS} = -24V, V _{GS} = 0V |
| | | — | — | -10 | | V _{DS} = -15V, V _{GS} = 0V, T _J = 70°C |
| I _{GSS} | Gate-to-Source Forward Leakage | — | — | -100 | nA | V _{GS} = -20V |
| | Gate-to-Source Reverse Leakage | — | — | 100 | | V _{GS} = 20V |
| Q _g | Total Gate Charge | — | 40 | 60 | nC | I _D = -4.6A |
| Q _{gs} | Gate-to-Source Charge | — | 7.1 | — | | V _{DS} = -15V |
| Q _{gd} | Gate-to-Drain ("Miller") Charge | — | 8.0 | — | | V _{GS} = -10V ② |
| t _{d(on)} | Turn-On Delay Time | — | 16 | 24 | ns | V _{DD} = -15V, V _{GS} = -10V ② |
| t _r | Rise Time | — | 76 | 110 | | I _D = -1.0A |
| t _{d(off)} | Turn-Off Delay Time | — | 130 | 200 | | R _G = 6.0Ω |
| t _f | Fall Time | — | 90 | 140 | | R _D = 15Ω |
| C _{iss} | Input Capacitance | — | 2320 | — | pF | V _{GS} = 0V |
| C _{oss} | Output Capacitance | — | 390 | — | | V _{DS} = -15V |
| C _{rss} | Reverse Transfer Capacitance | — | 270 | — | | f = 1.0kHz |

Source-Drain Ratings and Characteristics

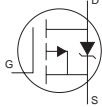
| | Parameter | Min. | Typ. | Max. | Units | Conditions |
|-----------------|--|------|------|------|-------|--|
| I _S | Continuous Source Current (Body Diode) | — | — | -2.5 | A | MOSFET symbol showing the integral reverse p-n junction diode.  |
| I _{SM} | Pulsed Source Current (Body Diode) ① | — | — | -50 | | |
| V _{SD} | Diode Forward Voltage | — | — | -1.2 | V | T _J = 25°C, I _S = -2.5A, V _{GS} = 0V ② |
| t _{rr} | Reverse Recovery Time | — | 34 | 51 | ns | T _J = 25°C, I _F = -2.5A |
| Q _{rr} | Reverse Recovery Charge | — | 33 | 50 | nC | di/dt = -100A/μs ② |

Notes:

- ① Repetitive rating; pulse width limited by max. junction temperature.
- ② Pulse width ≤ 300μs; duty cycle ≤ 2%.
- ③ Surface mounted on FR-4 board, t ≤ 5sec.

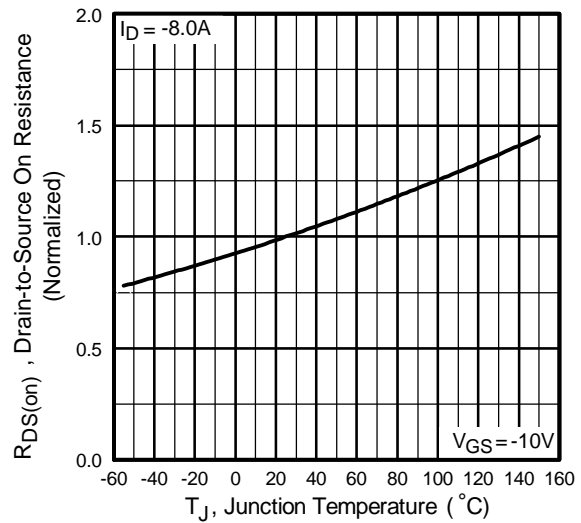
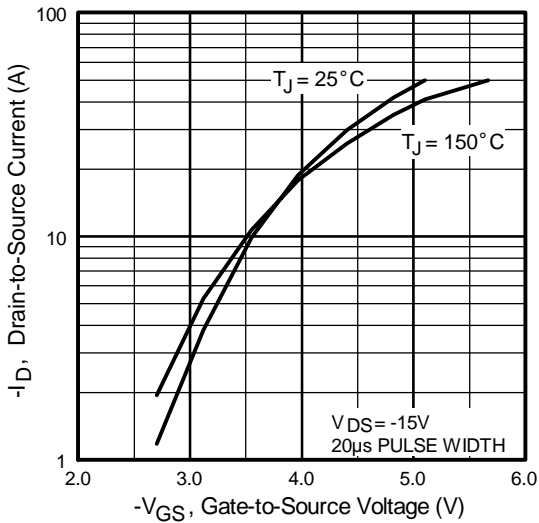
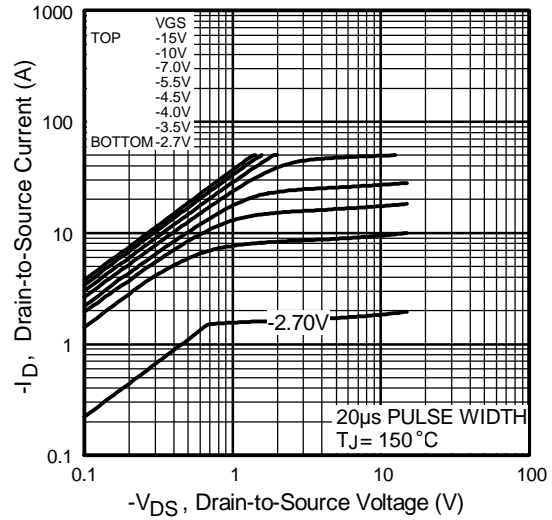
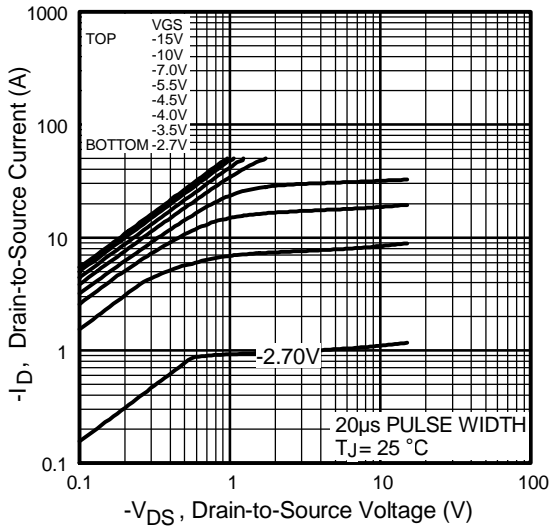

Si4435DYPbF

International
IR Rectifier

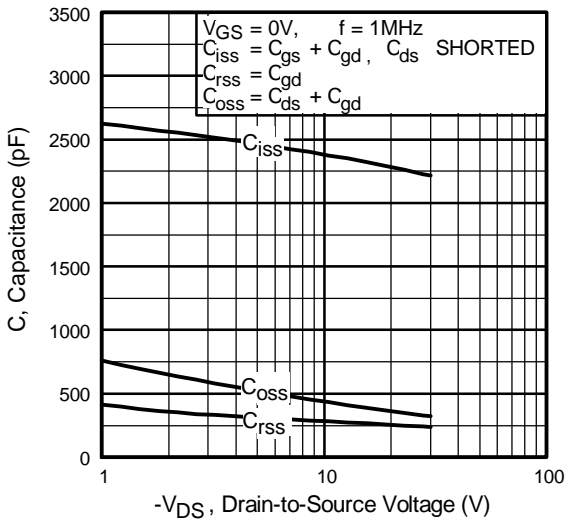

Fig 5. Typical Capacitance Vs. Drain-to-Source Voltage

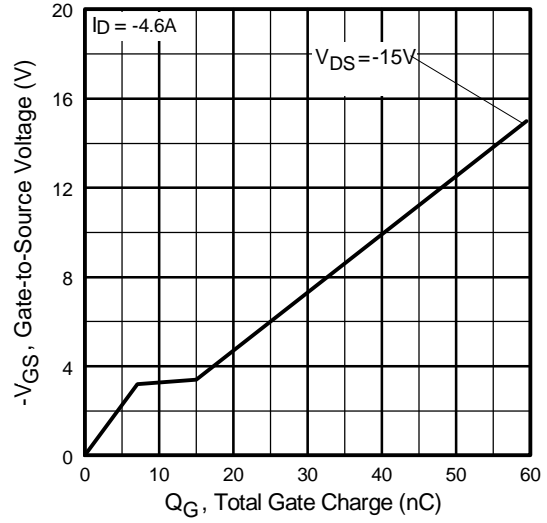

Fig 6. Typical Gate Charge Vs. Gate-to-Source Voltage

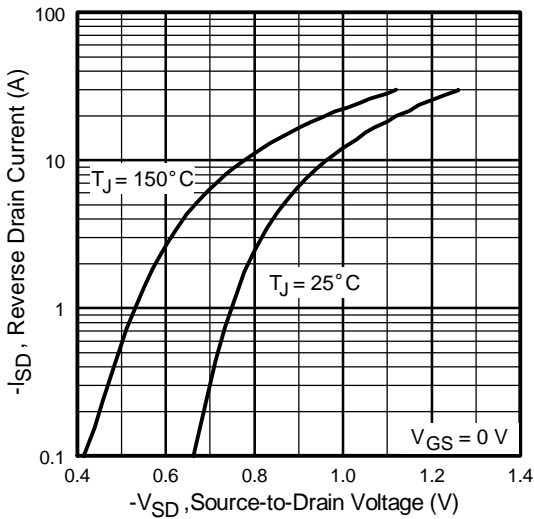

Fig 7. Typical Source-Drain Diode Forward Voltage

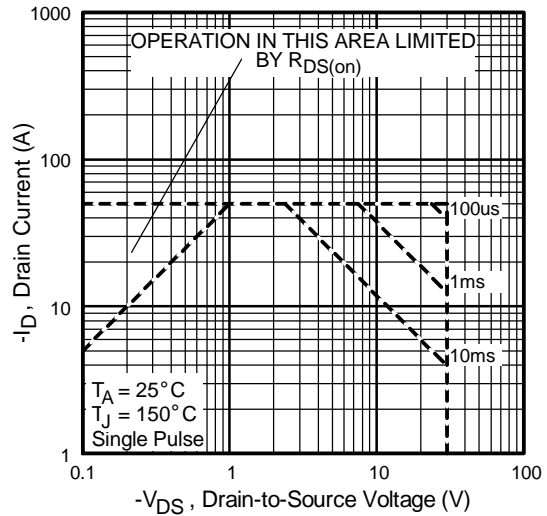

Fig 8. Maximum Safe Operating Area

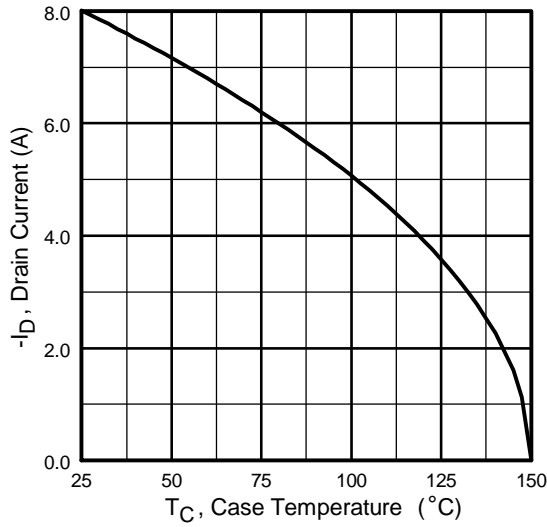

Fig 9. Maximum Drain Current Vs. Case Temperature

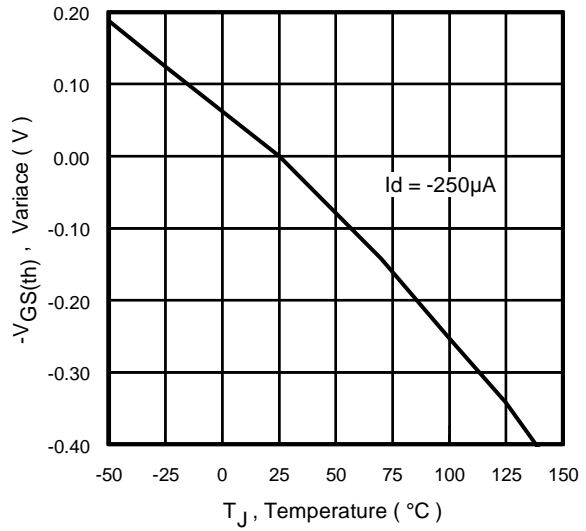

Fig 10. Typical V_{GS(th)} Variance Vs. Junction Temperature

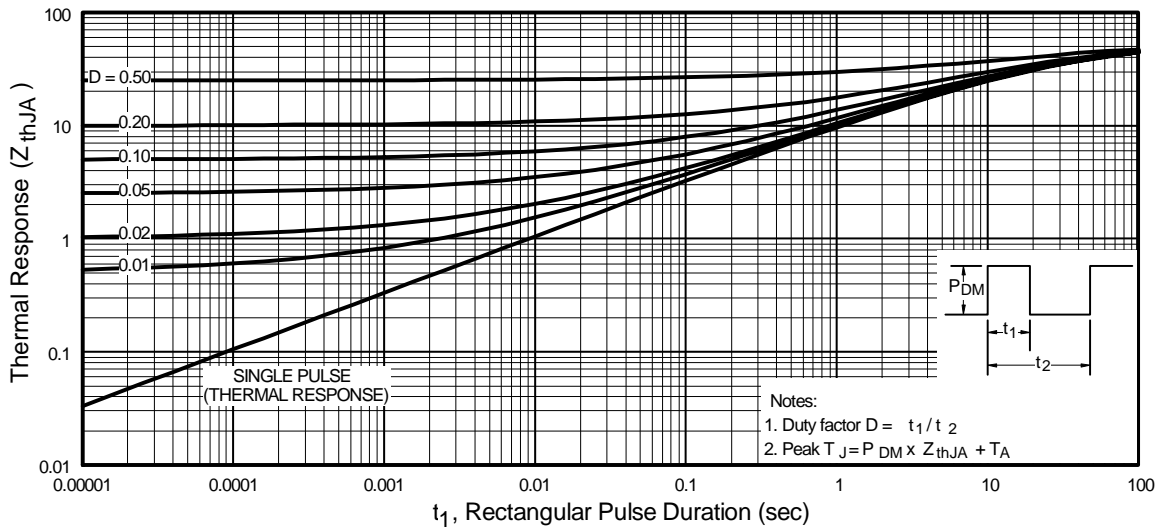

Fig 11. Maximum Effective Transient Thermal Impedance, Junction-to-Ambient

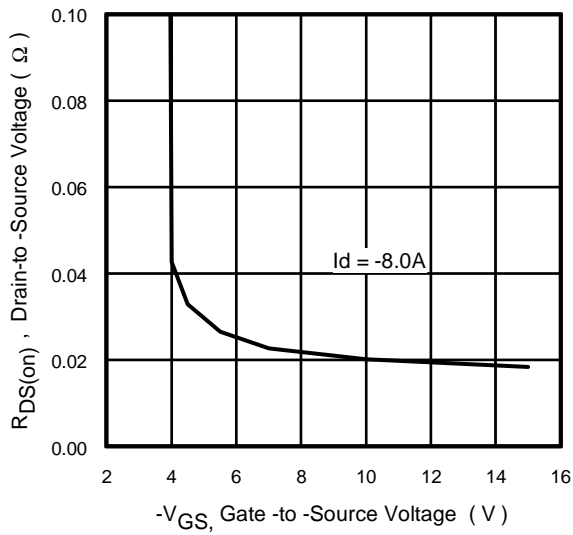

Fig 12. Typical On-Resistance Vs. Gate Voltage

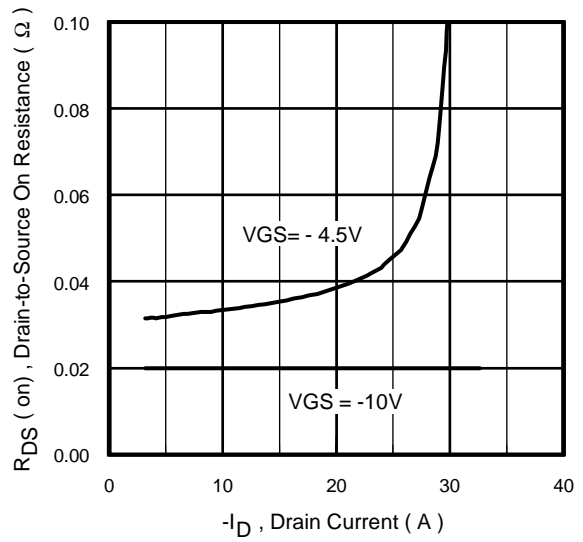
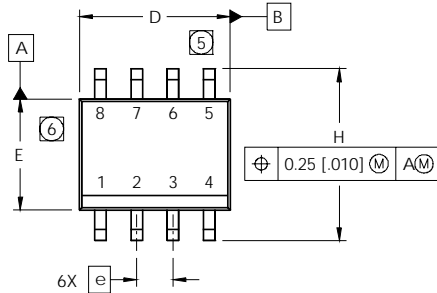

Fig 13. Typical On-Resistance Vs. Drain Current

SO-8 Package Outline

Dimensions are shown in millimeters (inches)



| DIM | INCHES | | MILLIMETERS | |
|-----|------------|-------|-------------|------|
| | MIN | MAX | MIN | MAX |
| A | .0532 | .0688 | 1.35 | 1.75 |
| A1 | .0040 | .0098 | 0.10 | 0.25 |
| b | .013 | .020 | 0.33 | 0.51 |
| c | .0075 | .0098 | 0.19 | 0.25 |
| D | .189 | .1968 | 4.80 | 5.00 |
| E | .1497 | .1574 | 3.80 | 4.00 |
| e | .050 BASIC | | 1.27 BASIC | |
| e1 | .025 BASIC | | 0.635 BASIC | |
| H | .2284 | .2440 | 5.80 | 6.20 |
| K | .0099 | .0196 | 0.25 | 0.50 |
| L | .016 | .050 | 0.40 | 1.27 |
| y | 0° | 8° | 0° | 8° |

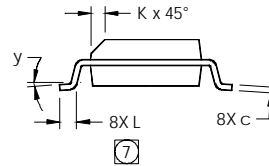
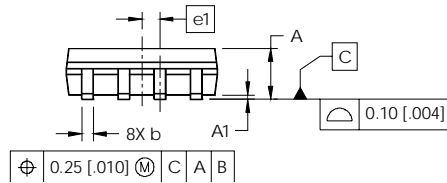

NOTES:

1. DIMENSIONING & TOLERANCING PER ASME Y14.5M-1994.
2. CONTROLLING DIMENSION: MILLIMETER
3. DIMENSIONS ARE SHOWN IN MILLIMETERS [INCHES].
4. OUTLINE CONFORMS TO JEDEC OUTLINE MS-012AA.
5. DIMENSION DOES NOT INCLUDE MOLD PROTRUSIONS. MOLD PROTRUSIONS NOT TO EXCEED 0.15 [0.006].
6. DIMENSION DOES NOT INCLUDE MOLD PROTRUSIONS. MOLD PROTRUSIONS NOT TO EXCEED 0.25 [0.010].
7. DIMENSION IS THE LENGTH OF LEAD FOR SOLDERING TO A SUBSTRATE.

FOOTPRINT

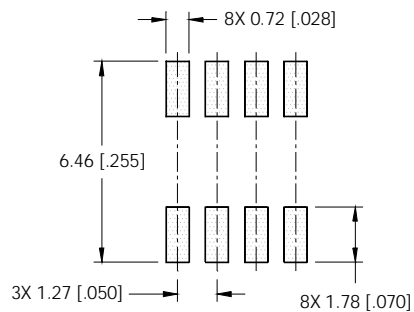

SO-8 Part Marking

EXAMPLE: THIS IS AN IRF7101 (MOSFET)

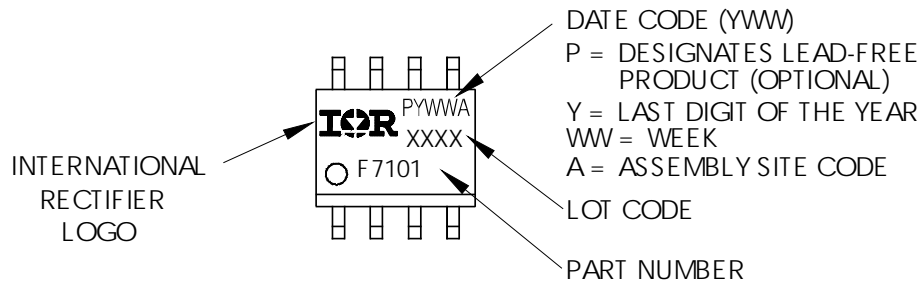

Si4435DYPbF

International
IR Rectifier

SO-8 Tape and Reel

Dimensions are shown in millimeters (inches)

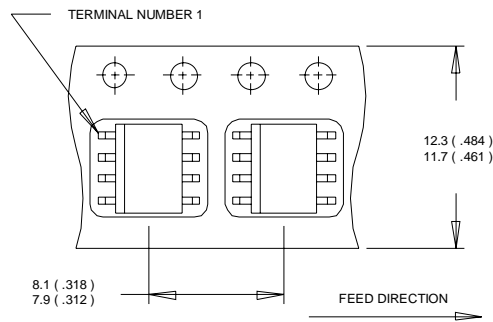

- NOTES:
1. CONTROLLING DIMENSION : MILLIMETER.
 2. ALL DIMENSIONS ARE SHOWN IN MILLIMETERS(INCHES).
 3. OUTLINE CONFORMS TO EIA-481 & EIA-541.

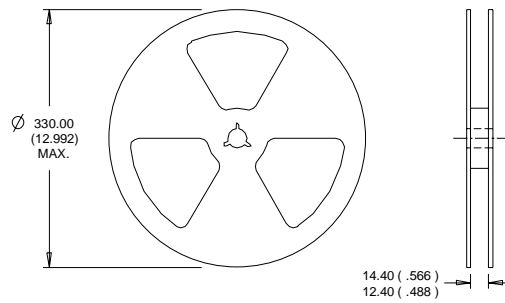

- NOTES:
1. CONTROLLING DIMENSION : MILLIMETER.
 2. OUTLINE CONFORMS TO EIA-481 & EIA-541.

Data and specifications subject to change without notice.
This product has been designed and qualified for the Consumer market.
Qualifications Standards can be found on IR's Web site.

International
IR Rectifier

IR WORLD HEADQUARTERS: 233 Kansas St., El Segundo, California 90245, USA Tel: (310) 252-7105
TAC Fax: (310) 252-7903

Visit us at www.irf.com for sales contact information.09/04

www.irf.com

单击下面可查看定价，库存，交付和生命周期等信息

[>>Infineon\(英飞凌\)](#)