

Pin	Symbol		Function
1	OUT	O	Output; output to the load; pin 1 and 5 must be externally shorted* .
2	IN	I	Input; activates the power switch if shorted to ground.
Tab/(3)	Vbb	+	Supply Voltage; positive power supply voltage; tab and pin3 are internally shorted.
4	IS	S	Sense Output; Diagnostic feedback; provides at normal operation a sense current proportional to the load current; in case of overload, overtemperature and/or short circuit a defined current is provided (see Truth Table on page 8)
5	OUT	O	Output; output to the load; pin 1 and 5 must be externally shorted* .

*) Not shorting all outputs will considerably increase the on-state resistance, reduce the peak current capability and decrease the current sense accuracy

Maximum Ratings at $T_j = 25\text{ °C}$ unless otherwise specified

Parameter	Symbol	Values	Unit
Supply voltage (overvoltage protection see page 4)	V_{bb}	38	V
Supply voltage for full short circuit protection ¹⁾	V_{bb}	30	V
Load dump protection $V_{LoadDump} = U_A + V_s$, $U_A = 13.5\text{ V}$ $R_I = 2\ \Omega$, $R_L = 1.5\ \Omega$, $t_d = 400\text{ ms}$, IN= low or high	$V_{Load\ dump}^{2)}$	45	V
Load current (Short-circuit current, see page 5)	I_L	self-limited	A
Operating temperature range	T_j	-40 ...+150	°C
Storage temperature range	T_{stg}	-55 ...+150	
Power dissipation (DC)	P_{tot}	59	W
Inductive load switch-off energy dissipation ³⁾	E_{AS}	0.3	J
single pulse $I_L = 20\text{ A}$, $V_{bb} = 12\text{ V}$ $T_j = 150\text{ °C}$:			
Electrostatic discharge capability (ESD) (Human Body Model) acc. ESD assn. std. S5.1-1993; R=1.5kΩ; C=100pF	V_{ESD}	3.0	kV
Current through input pin (DC)	I_{IN}	+15, -120	mA
Current through current sense pin (DC) see internal circuit diagrams page 9	I_{IS}	+15, -120	
Input voltage slew rate	dV_{bIN} / dt	self-limited 20	V/μs
	$V_{bb} \leq 16\text{ V}$: $V_{bb} > 16\text{ V}$ ⁴⁾ :		

1) Short circuit is defined as a combination of remaining resistances and inductances. See schematic on page 11.

2) $V_{Load\ dump}$ is setup without the DUT connected to the generator per ISO 7637-1 and DIN 40839.

3) See also diagram on page 11.

4) See also on page 8. Slew rate limitation can be achieved by means of using a series resistor R_{IN} in the input path. This resistor is also required for reverse operation. See also page 10.

Thermal Characteristics

Parameter and Conditions	Symbol	Values			Unit
		min	typ	max	
Thermal resistance chip - case: junction - ambient (free air): SMD version, device on PCB ⁶⁾	R_{thJC}	--	--	1.1	K/W
	R_{thJA}	--	80	--	
	R_{thJA}	--	45	55	

Electrical Characteristics

Parameter and Conditions at $T_j = 25$, $V_{bb} = 12$ V unless otherwise specified	Symbol	Values			Unit
		min	typ	max	

Load Switching Capabilities and Characteristics

On-state resistance (pin 3 to pin 1,5) $V_{IN} = 0$, $V_{bb} = 5.5$ V, $I_L = 7.5$ A $T_j = 25$ °C: $T_j = 150$ °C:	R_{ON}	--	10	14	mΩ
$V_{IN} = 0$, $V_{bb} = 12$ V, $I_L = 7.5$ A $T_j = 25$ °C: $T_j = 150$ °C:		--	8	10	
Output voltage drop limitation at small load currents (Tab to pin 1,5) ⁵⁾ $T_j = -40 \dots 150$ °C:	$V_{ON(NL)}$	--	30	65	mV
Nominal load current (Tab to pin 1,5) ISO Proposal: $V_{ON} \leq 0.5$ V, $T_C = 85$ °C, $T_j \leq 150$ °C SMD ⁶⁾ , $V_{ON} \leq 0.5$ V, $T_A = 85$ °C, $T_j \leq 150$ °C	$I_{L(ISO)}$ $I_{L(nom)}$	33 8	41 10	-- --	A
Turn-on time to 90% V_{OUT} :	t_{on}	--	250	500	μs
Turn-off time to 10% V_{OUT} : $R_L = 2.2$ Ω, $T_j = -40 \dots 150$ °C	t_{off}	--	250	500	
Slew rate on 25 to 50% V_{OUT} , $R_L = 2.2$ Ω, $T_j = -40 \dots 150$ °C	dV/dt_{on}	--	0.3	0.5	V/μs
Slew rate off 50 to 25% V_{OUT} , $R_L = 2.2$ Ω, $T_j = -40 \dots 150$ °C	$-dV/dt_{off}$	--	0.3	0.6	V/μs

⁵⁾ See figure 7a on page 15.

⁶⁾ Device on 50mm*50mm*1.5mm epoxy PCB FR4 with 6cm² (one layer, 70μm thick) copper area for V_{bb} connection. PCB is vertical without blown air.

Parameter and Conditions at $T_j = 25$, $V_{bb} = 12$ V unless otherwise specified	Symbol	Values			Unit
		min.	typ.	max.	

Operating Parameters

Operating voltage ($V_{IN}=0$)	$T_j = -40 \dots 150$ °C:	$V_{bb(on)}$	5.5	--	38	V
Undervoltage shutdown ^{7) 8)}		$V_{bIN(u)}$	--	2.5	3.5	V
Undervoltage restart of charge pump		$V_{bb(ucp)}$	--	4	5.5	V
Overvoltage protection ⁹⁾		$V_{Z,IN}$	63	67	--	V
$I_{bb} = 15$ mA	$T_j = -40 \dots +150$ °C:					
Standby current	$T_j = -40 \dots +120$ °C:	$I_{bb(off)}$	--	3	6	μA
$I_{IN} = 0$	$T_j = 150$ °C:		--	6	14	

Reverse Battery

Reverse battery voltage ¹⁰⁾		$-V_{bb}$	--	--	16	V
On-state resistance (pin 1,5 to pin 3)						
$V_{bb} = -8$ V, $V_{IN} = 0$, $I_L = -7.5$ A, $R_{IS} = 1$ kΩ, ⁸⁾						
	$T_j = 25$ °C:	$R_{ON(inv)}$	--	9.5	13	mΩ
	$T_j = 150$ °C:		--	16	22	
$V_{bb} = -12$ V, $V_{IN} = 0$, $I_L = -7.5$ A, $R_{IS} = 1$ kΩ, $T_j = 25$ °C:			--	9	12	
	$T_j = 150$ °C:		--	15	20	
Integrated resistor in V_{bb} line		R_{bb}	--	100	150	Ω

Inverse Operation ¹¹⁾

Output voltage drop (pin 1,5 to pin 3) ⁸⁾						
$I_L = -7.5$ A, $R_{IS} = 1$ kΩ,	$T_j = 25$ °C:	$-V_{ON(inv)}$	--	700	--	mV
$I_L = -7.5$ A, $R_{IS} = 1$ kΩ,	$T_j = 150$ °C:		--	300	--	
Turn-on delay after inverse operation; $I_L > 0$ A ⁸⁾						
$V_{IN(inv)} = V_{IN(fwd)} = 0$ V		$t_{d(inv)}$	--	1	--	ms

⁷⁾ $V_{bIN} = V_{bb} - V_{IN}$ see schematic on page 8 and page 14.

⁸⁾ Not subject to production test, specified by design.

⁹⁾ See also $V_{Z(IN)}$ in schematic page 9.

¹⁰⁾ For operation at voltages higher than 16V please see required schematic on page 10.

¹¹⁾ Permanent Inverse operation results eventually in a current flow via the intrinsic diode of the power DMOS. In this case the device switches on with a time delay $t_{d(inv)}$ after the transition from inverse to forward mode.

Parameter and Conditions at $T_j = 25$, $V_{bb} = 12$ V unless otherwise specified	Symbol	Values			Unit	
		min.	typ.	max.		
Protection Functions ¹²⁾						
Short circuit current limit (Tab to pin 1,5) ¹³⁾						
Short circuit current limit at $V_{ON} = 6V$ ¹⁴⁾	$T_j = -40^\circ C:$ $T_j = 25^\circ C:$ $T_j = +150^\circ C:$	$I_{L6(SC)}$	-- -- 70	110 105 90	140 -- --	A
Short circuit current limit at $V_{ON} = 12V$ $t_m = 170\mu s$	$T_{j(start)} = -40^\circ C:$ $T_{j(start)} = 25^\circ C:$ $T_{j(start)} = +150^\circ C:$	$I_{L12(SC)}$	-- -- 45	80 75 60	110 -- --	A
Short circuit current limit at $V_{ON} = 18V$ ¹⁴⁾	$T_{j(start)} = -40^\circ C:$ $T_{j(start)} = 25^\circ C:$ $T_{j(start)} = +150^\circ C:$	$I_{L18(SC)}$	-- -- 33	60 55 50	80 -- --	A
Short circuit current limit at $V_{ON} = 24V$ $t_m = 170\mu s$	$T_{j(start)} = -40^\circ C:$ $T_{j(start)} = 25^\circ C:$ $T_{j(start)} = +150^\circ C:$	$I_{L24(SC)}$	-- -- 20	40 40 35	60 -- --	A
Short circuit current limit at $V_{ON} = 30V$ ¹⁴⁾	$T_{j(start)} = -40^\circ C:$ $T_{j(start)} = 25^\circ C:$ $T_{j(start)} = +150^\circ C:$	$I_{L30(SC)}$	-- -- 15	25 25 25	40 -- --	A
Short circuit shutdown detection voltage (pin 3 to pins 1,5)		$V_{ON(SC)}$	2.5	3.5	4.5	V
Short circuit shutdown delay after input current positive slope, $V_{ON} > V_{ON(SC)}$, $T_j = -40...+150^\circ C$ min. value valid only if input "off-signal" time exceeds 30 μs		$t_d(SC1)$	350	650	1200	μs
Short circuit shutdown delay during on condition ¹⁴⁾ $V_{ON} > V_{ON(SC)}$		$t_d(SC2)$	--	2	--	μs
Output clamp (inductive load switch off) ¹⁵⁾ at $V_{OUT} = V_{bb} - V_{ON(CL)}$ (e.g. overvoltage) $I_L = 40$ mA		$V_{ON(CL)}$	39	42	--	V
Thermal overload trip temperature		T_{jt}	150	175	--	$^\circ C$
Thermal hysteresis		ΔT_{jt}	--	10	--	K

¹²⁾ Integrated protection functions are designed to prevent IC destruction under fault conditions described in the data sheet. Fault conditions are considered as "outside" normal operating range. Protection functions are not designed for continuous repetitive operation.

¹³⁾ Short circuit current limit for max. duration of $t_d(SC1)$, prior to shutdown, see also figures 3.x on page 13.

¹⁴⁾ Not subject to production test, specified by design.

¹⁵⁾ See also figure 2b on page 12.

Parameter and Conditions at $T_j = 25$, $V_{bb} = 12$ V unless otherwise specified	Symbol	Values			Unit
		min.	typ.	max.	
Diagnostic Characteristics					
Current sense ratio, static on-condition $k_{ILIS} = I_L : I_{IS}$, $I_{IS} < I_{IS,lim}$ ¹⁶⁾ , $V_{IS} < V_{OUT} - 5$ V, $V_{bIN} > 4.5$ V	k_{ILIS}	--	10 000	--	
IL = 30A, $T_j = -40^\circ\text{C}$:		8300	10000	11000	
T _j = +25°C:		8300	9700	10600	
T _j = +150°C:		8300	9300	10000	
IL = 7.5A, $T_j = -40^\circ\text{C}$:		7500	10000	11400	
T _j = +25°C:		8000	9700	10800	
T _j = +150°C:		8200	9300	10200	
IL = 2.5A, $T_j = -40^\circ\text{C}$:		7100	10000	13400	
T _j = +25°C:		7700	9700	12500	
T _j = +150°C:		8000	9300	12000	
IL = 0.5A, $T_j = -40^\circ\text{C}$:	5000	12000	21000		
T _j = +25°C:	5500	12000	19000		
T _j = +150°C:	6000	12000	18000		
$I_{IN} = 0$ (e.g. during deenergizing of inductive loads):		--	0	--	
Sense current under fault conditions ¹⁷⁾ $V_{ON} > 1$ V, typ $T_j = -40\dots+150^\circ\text{C}$:	$I_{IS,fault}$	4.0	5.2	7.5	mA
Sense saturation current $V_{ON} < 1$ V, typ $T_j = -40\dots+150^\circ\text{C}$:	$I_{IS,lim}$	4.0	6.0	7.5	mA
Fault-Sense signal delay after input current positive slope, $V_{ON} > 1$ V, $T_j = -40\dots+150^\circ\text{C}$	$t_{delay(fault)}$	350	650	1200	μs
Current sense leakage current, $I_{IN} = 0$	$I_{IS(LL)}$	--	0.1	0.5	μA
Current sense offset current, $V_{IN} = 0$, $I_L \leq 0$	$I_{IS(LH)}$	--	0.1	1	μA
Minimum load current for sense functionality, $V_{IN} = 0$, $T_j = -40\dots+150^\circ\text{C}$	$I_{L(MIN)}$	50	--	--	mA
Current sense settling time to I_{IS} static after input current positive slope, ¹⁸⁾ $I_L = 0$ \square 20 A, $T_j = -40\dots+150^\circ\text{C}$	$t_{son(IS)}$	--	250	500	μs
Current sense settling time during on condition, ¹⁸⁾ $I_L = 10$ \square 20 A, $T_j = -40\dots+150^\circ\text{C}$	$t_{slc(IS)}$	--	50	100	μs
Overvoltage protection $I_{bb} = 15$ mA $T_j = -40\dots+150^\circ\text{C}$:	$V_{Z,IS}$	63	67	--	V

¹⁶⁾ See also figures 4.x and 6.x on page 13 and 14.

¹⁷⁾ Fault conditions are overload during on (i.e. $V_{ON} > 1$ V typ.), overtemperature and short circuit; see also truth table on page 8.

¹⁸⁾ Not subject to production test, specified by design.

Parameter and Conditions at $T_j = 25$, $V_{bb} = 12$ V unless otherwise specified	Symbol	Values			Unit
		min.	typ.	max.	
Input					
Required current capability of input switch $T_j = -40..+150^\circ\text{C}$:	$I_{IN(on)}$	--	1.4	2.2	mA
Input current for turn-off $T_j = -40..+150^\circ\text{C}$:	$I_{IN(off)}$	--	--	30	μA

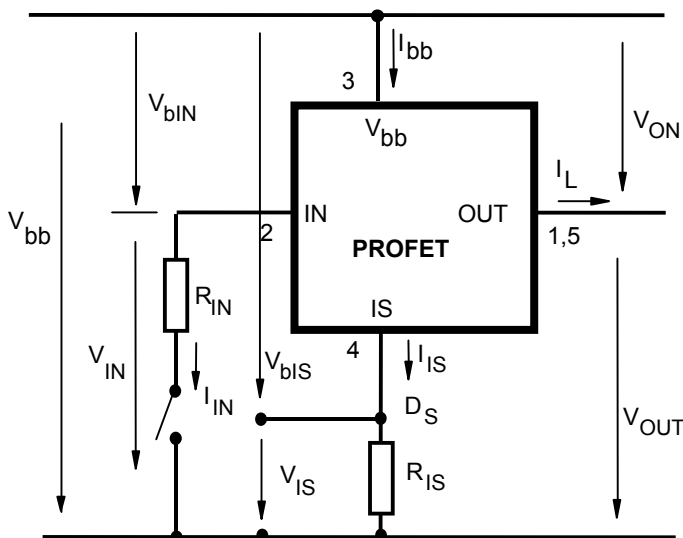
Truth Table

	Input Current level	Output level	Current Sense I_{IS}
Normal operation	L H	L H	≈ 0 ($I_{IS(LL)}$) nominal
Overload ¹⁹⁾	L H	L H	≈ 0 ($I_{IS(LL)}$) $I_{IS, fault}$
Short circuit to GND ²⁰⁾	L H	L L	≈ 0 ($I_{IS(LL)}$) $I_{IS, fault}$
Overtemperature	L H	L L	≈ 0 ($I_{IS(LL)}$) $I_{IS, fault}$
Short circuit to V_{bb}	L H	H H	≈ 0 ($I_{IS(LL)}$) < nominal ²¹⁾
Open load	L H	Z H	≈ 0 ($I_{IS(LL)}$) ≈ 0 ($I_{IS(LH)}$)

L = "Low" Level
H = "High" Level

Z = high impedance, potential depends on external circuit

Terms

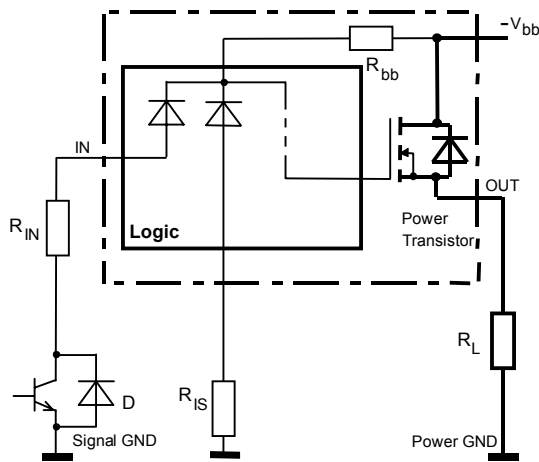


Two or more devices can easily be connected in parallel to increase load current capability.

¹⁹⁾ Overload is detected at the following condition: $1V$ (typ.) < V_{ON} < $3.5V$ (typ.) . See also page 11.

²⁰⁾ Short Circuit is detected at the following condition: $V_{ON} > 3.5V$ (typ.) . See also page 11.

²¹⁾ Low ohmic short to V_{bb} may reduce the output current I_L and therefore also the sense current I_{IS} .

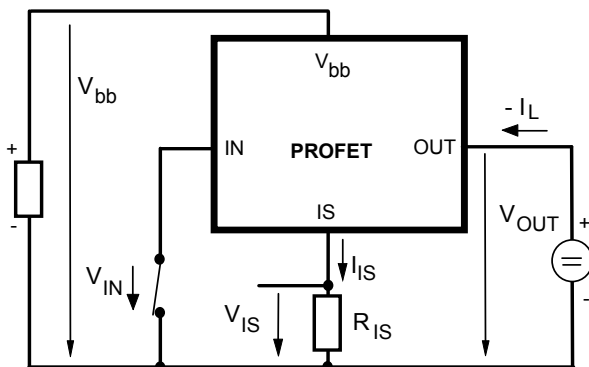
Reversave™ (Reverse battery protection)


R_{IS} typ. 1 k Ω . Add R_{IN} for reverse battery protection in applications with V_{bb} above 16V;

$$\text{recommended value: } \frac{1}{R_{IN}} + \frac{1}{R_{IS}} = \frac{0.08A}{|V_{bb}|-12V}$$

To minimise power dissipation at reverse battery operation, the overall current into the IN and IS pin should be about 80mA. The current can be provided by using a small signal diode D in parallel to the input switch, by using a MOSFET input switch or by proper adjusting the current through R_{IS} .

Since the current via R_{bb} generates additional heat in the device, this has to be taken into account in the overall thermal consideration.

Inverse load current operation


The device can be operated in inverse load current mode ($V_{OUT} > V_{bb} > 0V$). The current sense feature is not available during this kind of operation ($I_{IS} = 0$). In case of inverse operation the intrinsic drain source diode is eventually conducting resulting in considerably increased power dissipation.

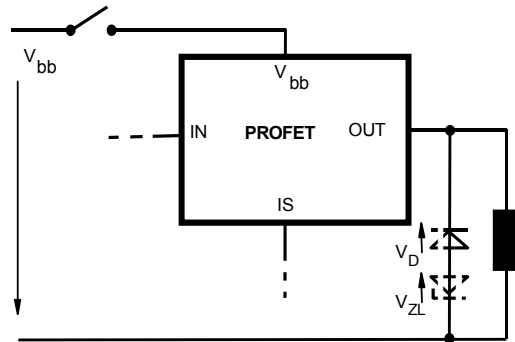
The transition from inverse to forward mode can result in a delayed switch on.

Note: Temperature protection during inverse load current operation is not possible!

 V_{bb} disconnect with energised inductive load

Provide a current path with load current capability by using a diode, a Z-diode, or a varistor. ($V_{ZL} + V_D < 39V$ if $R_{IN} = 0$). For higher clamp voltages currents at IN and IS have to be limited to 120 mA.

Version a:

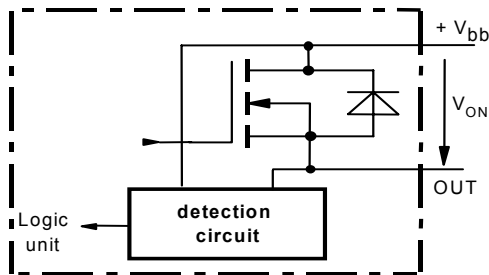


Short circuit detection

Fault Condition: $V_{ON} > V_{ON(SC)}$ (3.5V typ.) and $t > t_{d(SC)}$ (typ.650 μ s).

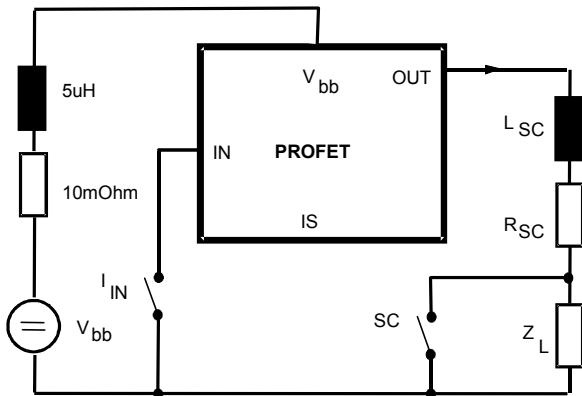
Overload detection

Fault Condition: $V_{ON} > 1$ V typ.

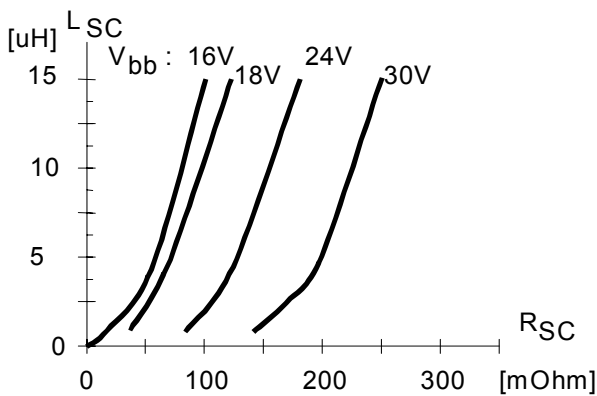


Short circuit

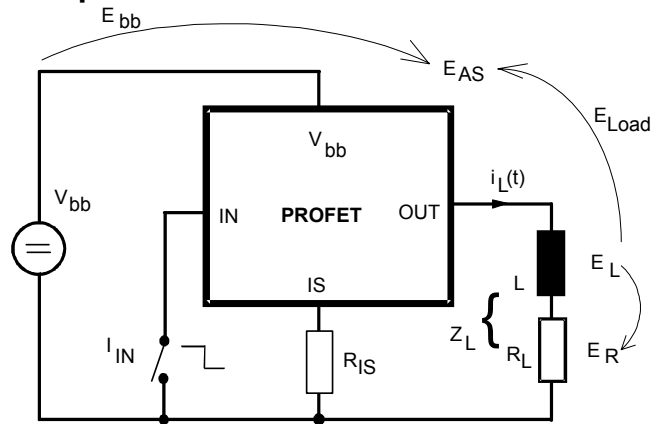
Short circuit is a combination of primary and secondary impedance's and a resistance's.



Allowable combinations of minimum, secondary resistance for full protection at given secondary inductance and supply voltage for single short circuit event;



Inductive load switch-off energy dissipation



Energy stored in load inductance:

$$E_L = 1/2 \cdot L \cdot I_L^2$$

While demagnetizing load inductance, the energy dissipated in PROFET is

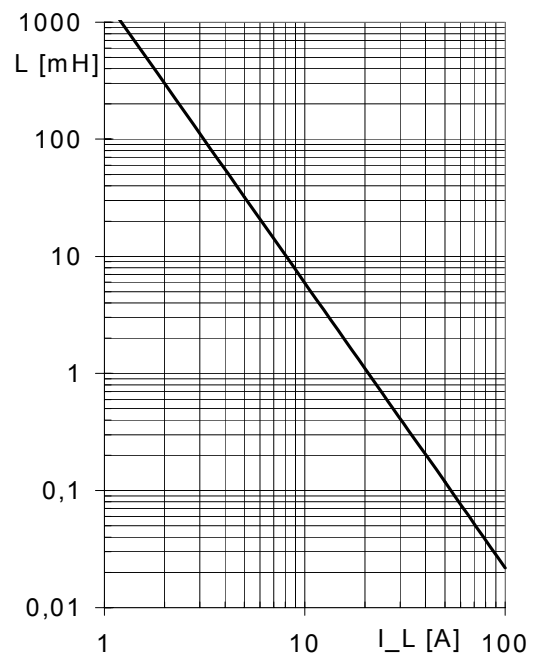
$$E_{AS} = E_{bb} + E_L - E_R = \int V_{ON(CL)} \cdot i_L(t) dt,$$

with an approximate solution for $R_L > 0 \Omega$:

$$E_{AS} = \frac{I_L \cdot L}{2 \cdot R_L} (V_{bb} + |V_{OUT(CL)}|) \ln \left(1 + \frac{I_L \cdot R_L}{|V_{OUT(CL)}|} \right)$$

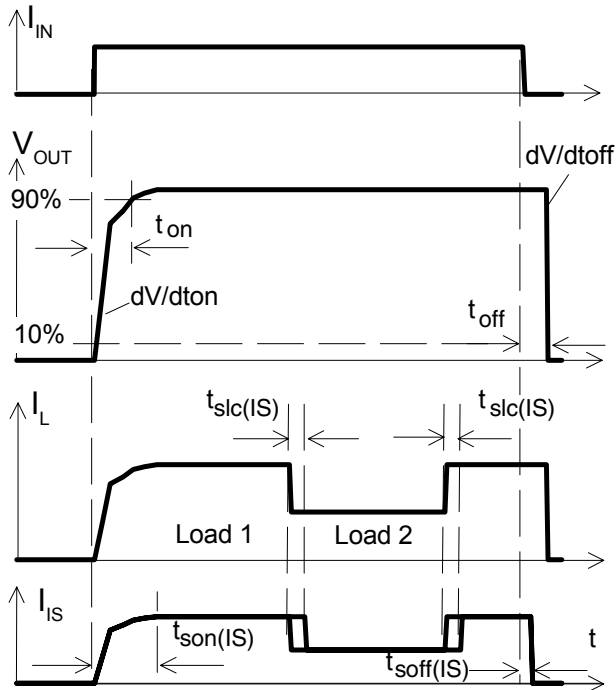
Maximum allowable load inductance for a single switch off

$L = f(I_L)$; $T_{j,start} = 150^\circ C$, $V_{bb} = 12$ V, $R_L = 0 \Omega$



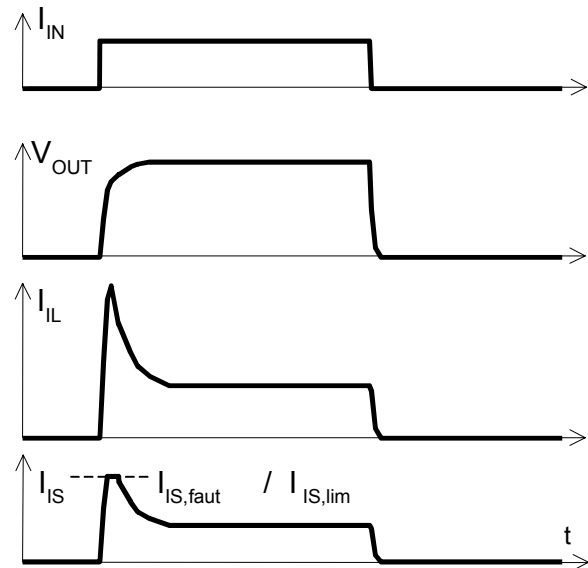
Timing diagrams

Figure 1a: Switching a resistive load, change of load current in on-condition:



The sense signal is not valid during a settling time after turn-on/off and after change of load current.

Figure 2a: Switching motors and lamps:



As long as $V_{bIS} < V_{Z,IS}$ the sense current will never exceed $I_{IS,fault}$ and/or $I_{IS,lim}$.

Figure 2b: Switching an inductive load:

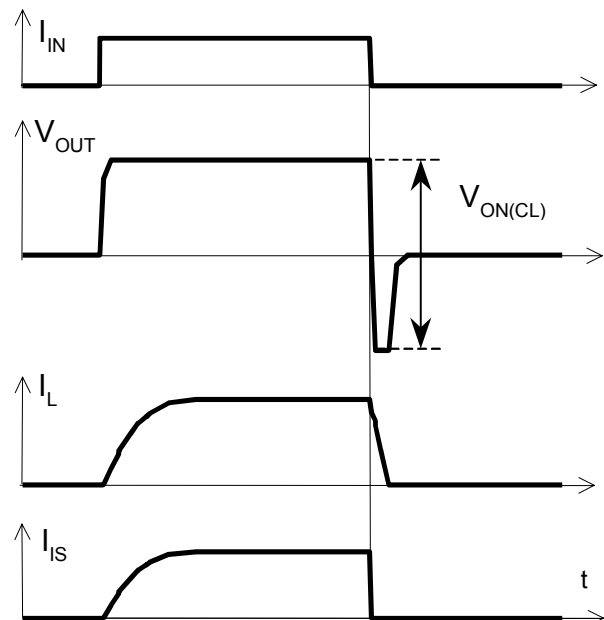
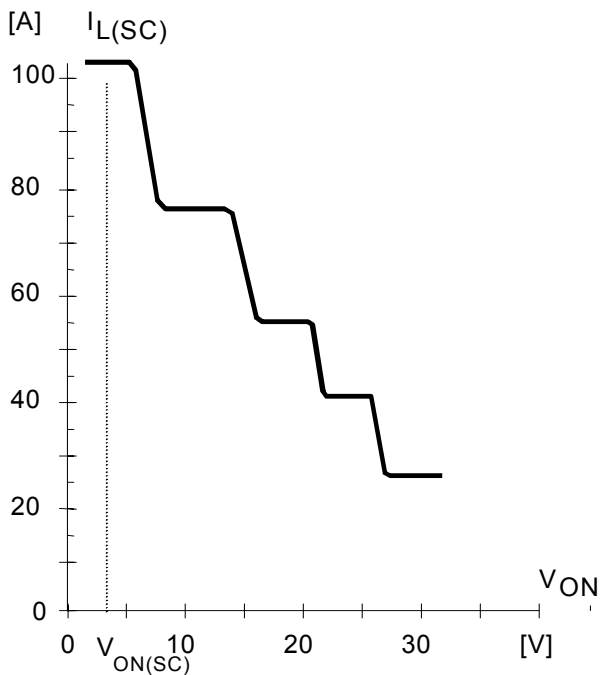
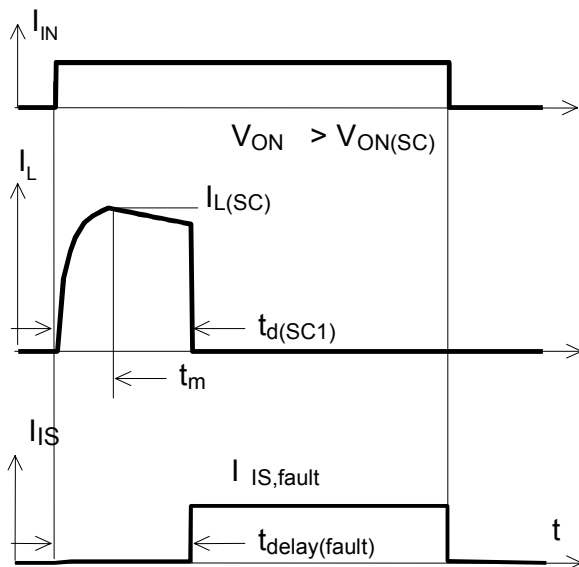
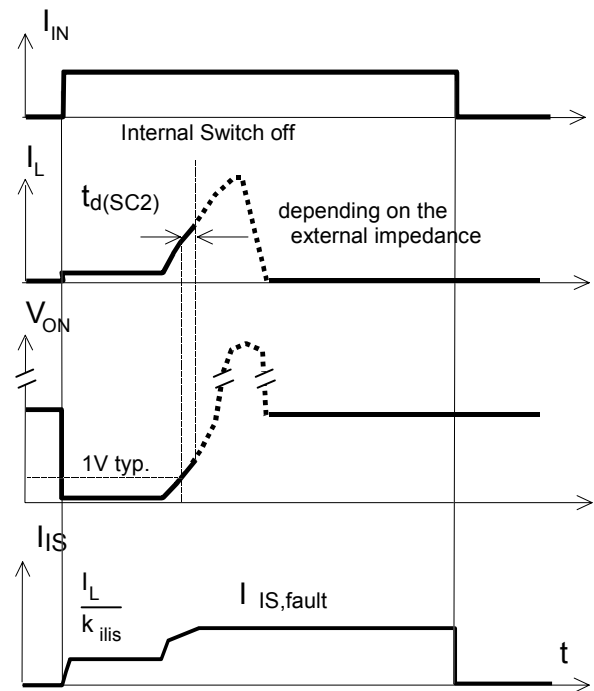


Figure 3a: Typ. current limitation characteristic


In case of $V_{ON} > V_{ON(SC)}$ (typ. 4 V) the device will be switched off by internal short circuit detection.

Figure 3b: Short circuit type one: shut down by short circuit detection, reset by $I_{IN} = 0$.


Shut down remains latched until next reset via input.

Figure 3c: Short circuit type two: shut down by short circuit detection, reset by $I_{IN} = 0$.


Shut down remains latched until next reset via input.

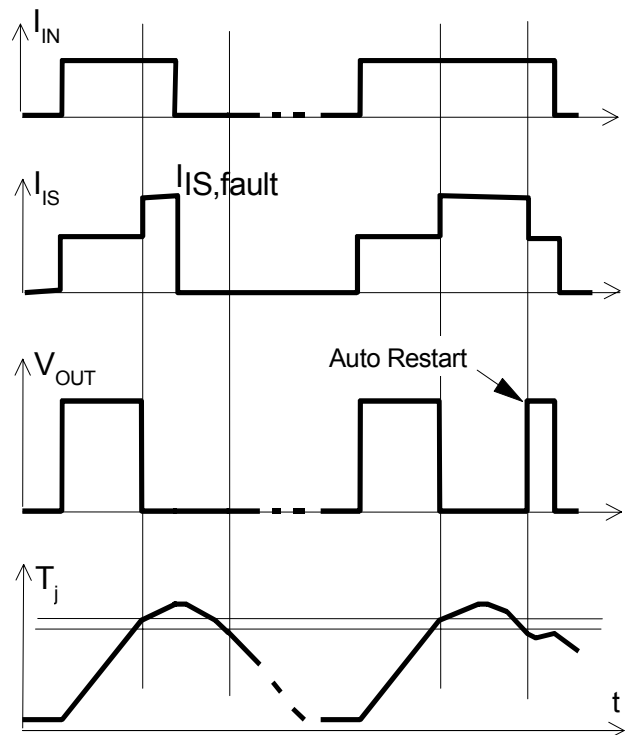
Figure 4a: Overtemperature Reset if $T_j < T_{jt}$


Figure 4b: Overload

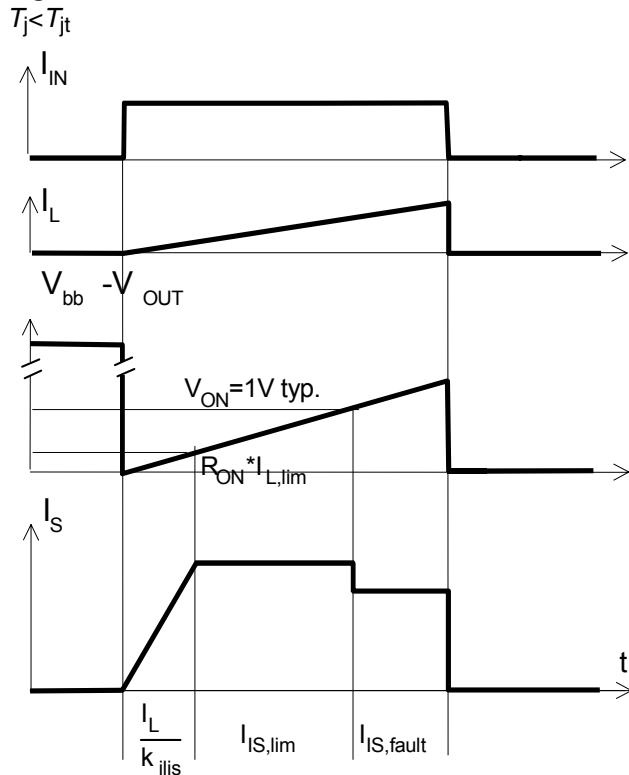


Figure 5a: Undervoltage restart of charge pump, overvoltage clamp

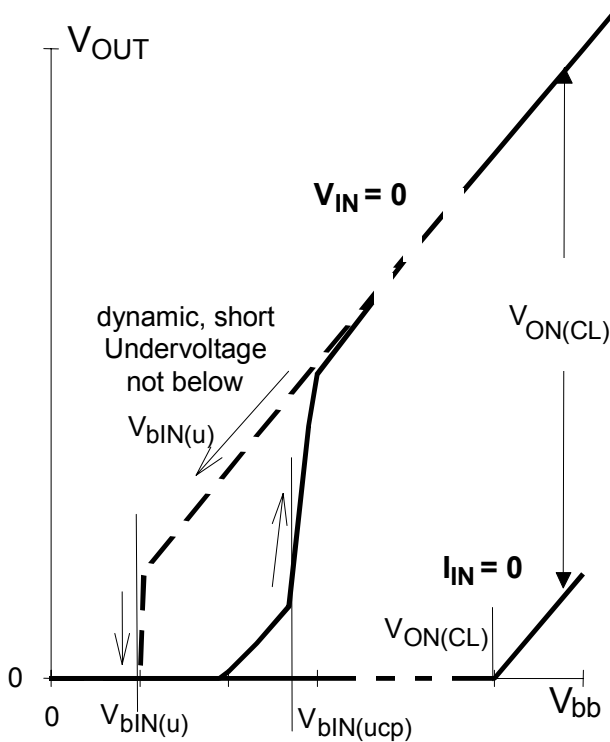


Figure 6a: Current sense versus load current:

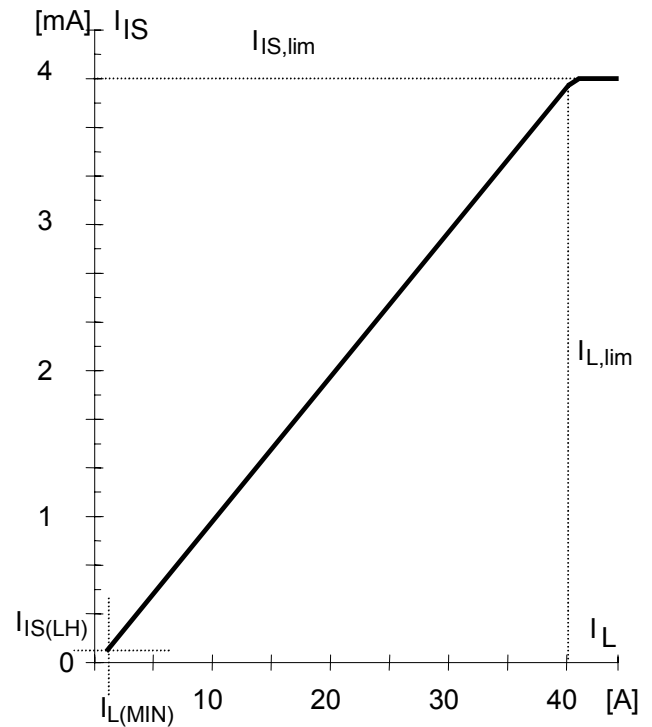
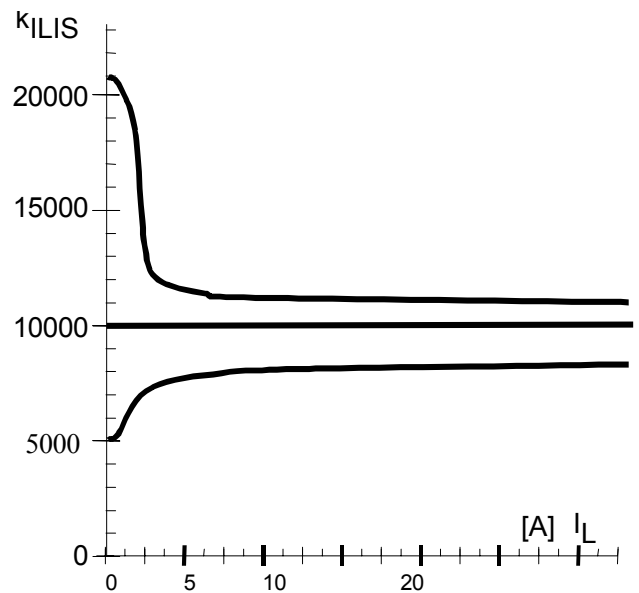
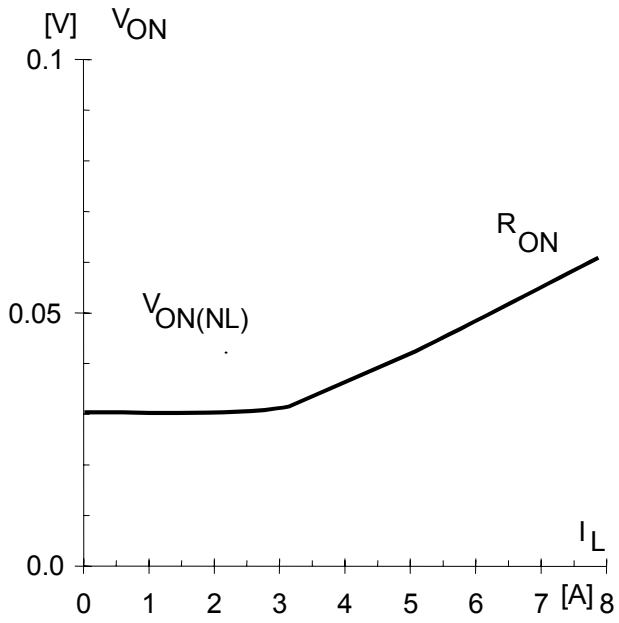


Figure 6b: Current sense ratio²²:



²² This range for the current sense ratio refers to all devices. The accuracy of the k_{ILIS} can be raised by means of calibration the value of k_{ILIS} for every single device.

Figure 7a: Output voltage drop versus load current:

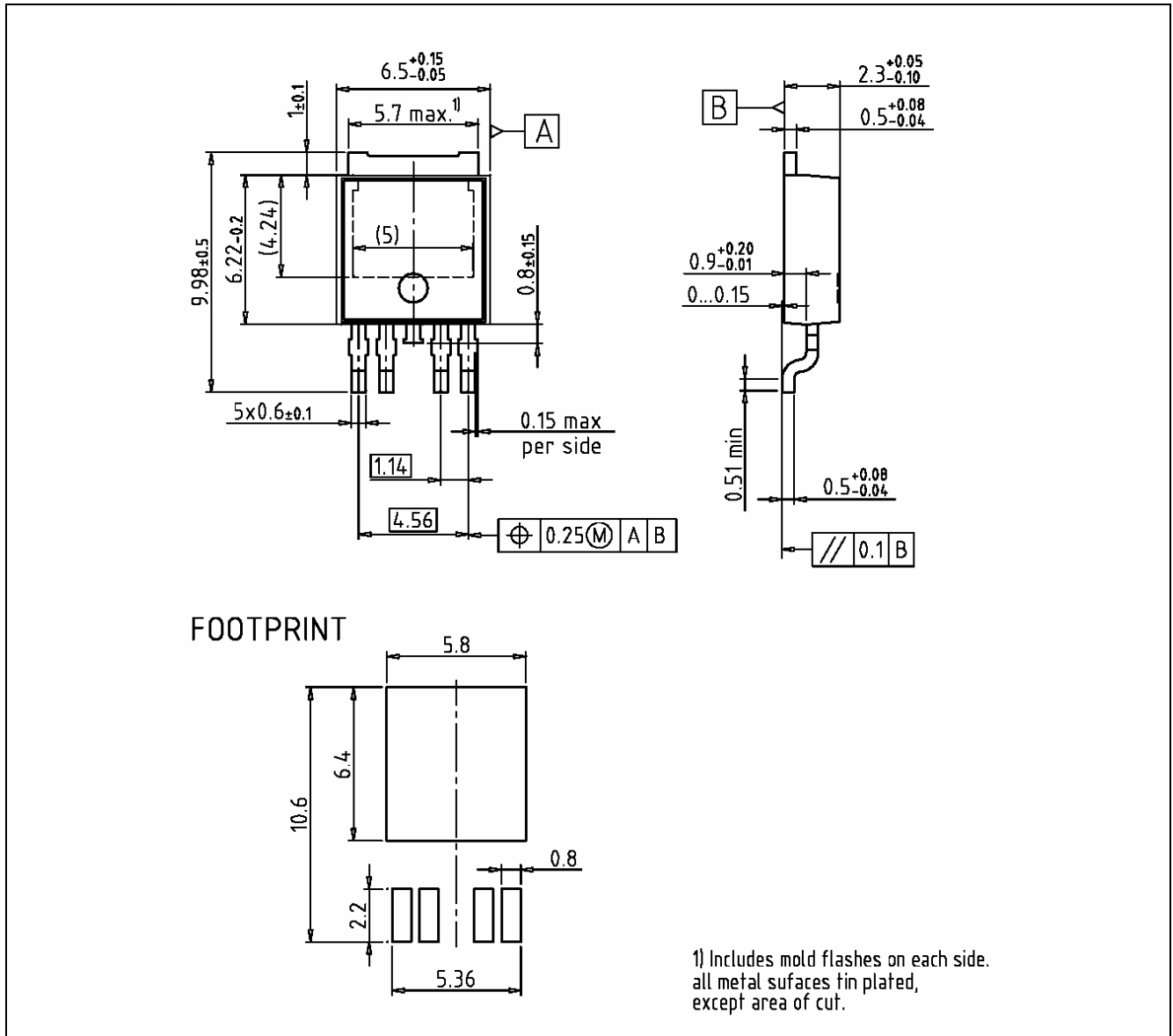


Package Outlines

All dimensions in mm

D-Pak-5 Pin: PG-TO252-5-11

Sales Code	BTS 6143 D
------------	------------



Green Product

To meet the world-wide customer requirements for environmentally friendly products and to be compliant with government regulations the device is available as a green product. Green products are RoHS-Compliant (i.e Pb-free finish on leads and suitable for Pb-free soldering according to IPC/JEDEC J-STD-020).

Revision History

Version	Date	Changes
Rev. 1.0	2007-02-21	RoHS-compliant version of BTS6143D Page 1, page 16: RoHS compliance statement and Green product feature added Page 1, page 16: Change to RoHS compliant package PG-TO252-5-11 Legal disclaimer updated

Edition 2007-02

**Published by
Infineon Technologies AG
81726 Munich, Germany**

**© Infineon Technologies AG 2007.
All Rights Reserved.**

Legal Disclaimer

The information given in this document shall in no event be regarded as a guarantee of conditions or characteristics ("Beschaffenheitsgarantie"). With respect to any examples or hints given herein, any typical values stated herein and/or any information regarding the application of the device, Infineon Technologies hereby disclaims any and all warranties and liabilities of any kind, including without limitation warranties of non-infringement of intellectual property rights of any third party.

Information

For further information on technology, delivery terms and conditions and prices please contact your nearest Infineon Technologies Office (www.infineon.com).

Warnings

Due to technical requirements components may contain dangerous substances. For information on the types in question please contact your nearest Infineon Technologies Office.

Infineon Technologies Components may only be used in life-support devices or systems with the express written approval of Infineon Technologies, if a failure of such components can reasonably be expected to cause the failure of that life-support device or system, or to affect the safety or effectiveness of that device or system. Life support devices or systems are intended to be implanted in the human body, or to support and/or maintain and sustain and/or protect human life. If they fail, it is reasonable to assume that the health of the user or other persons may be endangered.

单击下面可查看定价，库存，交付和生命周期等信息

[>>Infineon\(英飞凌\)](#)