

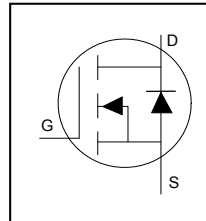
Application

- Brushed Motor drive applications
- BLDC Motor drive applications
- Battery powered circuits
- Half-bridge and full-bridge topologies
- Synchronous rectifier applications
- Resonant mode power supplies
- OR-ing and redundant power switches
- DC/DC and AC/DC converters
- DC/AC Inverters

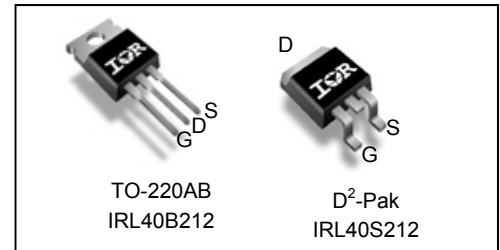
Benefits

- Optimized for Logic Level Drive
- Improved Gate, Avalanche and Dynamic dV/dt Ruggedness
- Fully Characterized Capacitance and Avalanche SOA
- Enhanced body diode dV/dt and dI/dt Capability
- Lead-Free
- RoHS Compliant, Halogen-Free

HEXFET® Power MOSFET



| | |
|--|--------------|
| V_{DSS} | 40V |
| R_{DS(on)} typ. | 1.5mΩ |
| max | 1.9mΩ |
| I_D (Silicon Limited) | 254A① |
| I_D (Package Limited) | 195A |



| | | |
|----------|----------|----------|
| G | D | S |
| Gate | Drain | Source |

| Base part number | Package Type | Standard Pack | | Orderable Part Number |
|------------------|--------------|---------------|----------|-----------------------|
| | | Form | Quantity | |
| IRL40B212 | TO-220 | Tube | 50 | IRL40B212 |
| IRL40S212 | D²-Pak | Tape and Reel | 800 | IRL40S212 |

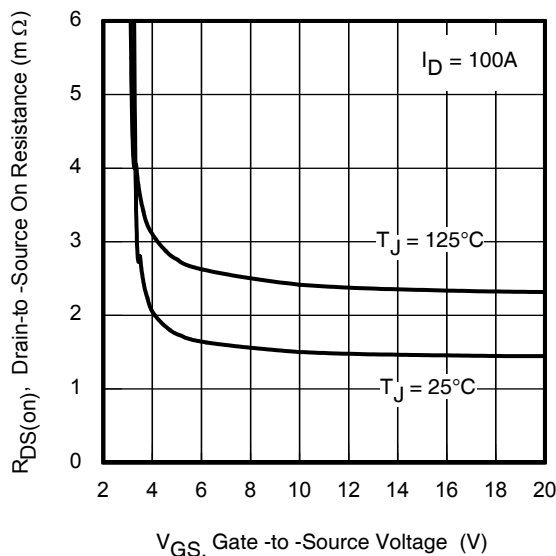


Fig 1. Typical On- Resistance vs. Gate Voltage

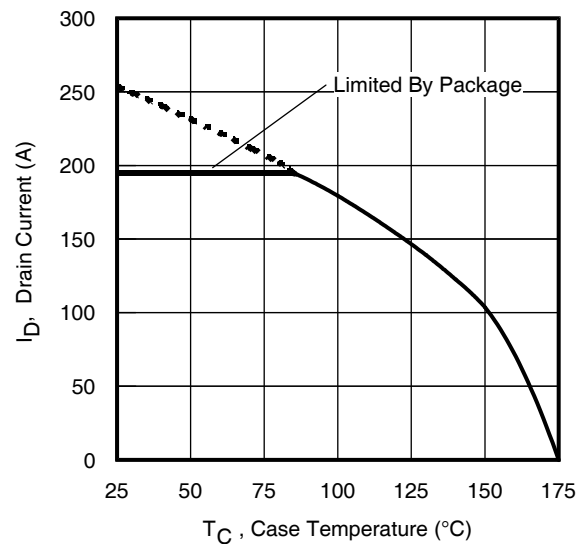


Fig 2. Maximum Drain Current vs. Case Temperature

Absolute Maximum Rating

| Symbol | Parameter | Max. | Units |
|---------------------------------|---|---------------------|-------|
| $I_D @ T_C = 25^\circ\text{C}$ | Continuous Drain Current, $V_{GS} @ 10\text{V}$ (Silicon Limited) | 254 ^① | A |
| $I_D @ T_C = 100^\circ\text{C}$ | Continuous Drain Current, $V_{GS} @ 10\text{V}$ (Silicon Limited) | 179 ^① | |
| $I_D @ T_C = 25^\circ\text{C}$ | Continuous Drain Current, $V_{GS} @ 10\text{V}$ (Wire Bond Limited) | 195 | |
| I_{DM} | Pulsed Drain Current ^② | 990 * | |
| $P_D @ T_C = 25^\circ\text{C}$ | Maximum Power Dissipation | 231 | W |
| | Linear Derating Factor | 1.5 | W/°C |
| V_{GS} | Gate-to-Source Voltage | ± 20 | V |
| T_J | Operating Junction and | -55 to + 175 | °C |
| T_{STG} | Storage Temperature Range | | |
| | Soldering Temperature, for 10 seconds (1.6mm from case) | | |
| | Mounting Torque, 6-32 or M3 Screw | 10 lbf-in (1.1 N·m) | |

Avalanche Characteristics

| | | | |
|------------------------------|--|--------------------------|----|
| E_{AS} (Thermally limited) | Single Pulse Avalanche Energy ^③ | 342 | mJ |
| E_{AS} (Thermally limited) | Single Pulse Avalanche Energy ^④ | 790 | |
| I_{AR} | Avalanche Current ^② | See Fig 15, 16, 23a, 23b | A |
| E_{AR} | Repetitive Avalanche Energy ^② | | mJ |

Thermal Resistance

| Symbol | Parameter | Typ. | Max. | Units |
|-----------------|--|------|------|-------|
| $R_{\theta JC}$ | Junction-to-Case ^⑤ | — | 0.65 | °C/W |
| $R_{\theta CS}$ | Case-to-Sink, Flat Greased Surface | 0.50 | — | |
| $R_{\theta JA}$ | Junction-to-Ambient | — | 62 | |
| $R_{\theta JA}$ | Junction-to-Ambient (PCB Mount) ^⑥ | — | 40 | |

Static @ $T_J = 25^\circ\text{C}$ (unless otherwise specified)

| Symbol | Parameter | Min. | Typ. | Max. | Units | Conditions |
|---------------------------------|--------------------------------------|------|------|------|-------|--|
| $V_{(BR)DSS}$ | Drain-to-Source Breakdown Voltage | 40 | — | — | V | $V_{GS} = 0\text{V}, I_D = 250\mu\text{A}$ |
| $\Delta V_{(BR)DSS}/\Delta T_J$ | Breakdown Voltage Temp. Coefficient | — | 0.03 | — | V/°C | Reference to $25^\circ\text{C}, I_D = 2\text{mA}$ ^② |
| $R_{DS(on)}$ | Static Drain-to-Source On-Resistance | — | 1.5 | 1.9 | mΩ | $V_{GS} = 10\text{V}, I_D = 100\text{A}$ ^⑤ |
| | | — | 1.9 | 2.4 | | $V_{GS} = 4.5\text{V}, I_D = 50\text{A}$ ^⑤ |
| $V_{GS(th)}$ | Gate Threshold Voltage | 1.0 | — | 2.4 | V | $V_{DS} = V_{GS}, I_D = 150\mu\text{A}$ |
| I_{DSS} | Drain-to-Source Leakage Current | — | — | 1.0 | μA | $V_{DS} = 40\text{V}, V_{GS} = 0\text{V}$ |
| | | — | — | 150 | | $V_{DS} = 40\text{V}, V_{GS} = 0\text{V}, T_J = 125^\circ\text{C}$ |
| I_{GSS} | Gate-to-Source Forward Leakage | — | — | 100 | nA | $V_{GS} = 20\text{V}$ |
| | Gate-to-Source Reverse Leakage | — | — | -100 | | $V_{GS} = -20\text{V}$ |
| R_G | Gate Resistance | — | 1.6 | — | Ω | |

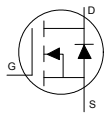
Notes:

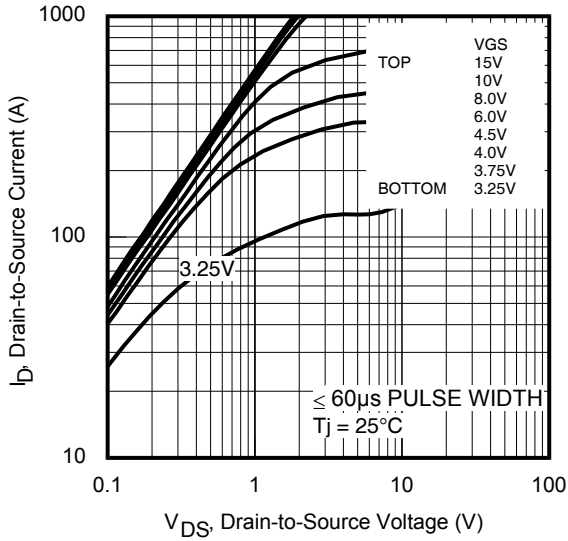
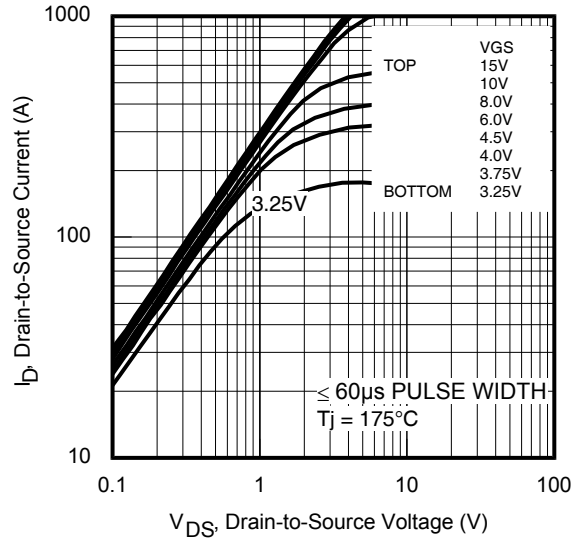
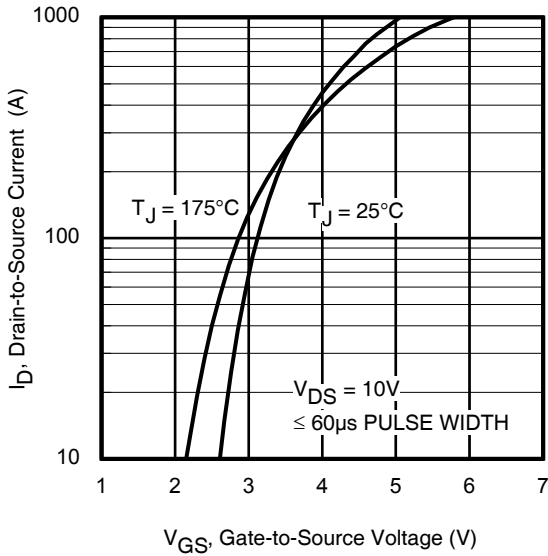
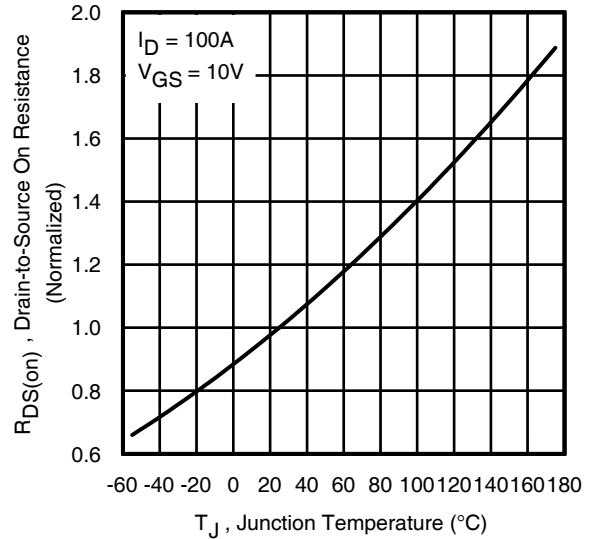
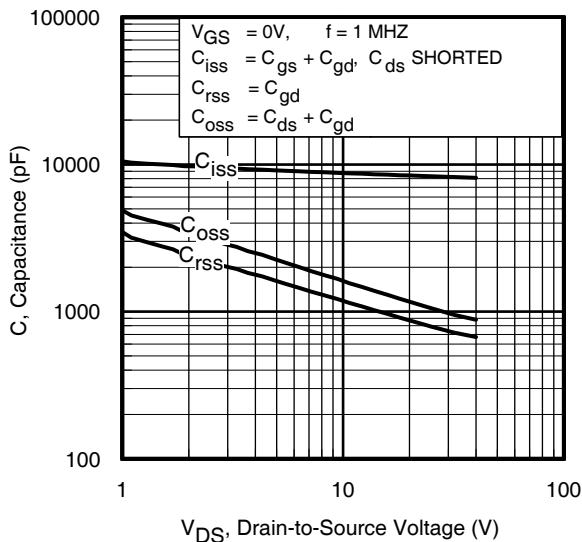
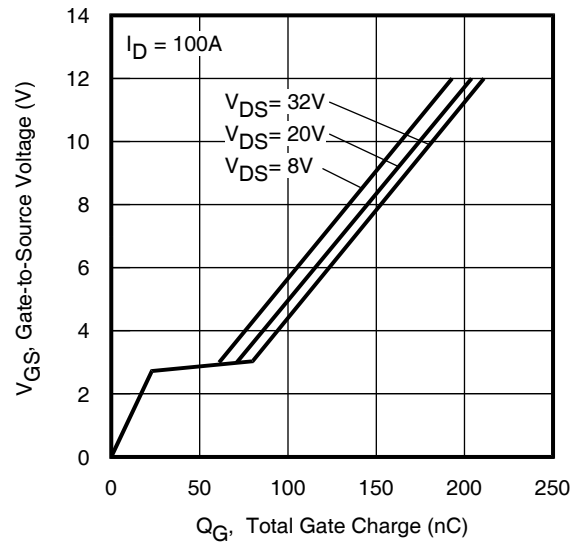
- ① Calculated continuous current based on maximum allowable junction temperature. Bond wire current limit is 195A. Note that current limitations arising from heating of the device leads may occur with some lead mounting arrangements. (Refer to AN-1140)
 - ② Repetitive rating; pulse width limited by max. junction temperature.
 - ③ Limited by T_{Jmax} , starting $T_J = 25^\circ\text{C}$, $L = 0.07\text{mH}$, $R_G = 50\Omega$, $I_{AS} = 100\text{A}$, $V_{GS} = 10\text{V}$.
 - ④ $I_{SD} \leq 100\text{A}$, $di/dt \leq 950\text{A}/\mu\text{s}$, $V_{DD} \leq V_{(BR)DSS}$, $T_J \leq 175^\circ\text{C}$.
 - ⑤ Pulse width $\leq 400\mu\text{s}$; duty cycle $\leq 2\%$.
 - ⑥ C_{oss} eff. (TR) is a fixed capacitance that gives the same charging time as C_{oss} while V_{DS} is rising from 0 to 80% V_{DSS} .
 - ⑦ C_{oss} eff. (ER) is a fixed capacitance that gives the same energy as C_{oss} while V_{DS} is rising from 0 to 80% V_{DSS} .
 - ⑧ R_θ is measured at T_J approximately 90°C .
 - ⑨ When mounted on 1 inch square PCB (FR-4). Please refer to AN-994 for more details:
<http://www.irf.com/technical-info/appnotes/an-994.pdf>
 - ⑩ Limited by T_{Jmax} , starting $T_J = 25^\circ\text{C}$, $L = 1\text{mH}$, $R_G = 50\Omega$, $I_{AS} = 40\text{A}$, $V_{GS} = 10\text{V}$.
- * Pulse drain current is limited at 780A by source bonding technology.

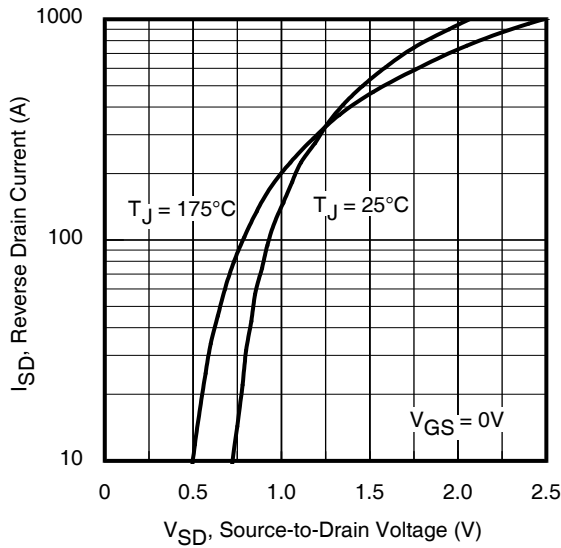
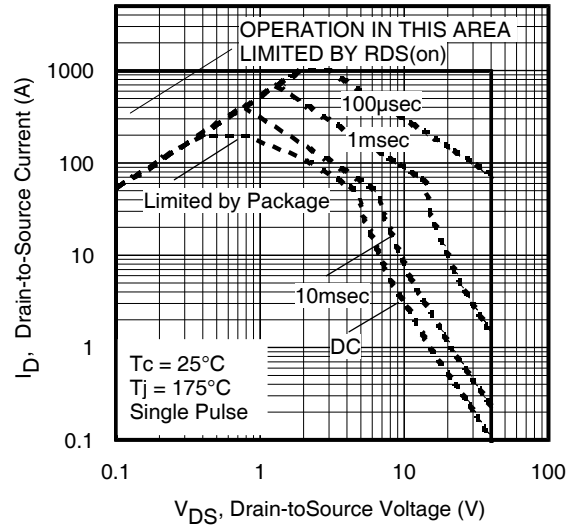
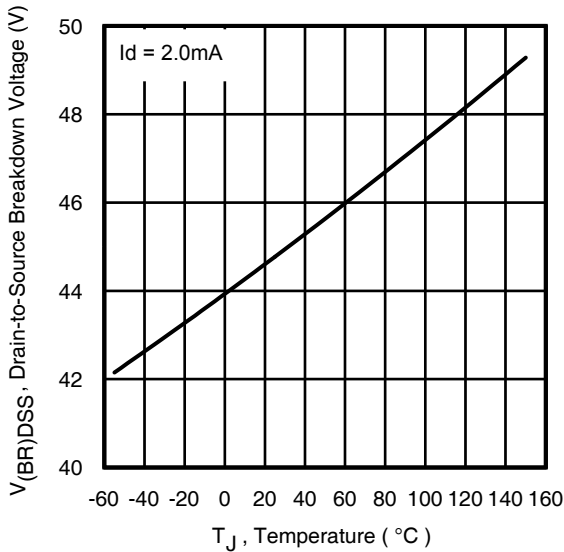
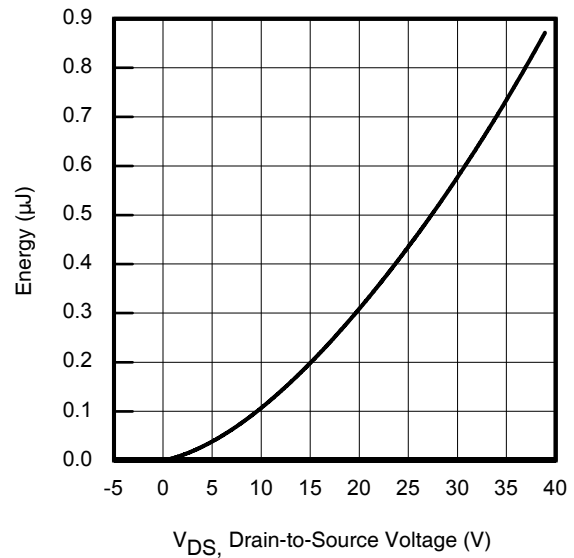
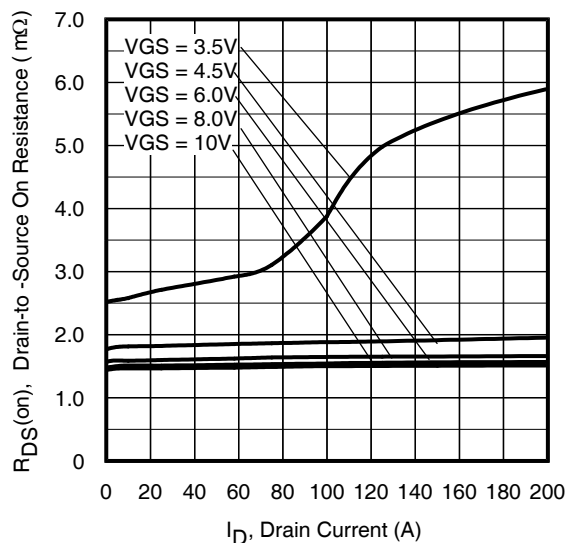
Dynamic Electrical Characteristics @ $T_J = 25^\circ\text{C}$ (unless otherwise specified)

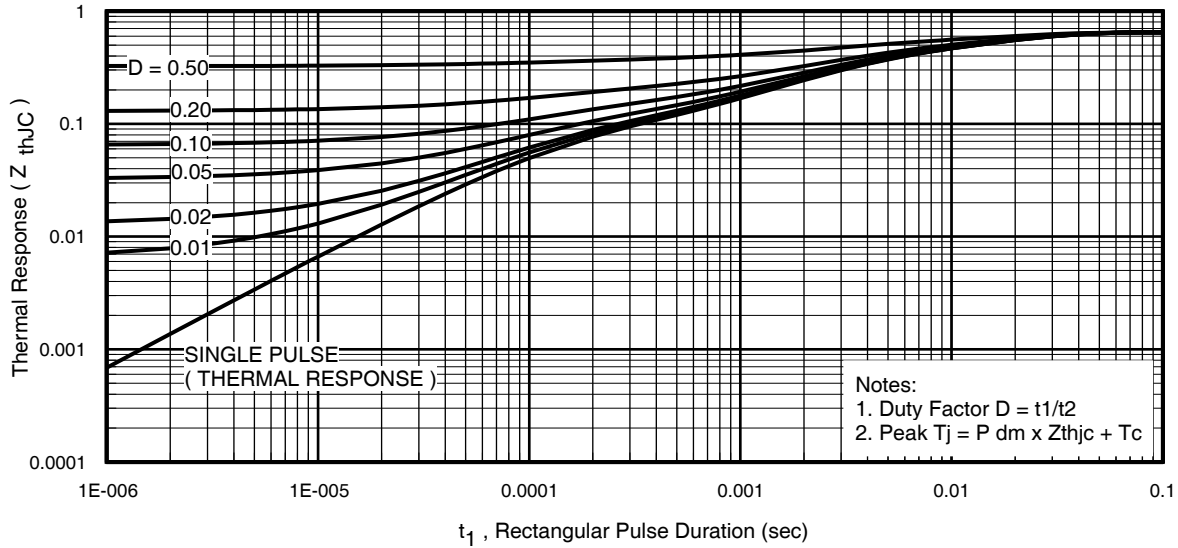
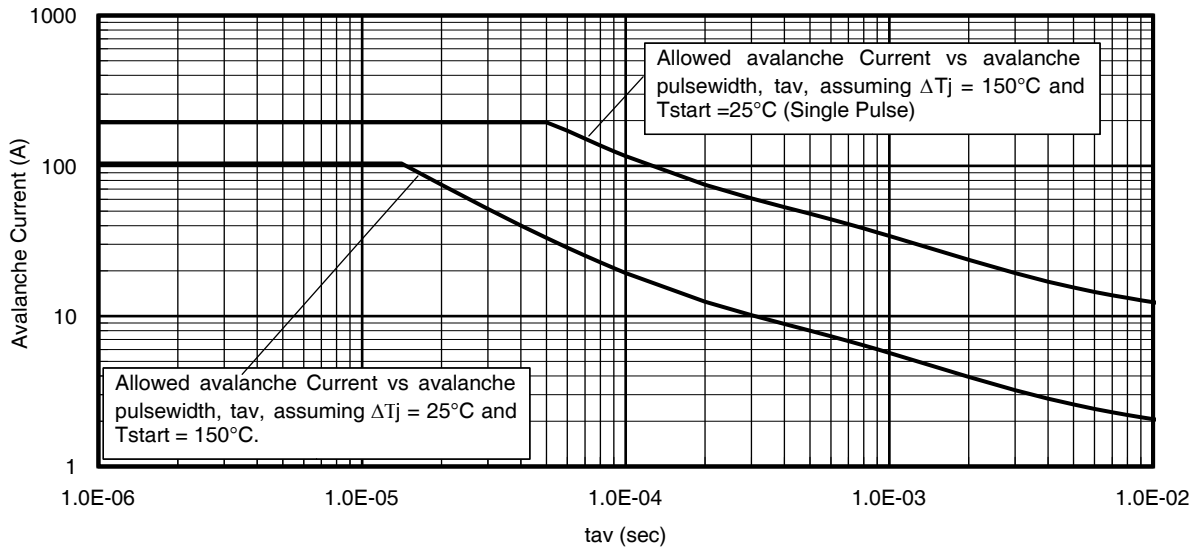
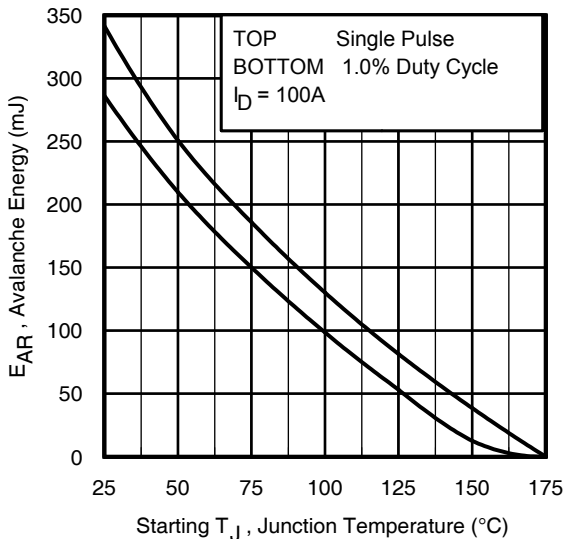
| Symbol | Parameter | Min. | Typ. | Max. | Units | Conditions |
|---------------------|---|------|------|------|-------|---|
| g_{fs} | Forward Transconductance | 256 | — | — | S | $V_{DS} = 10\text{V}, I_D = 100\text{A}$ |
| Q_g | Total Gate Charge | — | 91 | 137 | nC | $I_D = 100\text{A}$ $V_{DS} = 20\text{V}$ $V_{GS} = 4.5\text{V}^{\text{⑤}}$ |
| Q_{gs} | Gate-to-Source Charge | — | 25 | — | | |
| Q_{gd} | Gate-to-Drain Charge | — | 46 | — | | |
| Q_{sync} | Total Gate Charge Sync. ($Q_g - Q_{gd}$) | — | 45 | — | | |
| $t_{d(on)}$ | Turn-On Delay Time | — | 39 | — | ns | $V_{DD} = 20\text{V}$ $I_D = 30\text{A}$ $R_G = 2.7\Omega$ $V_{GS} = 4.5\text{V}^{\text{⑤}}$ |
| t_r | Rise Time | — | 154 | — | | |
| $t_{d(off)}$ | Turn-Off Delay Time | — | 88 | — | | |
| t_f | Fall Time | — | 84 | — | | |
| C_{iss} | Input Capacitance | — | 8320 | — | pF | $V_{GS} = 0\text{V}$ $V_{DS} = 25\text{V}$ $f = 1.0\text{MHz}$, See Fig.7 |
| C_{oss} | Output Capacitance | — | 1050 | — | | |
| C_{rssi} | Reverse Transfer Capacitance | — | 790 | — | | |
| $C_{oss\ eff.(ER)}$ | Effective Output Capacitance (Energy Related) | — | 1250 | — | | |
| $C_{oss\ eff.(TR)}$ | Output Capacitance (Time Related) | — | 1580 | — | | |

Diode Characteristics

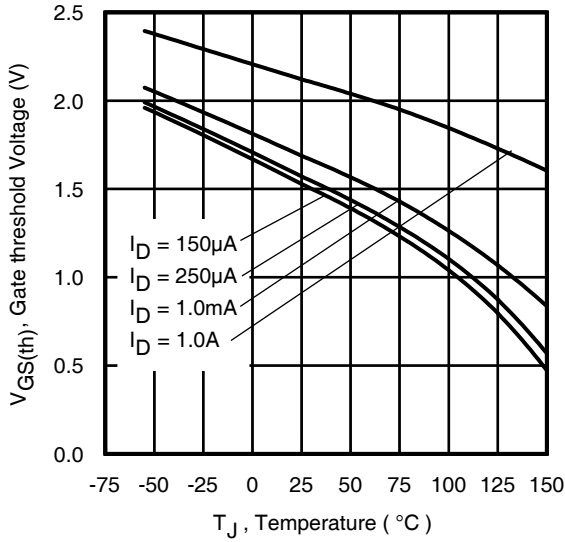
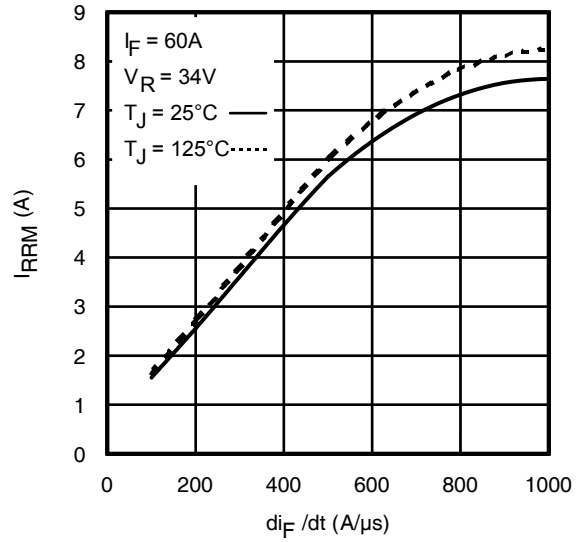
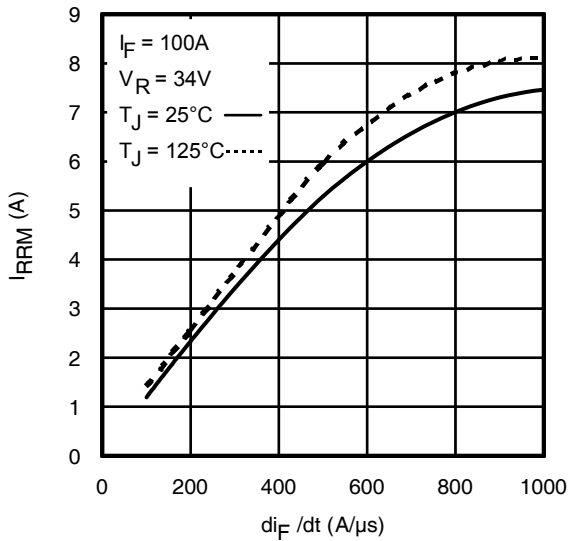
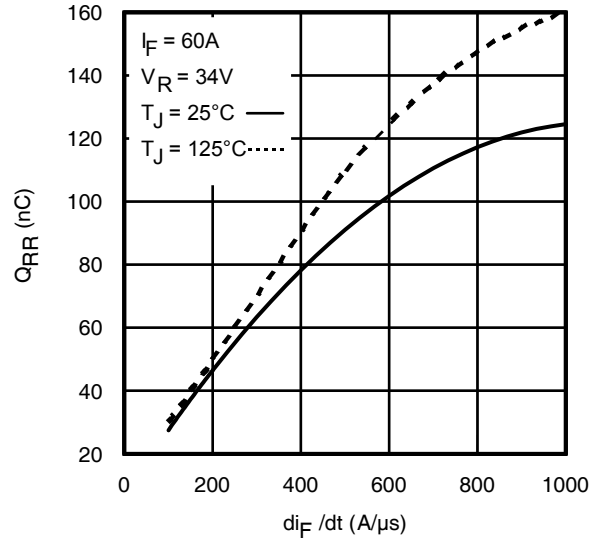
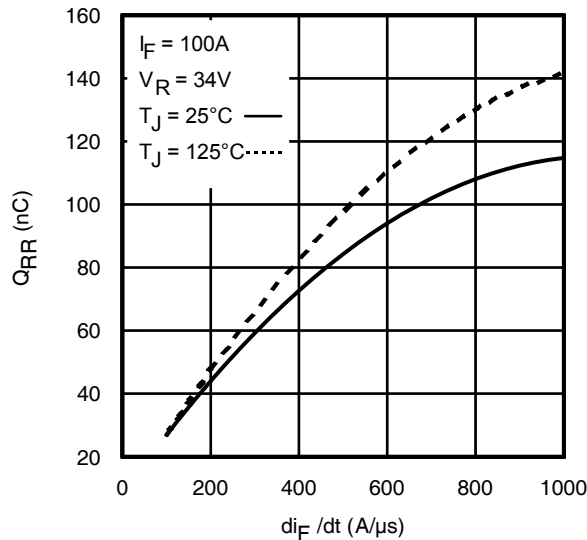
| Symbol | Parameter | Min. | Typ. | Max. | Units | Conditions |
|-----------|---|------|------|------------------|-------|---|
| I_S | Continuous Source Current (Body Diode) | — | — | 254 ^① | A | MOSFET symbol showing the integral reverse p-n junction diode.  |
| I_{SM} | Pulsed Source Current (Body Diode) ^② | — | — | 990* | | |
| V_{SD} | Diode Forward Voltage | — | — | 1.2 | V | $T_J = 25^\circ\text{C}, I_S = 100\text{A}, V_{GS} = 0\text{V}^{\text{⑤}}$ |
| dv/dt | Peak Diode Recovery dv/dt ^④ | — | 6.0 | — | V/ns | $T_J = 175^\circ\text{C}, I_S = 100\text{A}, V_{DS} = 40\text{V}$ |
| t_{rr} | Reverse Recovery Time | — | 30 | — | ns | $V_{DD} = 34\text{V}$ $I_F = 100\text{A}$, $di/dt = 100\text{A}/\mu\text{s}^{\text{⑤}}$ |
| | | — | 32 | — | | |
| Q_{rr} | Reverse Recovery Charge | — | 26 | — | nC | $T_J = 25^\circ\text{C}$ $T_J = 125^\circ\text{C}$ |
| | | — | 28 | — | | |
| I_{RRM} | Reverse Recovery Current | — | 1.4 | — | A | $T_J = 25^\circ\text{C}$ |

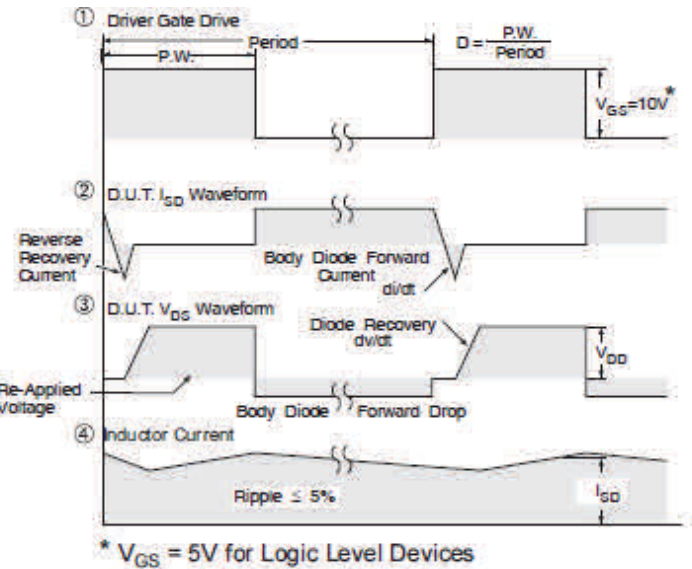
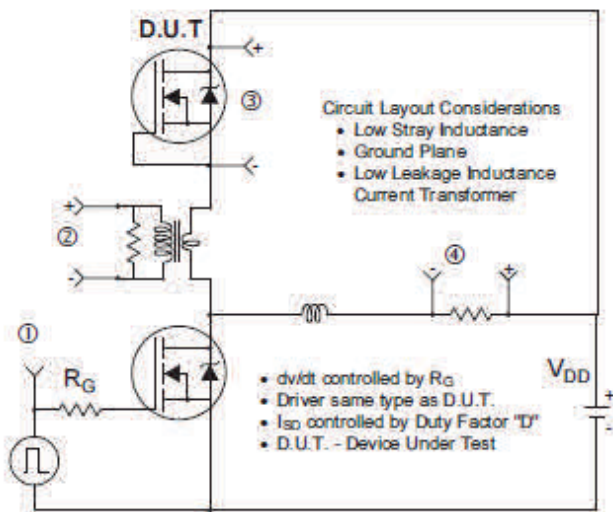
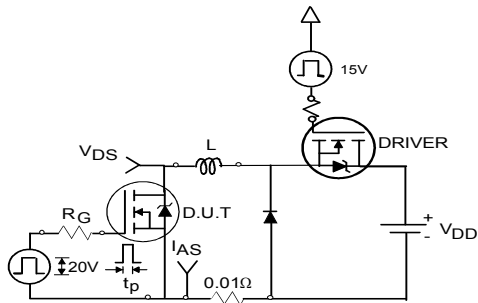
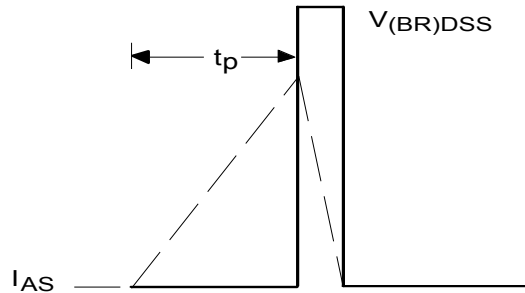
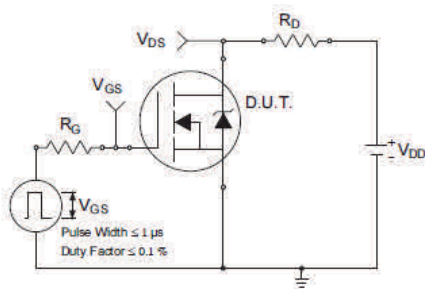
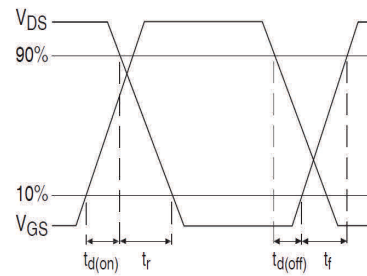
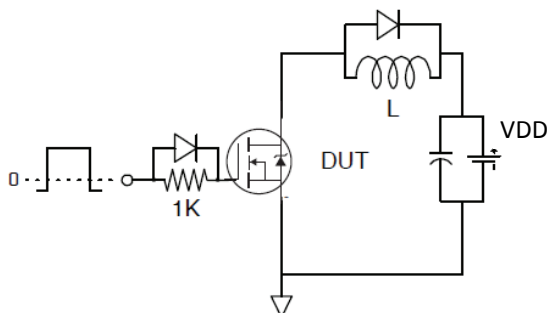
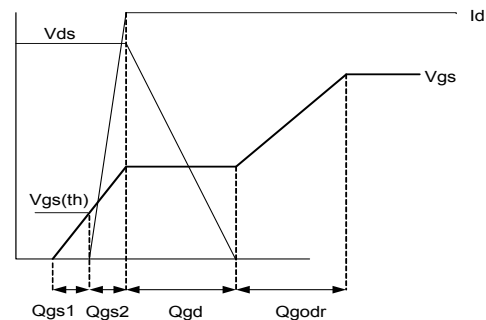

Fig 3. Typical Output Characteristics

Fig 4. Typical Output Characteristics

Fig 5. Typical Transfer Characteristics

Fig 6. Normalized On-Resistance vs. Temperature

Fig 7. Typical Capacitance vs. Drain-to-Source Voltage

Fig 8. Typical Gate Charge vs. Gate-to-Source Voltage

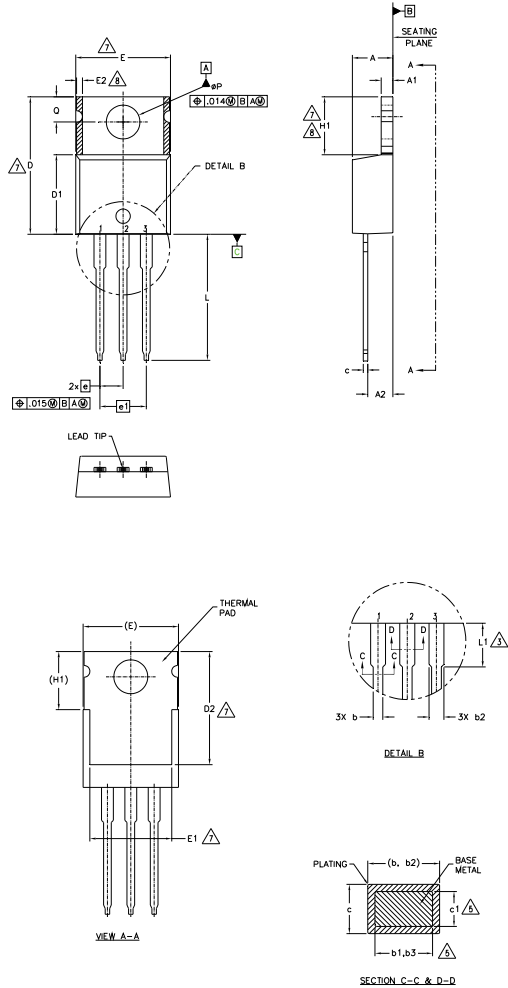

Fig 9. Typical Source-Drain Diode Forward Voltage

Fig 10. Maximum Safe Operating Area

Fig 11. Drain-to-Source Breakdown Voltage

Fig 12. Typical C_{oss} Stored Energy

Fig 13. Typical On-Resistance vs. Drain Current


Fig 14. Maximum Effective Transient Thermal Impedance, Junction-to-Case

Fig 15. Avalanche Current vs. Pulse Width

Fig 16. Maximum Avalanche Energy vs. Temperature
**Notes on Repetitive Avalanche Curves, Figures 15, 16:
(For further info, see AN-1005 at www.irf.com)**

1. Avalanche failures assumption:
Purely a thermal phenomenon and failure occurs at a temperature far in excess of T_{jmax} . This is validated for every part type.
2. Safe operation in Avalanche is allowed as long as T_{jmax} is not exceeded.
3. Equation below based on circuit and waveforms shown in Figures 23a, 23b.
4. $P_{D(ave)}$ = Average power dissipation per single avalanche pulse.
5. BV = Rated breakdown voltage (1.3 factor accounts for voltage increase during avalanche).
6. I_{av} = Allowable avalanche current.
7. ΔT = Allowable rise in junction temperature, not to exceed T_{jmax} (assumed as 25°C in Figure 14, 15).
 t_{av} = Average time in avalanche.
 D = Duty cycle in avalanche = $t_{av} \cdot f$
 $Z_{thJC}(D, t_{av})$ = Transient thermal resistance, see Figure 14)
 $P_{D(ave)} = 1/2 (1.3 \cdot BV \cdot I_{av}) = \Delta T / Z_{thJC}$
 $I_{av} = 2\Delta T / [1.3 \cdot BV \cdot Z_{th}]$
 $E_{AS(AR)} = P_{D(ave)} \cdot t_{av}$


Fig 17. Threshold Voltage vs. Temperature

Fig 18. Typical Recovery Current vs. di_F/dt

Fig 19. Typical Recovery Current vs. di_F/dt

Fig 20. Typical Stored Charge vs. di_F/dt

Fig 21. Typical Stored Charge vs. di_F/dt


Fig 22. Peak Diode Recovery dv/dt Test Circuit for N-Channel HEXFET® Power MOSFETs

Fig 23a. Unclamped Inductive Test Circuit

Fig 23b. Unclamped Inductive Waveforms

Fig 24a. Switching Time Test Circuit

Fig 24b. Switching Time Waveforms

Fig 25a. Gate Charge Test Circuit

Fig 25b. Gate Charge Waveform

TO-220AB Package Outline (Dimensions are shown in millimeters (inches))

NOTES:

- 1.- DIMENSIONING AND TOLERANCING AS PER ASME Y14.5 M- 1994.
- 2.- DIMENSIONS ARE SHOWN IN INCHES [MILLIMETERS].
- 3.- LEAD DIMENSION AND FINISH UNCONTROLLED IN L1.
- 4.- DIMENSION D, D1 & E DO NOT INCLUDE MOLD FLASH. MOLD FLASH SHALL NOT EXCEED .005" (0.127) PER SIDE. THESE DIMENSIONS ARE MEASURED AT THE OUTERMOST EXTREMES OF THE PLASTIC BODY.
- 5.- DIMENSION b1, b3 & c1 APPLY TO BASE METAL ONLY.
- 6.- CONTROLLING DIMENSION : INCHES.
- 7.- THERMAL PAD CONTOUR OPTIONAL WITHIN DIMENSIONS E,H1,D2 & E1
- 8.- DIMENSION E2 X H1 DEFINE A ZONE WHERE STAMPING AND SINGULATION IRREGULARITIES ARE ALLOWED.
- 9.- OUTLINE CONFORMS TO JEDEC TO-220, EXCEPT A2 (max.) AND D2 (min.) WHERE DIMENSIONS ARE DERIVED FROM THE ACTUAL PACKAGE OUTLINE.

| SYMBOL | DIMENSIONS | | | | NOTES |
|--------|-------------|-------|----------|------|-------|
| | MILLIMETERS | | INCHES | | |
| | MIN. | MAX. | MIN. | MAX. | |
| A | 3.56 | 4.83 | .140 | .190 | |
| A1 | 1.14 | 1.40 | .045 | .055 | |
| A2 | 2.03 | 2.92 | .080 | .115 | |
| b | 0.38 | 1.01 | .015 | .040 | |
| b1 | 0.38 | 0.97 | .015 | .038 | 5 |
| b2 | 1.14 | 1.78 | .045 | .070 | |
| b3 | 1.14 | 1.73 | .045 | .068 | 5 |
| c | 0.36 | 0.61 | .014 | .024 | |
| c1 | 0.36 | 0.56 | .014 | .022 | 5 |
| D | 14.22 | 16.51 | .560 | .650 | 4 |
| D1 | 8.38 | 9.02 | .330 | .355 | |
| D2 | 11.68 | 12.88 | .460 | .507 | 7 |
| E | 9.65 | 10.67 | .380 | .420 | 4,7 |
| E1 | 6.86 | 8.89 | .270 | .350 | 7 |
| E2 | - | 0.76 | - | .030 | 8 |
| e | 2.54 BSC | | .100 BSC | | |
| e1 | 5.08 BSC | | .200 BSC | | |
| H1 | 5.84 | 6.86 | .230 | .270 | 7,8 |
| L | 12.70 | 14.73 | .500 | .580 | |
| L1 | 3.56 | 4.06 | .140 | .160 | 3 |
| øP | 3.54 | 4.08 | .139 | .161 | |
| Q | 2.54 | 3.42 | .100 | .135 | |

LEAD ASSIGNMENTS
HEXFET

- 1.- GATE
- 2.- DRAIN
- 3.- SOURCE

IGBTs, CoPACK

- 1.- GATE
- 2.- COLLECTOR
- 3.- EMITTER

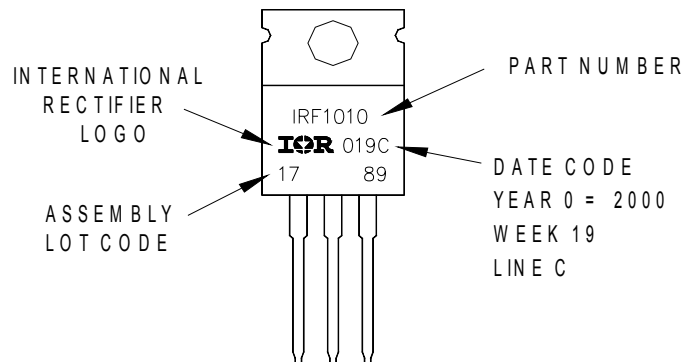
DIODES

- 1.- ANODE
- 2.- CATHODE
- 3.- ANODE

TO-220AB Part Marking Information

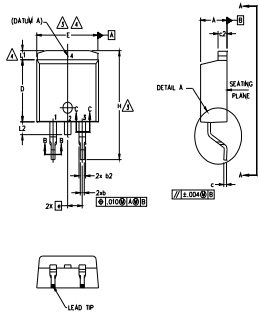
EXAMPLE: THIS IS AN IRF1010
 LOT CODE 1789
 ASSEMBLED ON WW 19, 2000
 IN THE ASSEMBLY LINE "C"

Note: "P" in assembly line position indicates "Lead - Free"

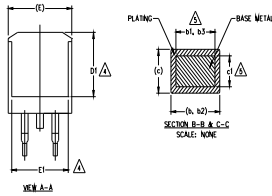
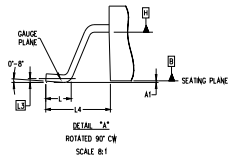


TO-220AB packages are not recommended for Surface Mount Application.

Note: For the most current drawing please refer to IR website at <http://www.irf.com/package/>

D²Pak (TO-263AB) Package Outline (Dimensions are shown in millimeters (inches))


- NOTES:
1. DIMENSIONING AND TOLERANCING PER ASME Y14.5M-1994
 2. DIMENSIONS ARE SHOWN IN MILLIMETERS [INCHES].
 3. DIMENSION D & E DO NOT INCLUDE MOLD FLASH. MOLD FLASH SHALL NOT EXCEED 0.127 [0.005"] PER SIDE. THESE DIMENSIONS ARE MEASURED AT THE OUTMOST EXTREMES OF THE PLASTIC BODY AT DATUM H.
 4. THERMAL PAD CONTOUR OPTIONAL WITHIN DIMENSION E, L1, D1 & E1.
 5. DIMENSION b1 AND c1 APPLY TO BASE METAL ONLY.
 6. DATUM A & B TO BE DETERMINED AT DATUM PLANE H.
 7. CONTROLLING DIMENSION: INCH.
 8. OUTLINE CONFORMS TO JEDEC OUTLINE TO-263AB.



| SYMBO L | DIMENSIONS | | | | NOTES |
|---------|-------------|-------|----------|------|-------|
| | MILLIMETERS | | INCHES | | |
| | MIN. | MAX. | MIN. | MAX. | |
| A | 4.06 | 4.83 | .160 | .190 | |
| A1 | 0.00 | 0.254 | .000 | .010 | |
| b | 0.51 | 0.99 | .020 | .039 | |
| b1 | 0.51 | 0.89 | .020 | .035 | 5 |
| b2 | 1.14 | 1.78 | .045 | .070 | |
| b3 | 1.14 | 1.73 | .045 | .068 | 5 |
| c | 0.38 | 0.74 | .015 | .029 | |
| c1 | 0.38 | 0.58 | .015 | .023 | 5 |
| c2 | 1.14 | 1.65 | .045 | .065 | |
| D | 8.38 | 9.65 | .330 | .380 | 3 |
| D1 | 6.86 | - | .270 | - | 4 |
| E | 9.65 | 10.67 | .380 | .420 | 3,4 |
| E1 | 6.22 | - | .245 | - | 4 |
| e | 2.54 BSC | | .100 BSC | | |
| H | 14.61 | 15.88 | .575 | .625 | |
| L | 1.78 | 2.79 | .070 | .110 | |
| L1 | - | 1.65 | - | .066 | 4 |
| L2 | 1.27 | 1.78 | - | .070 | |
| L3 | 0.25 BSC | | .010 BSC | | |
| L4 | 4.78 | 5.28 | .188 | .208 | |

LEAD ASSIGNMENTS
HEXFET

- 1.- GATE
- 2, 4.- DRAIN
- 3.- SOURCE

IGBTs, CoPACK

- 1.- GATE
- 2, 4.- COLLECTOR
- 3.- EMITTER

DIODES

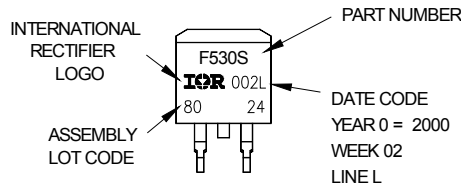
- 1.- ANODE *
- 2, 4.- CATHODE
- 3.- ANODE

* PART DEPENDENT.

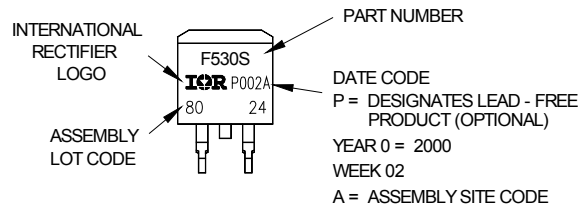
D²Pak (TO-263AB) Part Marking Information

EXAMPLE: THIS IS AN IRF530S WITH LOT CODE 8024 ASSEMBLED ON VW02, 2000 IN THE ASSEMBLY LINE "L"

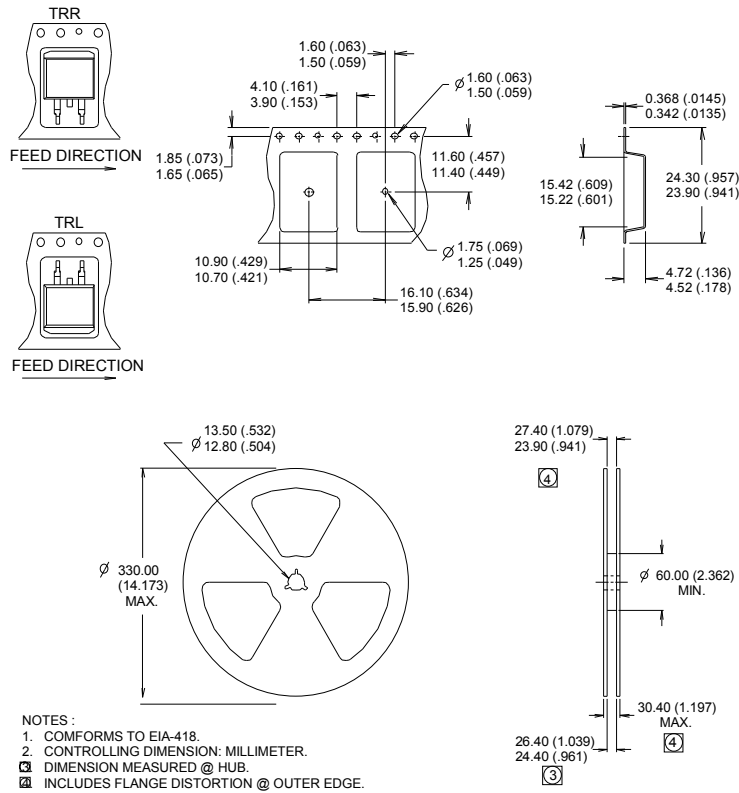
Note: "P" in assembly line position indicates "Lead - Free"



OR



Note: For the most current drawing please refer to IR website at <http://www.irf.com/package/>

D²Pak (TO-263AB) Tape & Reel Information (Dimensions are shown in millimeters (inches))


Note: For the most current drawing please refer to IR website at <http://www.irf.com/package/>

Qualification Information†

| | | |
|-----------------------------------|--------------------------------------|------|
| Qualification Level | Industrial (per JEDEC JESD47F) †† | |
| Moisture Sensitivity Level | TO-220 | N/A |
| | D ² Pak | MSL1 |
| RoHS Compliant | Yes | |

† Qualification standards can be found at International Rectifier’s web site: <http://www.irf.com/product-info/reliability/>

IMPORTANT NOTICE

The information given in this document shall in no event be regarded as a guarantee of conditions or characteristics ("Beschaffheitsgarantie").

With respect to any examples, hints or any typical values stated herein and/or any information regarding the application of the product, Infineon Technologies hereby disclaims any and all warranties and liabilities of any kind, including without limitation warranties of non-infringement of intellectual property rights of any third party.

In addition, any information given in this document is subject to customer's compliance with its obligations stated in this document and any applicable legal requirements, norms and standards concerning customer's products and any use of the product of Infineon Technologies in customer's applications.

The data contained in this document is exclusively intended for technically trained staff. It is the responsibility of customer's technical departments to evaluate the suitability of the product for the intended application and the completeness of the product information given in this document with respect to such application.

For further information on the product, technology, delivery terms and conditions and prices please contact your nearest Infineon Technologies office (www.infineon.com).

WARNINGS

Due to technical requirements products may contain dangerous substances. For information on the types in question please contact your nearest Infineon Technologies office.

Except as otherwise explicitly approved by Infineon Technologies in a written document signed by authorized representatives of Infineon Technologies, Infineon Technologies' products may not be used in any applications where a failure of the product or any consequences of the use thereof can reasonably be expected to result in personal injury.

单击下面可查看定价，库存，交付和生命周期等信息

[>>Infineon\(英飞凌\)](#)