

Easy 1B Module

CoolSiC™ Automotive MOSFET

FF08MR12W1MA1_B11A

Qualified for Automotive Applications. Product Validation according to AQC 324

Final Data Sheet

V3.1, 2020-09-15

Automotive High Power

1 Features / Description

EasyDUAL module with CoolSiC™ Automotive MOSFET and PressFIT / NTC

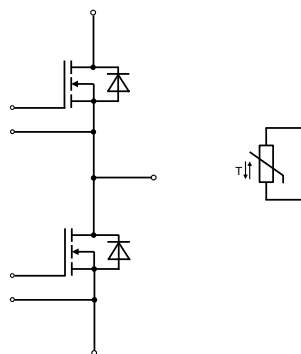
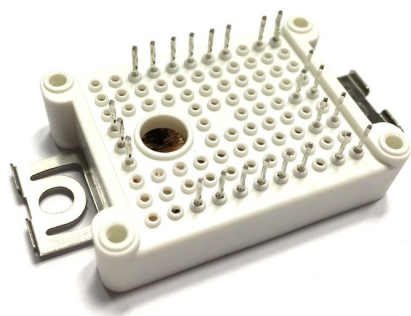

$V_{DSS} = 1200\text{ V}$
 $I_D = 150\text{ A}$

Typical Applications

- Automotive Applications
- Auxiliary Inverters
- DC/DC converter
- Hybrid Electrical Vehicles (H)EV

Electrical Features

- New semiconductor material - Silicon Carbide
- Blocking voltage 1200V
- Low R_{DSon}
- Low Switching Losses
- Low Q_g and Cr_{ss}
- Low Inductive Design
- $T_{vj\ op} = 150^\circ\text{C}$

Mechanical Features

- 5.1kV DC 1sec Insulation
- Compact design
- High Power Density
- Integrated NTC temperature sensor
- PressFIT Contact Technology
- RoHS compliant

Description

The Automotive CoolSiC™ EasyPACK™1B is a half bridge module which combines the benefits of Infineon's robust silicon carbide technology with a very compact and flexible package for hybrid and (fuel cell) electric vehicles. The power module implements the new CoolSiC™ Automotive MOSFET 1200V Gen1, optimized for high voltage applications like DC/DC converter and Auxiliary inverter. The chipset offers benchmark current density, high block voltage and reduced switching losses, which allows compact designs and helps to improve system efficiency, as well as allows a reliable operation under harsh environmental conditions.

It is qualified for Automotive Applications and validated according to AQC 324.

The Automotive CoolSiC™ EasyPACK™1B power module family comes with mechanical guiding elements and mounting clamps supporting easy assembly processes for customers. Furthermore, the press-fit pins for the signal terminals avoid additional time consuming selective solder processes, which provides cost savings on system level and increases system reliability. The Automotive CoolSiC™ EasyPACK™1B allows a flexible cooler and application construction. Due to the high clearance & creepage distances, the module family is also well suited for increased system working voltages and supports modular approaches.

Product Name	Ordering Code
FF08MR12W1MA1_B11A	SP002314006

2 MOSFET

2.1 Maximum Rated Values

Parameter	Conditions	Symbol	Value	Unit
Drain-source voltage	$T_{vj} = 25^{\circ}\text{C}$	V_{DSS}	1200	V
DC drain current	$T_{vj} = 175^{\circ}\text{C}, V_{GS} = 15\text{ V}$ $T_H = 65^{\circ}\text{C}$	$I_{D\text{ nom}}$	150	A
Pulsed drain current	verified by design, t_p limited by $T_{vj\text{ max}}$	$I_{D\text{ pulse}}$	300	A
Gate-source voltage		V_{GSS}	-10/20	V

2.2 Characteristic Values

Parameter	Conditions	Symbol	min. typ. max.			Unit	
Drain-source on resistance	$I_{D\text{ nom}} = 150\text{ A}$ $V_{GS} = 15\text{ V}$	$T_{vj} = 25^{\circ}\text{C}$ $T_{vj} = 125^{\circ}\text{C}$ $T_{vj} = 150^{\circ}\text{C}$	$R_{D\text{S on}}$	7.33 10.6 12.1	9.80	m Ω	
Gate threshold voltage	$I_D = 90.0\text{ mA}, V_{DS} = V_{GS}$ (tested after 1ms pulse at $V_{GS} = +20\text{ V}$)	$T_{vj} = 25^{\circ}\text{C}$	$V_{GS(\text{th})}$	3.25	4.40	5.55	V
Total gate charge	$V_{GS} = -5/15\text{ V}, V_{DS} = 600\text{ V}$		Q_G	0.495		μC	
Internal gate resistor		$T_{vj} = 25^{\circ}\text{C}$	$R_{G\text{int}}$	0.6		Ω	
Input capacitance	$f = 1\text{ MHz}, V_{GS} = 0\text{ V}$ $V_{DS} = 600\text{ V}$	$T_{vj} = 25^{\circ}\text{C}$	C_{iss}	16.0		nF	
Output capacitance	$f = 1\text{ MHz}, V_{GS} = 0\text{ V}$ $V_{DS} = 600\text{ V}$	$T_{vj} = 25^{\circ}\text{C}$	C_{oss}	0.70		nF	
Reverse transfer capacitance	$f = 1\text{ MHz}, V_{GS} = 0\text{ V}$ $V_{DS} = 600\text{ V}$	$T_{vj} = 25^{\circ}\text{C}$	C_{rss}	0.06		nF	
C_{oss} stored energy	$V_{DS} = 600\text{ V}, V_{GS} = -5/15\text{ V}$	$T_{vj} = 25^{\circ}\text{C}$	E_{OSS}	164		μJ	
Drain-source leakage current	$V_{DSS} = 1200\text{ V}, V_{GS} = -5\text{ V}$	$T_{vj} = 25^{\circ}\text{C}$	$I_{D\text{ SX}}$		100	μA	
Gate-source leakage current	$V_{DS} = 0\text{ V}, T_{vj} = 25^{\circ}\text{C}$	$V_{GS} = 20\text{ V}$	$I_{G\text{SS}}$		400	nA	
Turn on delay time, inductive load	$I_{D\text{ nom}} = 150\text{ A}, R_{G\text{on}} = 5.10\ \Omega$ $V_{DS} = 600\text{ V}$ $V_{GS} = -5/15\text{ V}$	$T_{vj} = 25^{\circ}\text{C}$ $T_{vj} = 125^{\circ}\text{C}$ $T_{vj} = 150^{\circ}\text{C}$	$t_{d\text{ on}}$	53.0 48.0 46.0		ns	
Rise time, inductive load	$I_{D\text{ nom}} = 150\text{ A}, R_{G\text{on}} = 5.10\ \Omega$ $V_{DS} = 600\text{ V}$ $V_{GS} = -5/15\text{ V}$	$T_{vj} = 25^{\circ}\text{C}$ $T_{vj} = 125^{\circ}\text{C}$ $T_{vj} = 150^{\circ}\text{C}$	t_r	35.0 34.0 33.0		ns	
Turn off delay time, inductive load	$I_{D\text{ nom}} = 150\text{ A}, R_{G\text{off}} = 5.10\ \Omega$ $V_{DS} = 600\text{ V}$ $V_{GS} = -5/15\text{ V}$	$T_{vj} = 25^{\circ}\text{C}$ $T_{vj} = 125^{\circ}\text{C}$ $T_{vj} = 150^{\circ}\text{C}$	$t_{d\text{ off}}$	146 148 149		ns	
Fall time, inductive load	$I_{D\text{ nom}} = 150\text{ A}, R_{G\text{off}} = 5.10\ \Omega$ $V_{DS} = 600\text{ V}$ $V_{GS} = -5/15\text{ V}$	$T_{vj} = 25^{\circ}\text{C}$ $T_{vj} = 125^{\circ}\text{C}$ $T_{vj} = 150^{\circ}\text{C}$	t_f	38.0 38.0 39.0		ns	
Turn-on energy loss per pulse	$I_{D\text{ nom}} = 150\text{ A}, V_{GS} = -5/15\text{ V}$ $V_{DS} = 600\text{ V}, R_{G\text{on}} = 5.10\ \Omega$ $L_S = 20\text{ nH}$ $di/dt = 4.92\text{ kA}/\mu\text{s}$ ($T_{vj\text{ op}} = 150^{\circ}\text{C}$)	$T_{vj} = 25^{\circ}\text{C}$ $T_{vj} = 125^{\circ}\text{C}$ $T_{vj} = 150^{\circ}\text{C}$	E_{on}	4.26 5.01 5.29		mJ	
Turn-off energy loss per pulse	$I_{D\text{ nom}} = 150\text{ A}, V_{GS} = -5/15\text{ V}$ $V_{DS} = 600\text{ V}, R_{G\text{off}} = 5.10\ \Omega$ $L_S = 20\text{ nH}$ $du/dt = 15.5\text{ kV}/\mu\text{s}$ ($T_{vj\text{ op}} = 150^{\circ}\text{C}$)	$T_{vj} = 25^{\circ}\text{C}$ $T_{vj} = 125^{\circ}\text{C}$ $T_{vj} = 150^{\circ}\text{C}$	E_{off}	2.67 2.73 2.76		mJ	
SC data	$V_{GS} = -5/15\text{ V}, R_G = 5.10\ \Omega$ $V_{DD} = 800\text{ V}$ $V_{D\text{Smax}} = V_{DSS} - L_{\text{SDS}} \cdot di/dt$	$t_p \leq 3\ \mu\text{s}, T_{vj} = 150^{\circ}\text{C}$ $t_p \leq 3\ \mu\text{s}, T_{vj} = 25^{\circ}\text{C}$	I_{SC}	2000 2200		A	
Thermal resistance, junction to heatsink	per MOSFET		R_{thJH}	0.460	0.550	K/W	
Temperature under switching conditions			$T_{vj\text{ op}}$	-40	150	$^{\circ}\text{C}$	

3 Body diode

3.1 Maximum Rated Values

Parameter	Conditions	Symbol	Value	Unit
DC body diode forward current	$T_{vj} = 175^{\circ}\text{C}$, $V_{GS} = -5\text{ V}$ $T_H = 65^{\circ}\text{C}$	I_{SD}	60	A
Pulsed body diode current	verified by design, t_p limited by T_{vjmax}	$I_{SD\ pulse}$	300	A

3.2 Characteristic Values

Parameter	Conditions	Symbol	Value			Unit
			min.	typ.	max.	
Forward voltage	$I_{SD} = 150\text{ A}$, $V_{GS} = -5\text{ V}$	V_{DSR}	$T_{vj} = 25^{\circ}\text{C}$ $T_{vj} = 125^{\circ}\text{C}$ $T_{vj} = 150^{\circ}\text{C}$	4.40 4.18 4.12	5.95	V
Peak reverse recovery current	$I_{SD} = 150\text{ A}$, $V_{GS} = -5\text{ V}$ $-di_S/dt = 6.10\text{ kA}/\mu\text{s}$ $V_R = 600\text{ V}$	I_{rrm}	$T_{vj} = 25^{\circ}\text{C}$ $T_{vj} = 125^{\circ}\text{C}$ $T_{vj} = 150^{\circ}\text{C}$	75.0 135 158		A
Recovered charge	$I_{SD} = 150\text{ A}$, $V_{GS} = -5\text{ V}$ $-di_S/dt = 6.10\text{ kA}/\mu\text{s}$ $V_R = 600\text{ V}$	Q_{rr}	$T_{vj} = 25^{\circ}\text{C}$ $T_{vj} = 125^{\circ}\text{C}$ $T_{vj} = 150^{\circ}\text{C}$	2.58 4.10 5.13		μC
Reverse recovery energy	$I_{SD} = 150\text{ A}$, $V_{GS} = -5\text{ V}$ $-di_S/dt = 6.10\text{ kA}/\mu\text{s}$ $V_R = 600\text{ V}$	E_{rec}	$T_{vj} = 25^{\circ}\text{C}$ $T_{vj} = 125^{\circ}\text{C}$ $T_{vj} = 150^{\circ}\text{C}$	0.48 0.95 1.35		mJ

4 NTC-Thermistor

Parameter	Conditions	Symbol	Value			Unit
			min.	typ.	max.	
Rated resistance	$T_C = 25^{\circ}\text{C}$	R_{25}		5.00		$\text{k}\Omega$
Deviation of R100	$T_C = 100^{\circ}\text{C}$, $R_{100} = 493\ \Omega$	$\Delta R/R$	-5		5	%
Power dissipation	$T_C = 25^{\circ}\text{C}$	P_{25}			20.0	mW
B-value	$R_2 = R_{25} \exp [B_{25/50}(1/T_2 - 1/(298,15\text{ K}))]$	$B_{25/50}$		3375		K
B-value	$R_2 = R_{25} \exp [B_{25/80}(1/T_2 - 1/(298,15\text{ K}))]$	$B_{25/80}$		3411		K
B-value	$R_2 = R_{25} \exp [B_{25/100}(1/T_2 - 1/(298,15\text{ K}))]$	$B_{25/100}$		3433		K

Specification according to the valid application note.

5 Module

Parameter	Conditions	Symbol	Value			Unit
			min.	typ.	max.	
Isolation test voltage	RMS, $f = 0\text{ Hz}$, $t = 1\text{ sec}$	V_{ISOL}		5.1		kV
Internal isolation	basic insulation (class 1, IEC 61140)			Al_2O_3		
Creepage distance	terminal to heatsink terminal to terminal	d_{Creep}		11.5 8.0		mm
Clearance	terminal to heatsink terminal to terminal	d_{Clear}		10.0 5.5		mm
Comperative tracking index		CTI		> 200		
Stray inductance module		L_{sCE}		5.0		nH
Module lead resistance, terminals - chip	$T_C = 25^{\circ}\text{C}$, per switch	$R_{AA'+CC'}$		1.00		m Ω
Storage temperature		T_{stg}	-40		150	$^{\circ}\text{C}$
Mounting force per clamp		F	20	-	50	N
Weight		G		24		g

6 Characteristics Diagrams

output characteristic MOSFET (typical)

$I_D = f(V_{DS})$
 $V_{GS} = 15\text{ V}$

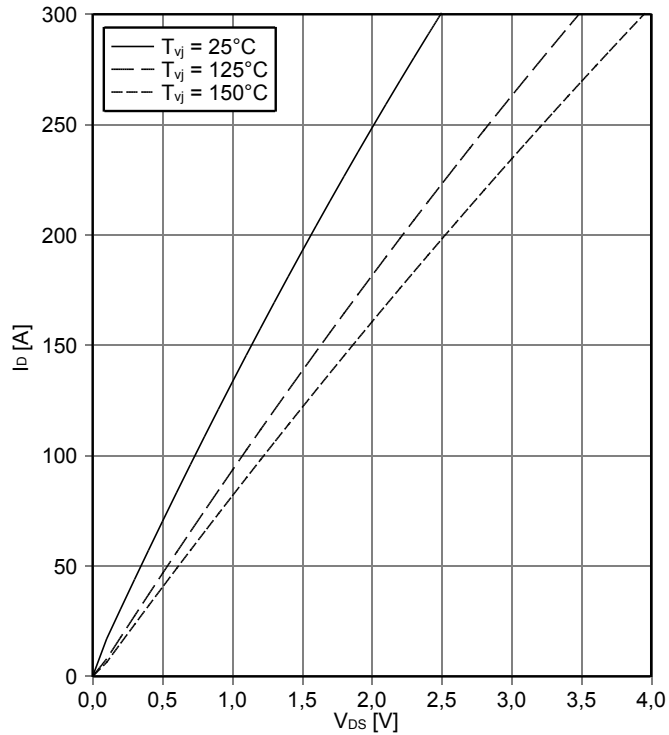

output characteristic MOSFET (typical)

$I_D = f(V_{DS})$
 $T_{vj} = 150^\circ\text{C}$

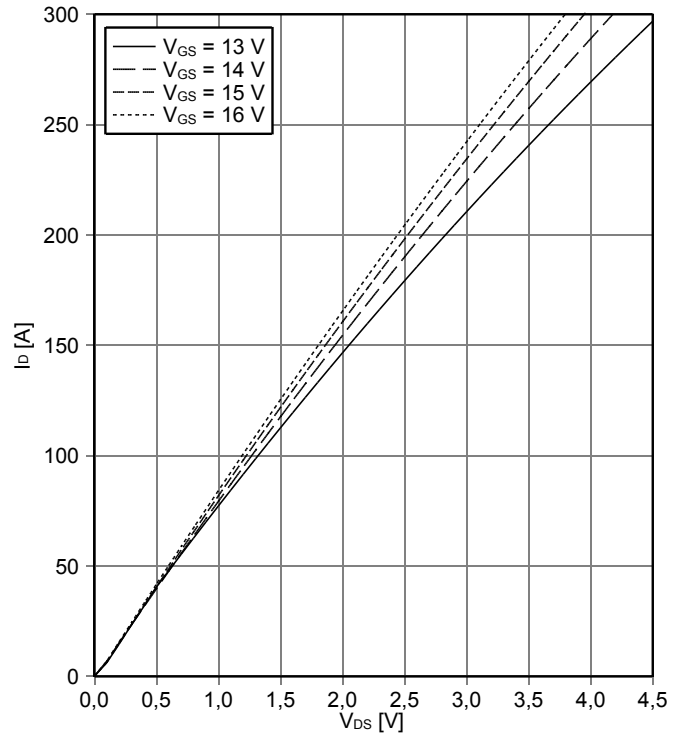

transfer characteristic MOSFET (typical)

$I_D = f(V_{GS})$
 $V_{DS} = 20\text{ V}$

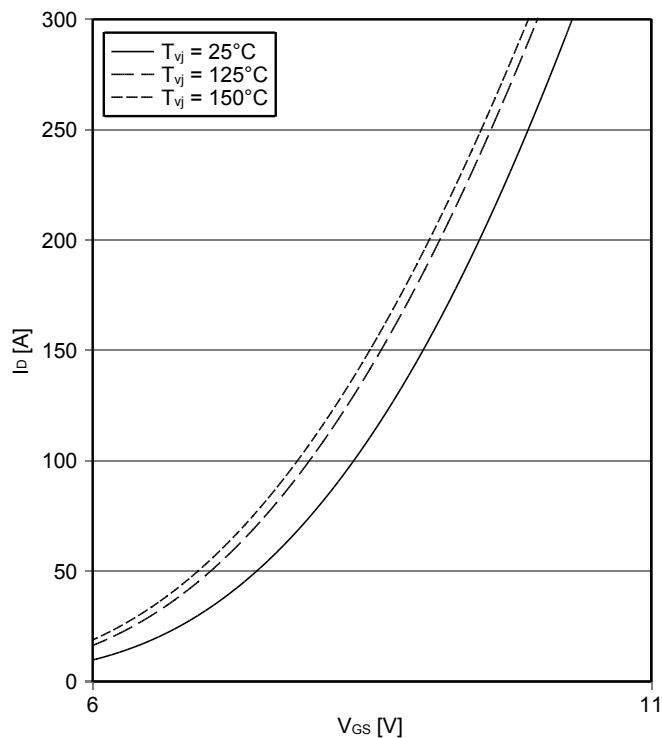

drain source on-resistance MOSFET (typical)

$R_{DS(on)} = f(T_j)$
 $V_{GS} = 15\text{ V}; I_D = 150\text{ A}$

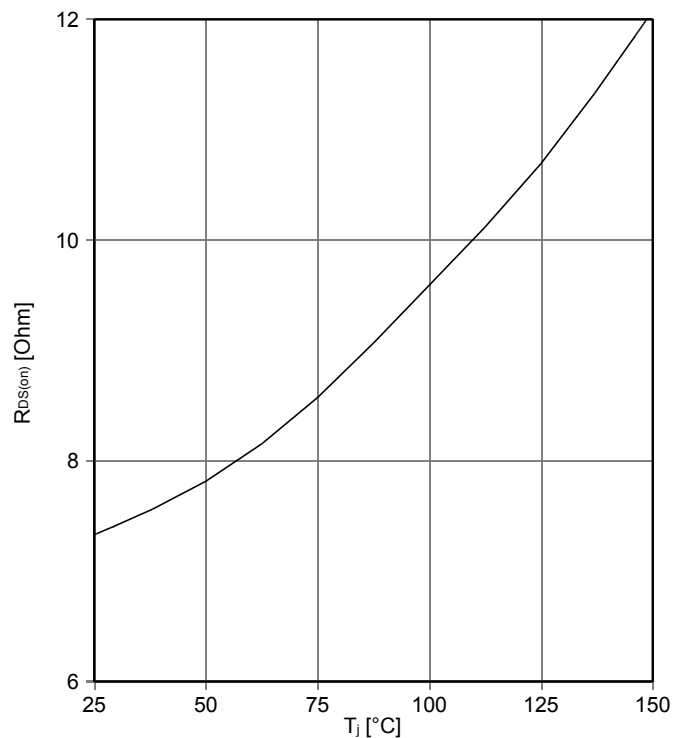

drain source on-resistance MOSFET (typical)

$R_{DS(on)} = f(T_j)$
 $V_{GS} = 15\text{ V}$

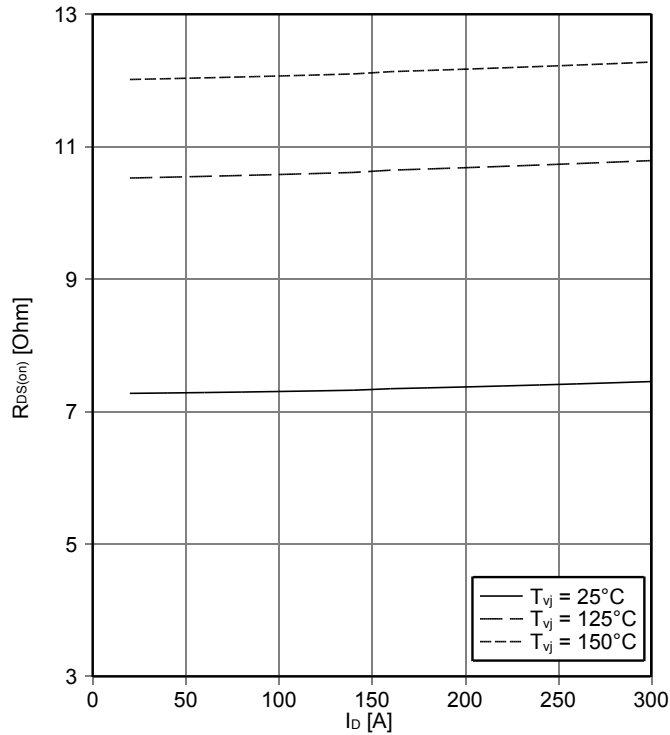

capacity characteristic MOSFET (typical)

$C = f(V_{DS})$
 $V_{GS} = 0\text{ V}, T_{vj} = 25^\circ\text{C}, f = 100\text{ kHz}$

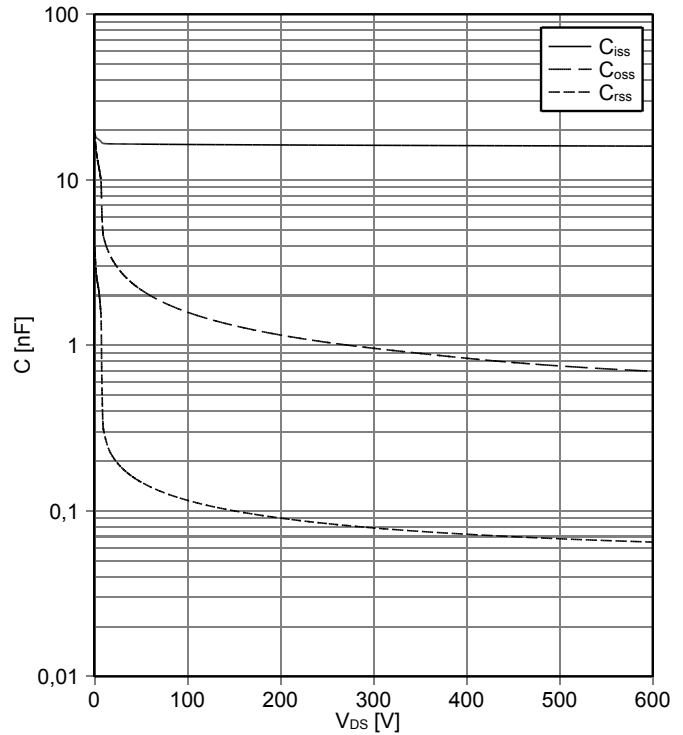

switching losses MOSFET (typical)

$E_{on} = f(I_D), E_{off} = f(I_D)$
 $V_{GS} = -5\text{ V} / +15\text{ V}, R_{Gon} = R_{Goff} = 5.1\ \Omega, V_{DS} = 600\text{ V}$

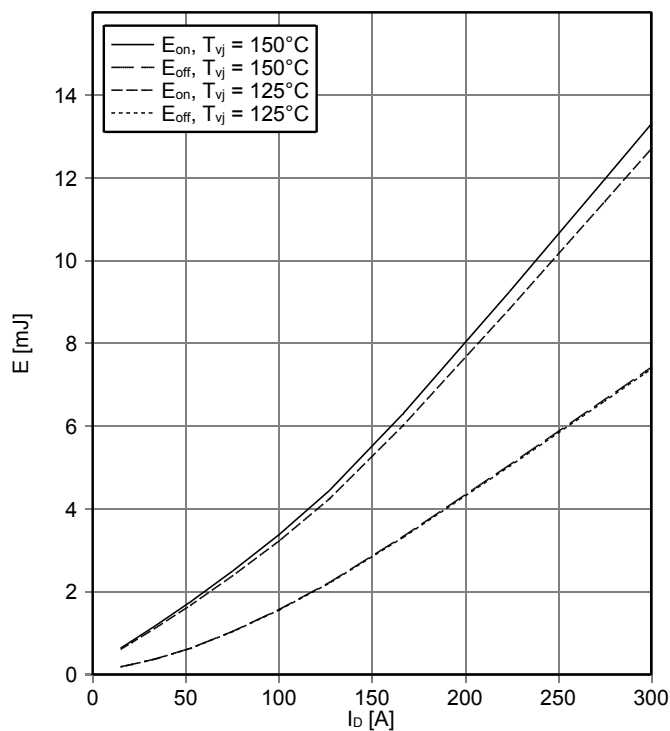

switching losses MOSFET (typical)

$E_{on} = f(R_G), E_{off} = f(R_G)$
 $V_{GS} = -5\text{ V} / +15\text{ V}, I_D = 150\text{ A}, V_{DS} = 600\text{ V}$

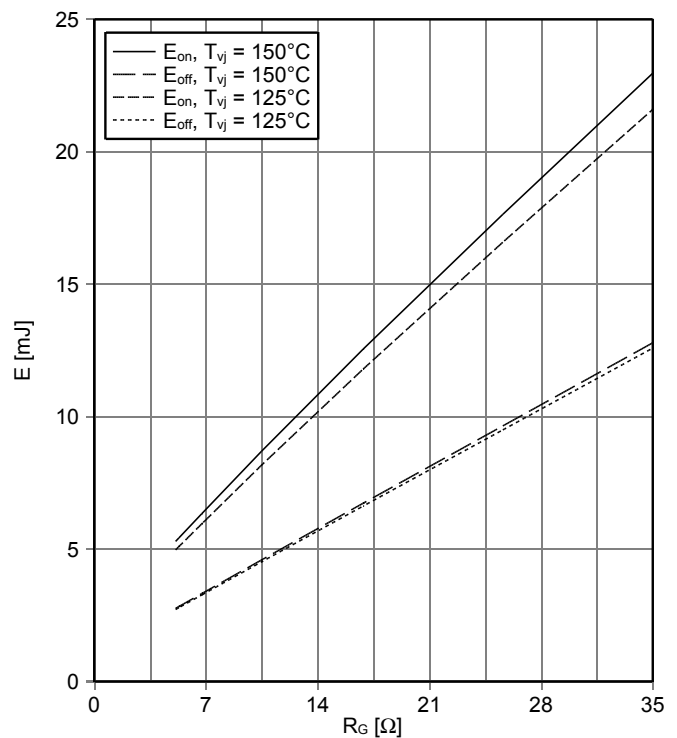

transient thermal impedance MOSFET

$Z_{thJH} = f(t)$ (typical)

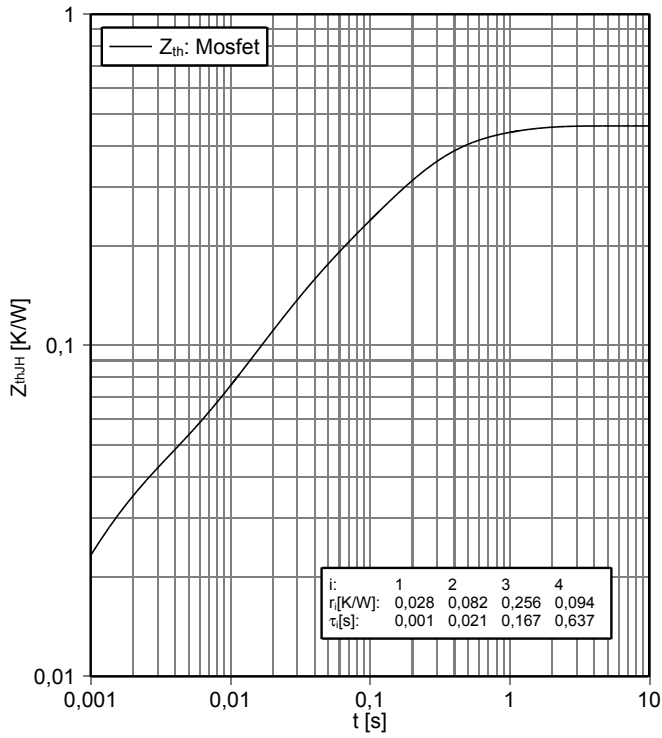

forward characteristic MOSFET body diode (typical)

$I_{SD} = f(V_{SD})$

$T_j = 25^\circ\text{C}$

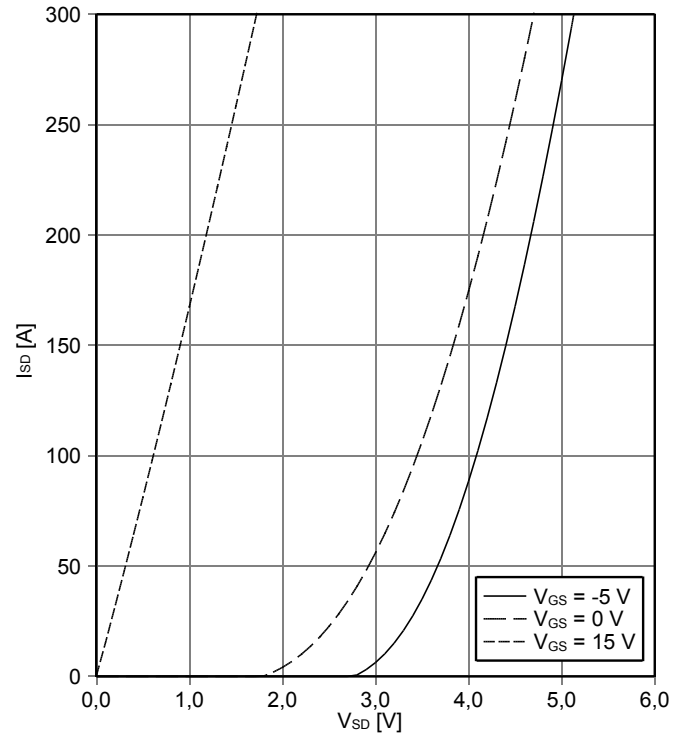

NTC-Thermistor-temperature characteristic (typical)

$R = f(T)$

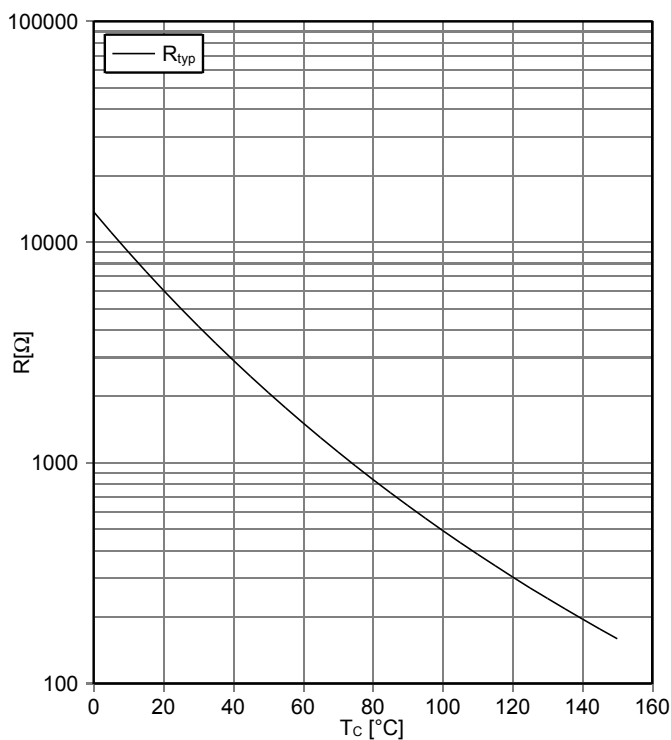

7 Circuit diagram

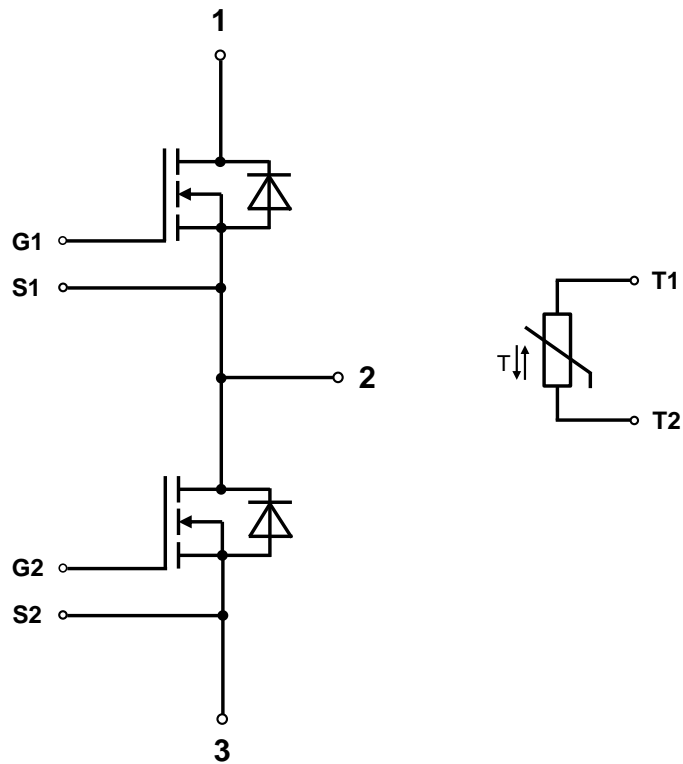

8 Package outlines

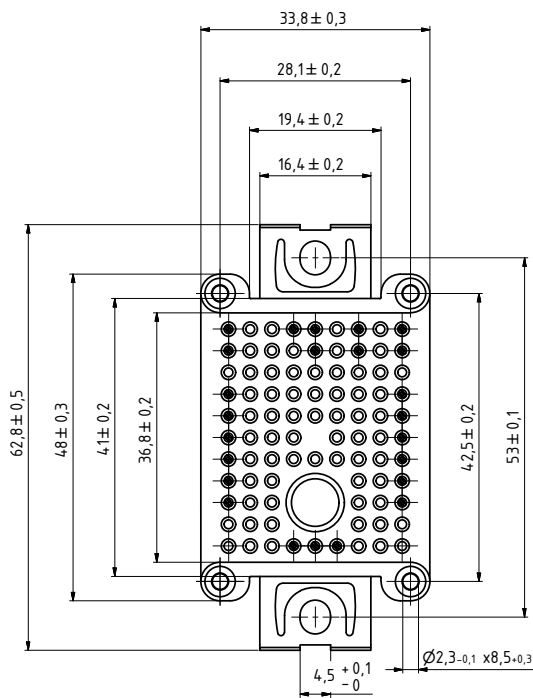
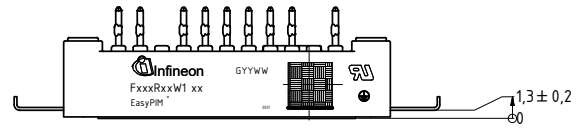
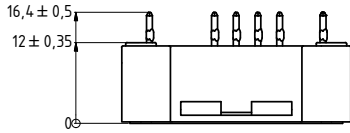

- Pin-Grid 3,2mm
- Tolerance of PCB hole pattern $\oplus 0,1$
- Hole specification for contacts see AN 2009-01
- Diameters of drill $\varnothing 1,15$ mm and copper thickness in hole 25-50 μ m

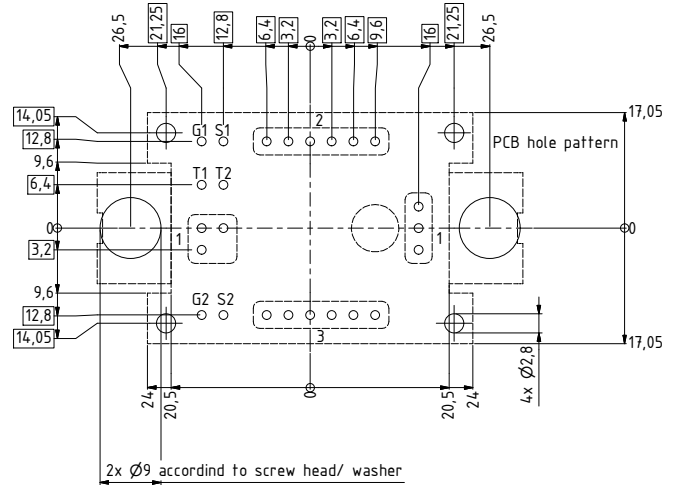

ISO 8015 principle of independency dimensions ISO 14405 \oplus target geometry according CAD file with general tolerances $\square 1$ method of least-squares	Drawing: D000135987.02		
	edges	general tolerances	surface
	DIN ISO 13715	1. DIN 16742-TG6 2. DIN ISO 2768-mk	DIN EN ISO 1302

All dimensions refer to module in delivery condition

9 Label Codes

9.1 Module Code

Code Format	Data Matrix		
Encoding	ASCII Text		
Symbol Size	16x16		
Standard	IEC24720 and IEC16022		
Code Content	Content Module Serial Number Module Material Number Production Order Number Datecode (Production Year) Datecode (Production Week)	Digit 1 - 5 6 - 11 12 - 19 20 - 21 22 - 23	Example (below) 71549 142846 55054991 15 30
Example	 71549142846550549911530		

9.2 Packing Code

Code Format	Code128			
Encoding	Code Set A			
Symbol Size	34 digits			
Standard	IEC8859-1			
Code Content	Content Backend Construction Number Production Lot Number Serial Number Date Code Box Quantity	Identifier X 1T S 9D Q	Digit 2 - 9 12 - 19 21 - 25 28 - 31 33 - 34	Example (below) 95056609 2X0003E0 754389 1139 15
Example	 X950566091T2X0003E0S754389D1139Q15			

Revision History

Major changes since previous revision

Revision History		
Reference	Date	Description
V1.0	2018-11-21	Target datasheet
V1.1	2018-11-27	Correction of pin designation in circuit diagram
V2.0	2019-08-13	Target datasheet 1.1, New data for preliminary datasheet
V3.0	2020-03-25	Final datasheet
V3.1	2020-09-15	Correction of Erec energy and du/dt value

Terms & Conditions of usage

Edition 2018-08-01

Published by
Infineon Technologies AG
81726 Munich, Germany
© 2018 Infineon Technologies AG
All Rights Reserved.

Legal Disclaimer

The information given in this document shall in no event be regarded as a guarantee of conditions or characteristics. With respect to any examples or hints given herein, any typical values stated herein and/or any information regarding the application of the device, Infineon Technologies hereby disclaims any and all warranties and liabilities of any kind, including without limitation, warranties of non-infringement of intellectual property rights of any third party.

Information

For further information on technology, delivery terms and conditions and prices, please contact the nearest Infineon Technologies Office (<http://www.infineon.com>)

Warnings

Due to technical requirements, components may contain dangerous substances. For information on the types in question, please contact the nearest Infineon Technologies Office.

These components are not designed for "special applications" that demand extremely high reliability or safety such as aerospace, defense or life support devices or systems (Class III medical devices). If you intend to use the components in any of these special applications, please contact your local representative at International Rectifier HiRel Products, Inc. or the Infineon support (<https://www.infineon.com/support>) to review product requirements and reliability testing.

Infineon Technologies components may be used in special applications only with the express written approval of Infineon Technologies. Class III medical devices are intended to be implanted in the human body or to support and/or maintain and sustain and/or protect human life. If they fail, it is reasonable to assume that the health of the user or other persons may be endangered.

Trademarks

Trademarks of Infineon Technologies AG

AURIX™, C166™, CanPAK™, CIPOS™, CIPURSE™, EconoPACK™, CoolMOS™, CoolSET™, CORECONTROL™, CROSSAVE™, DAVE™, DI-POL™, EasyPIM™, EconoBRIDGE™, EconoDUAL™, EconoPIM™, EconoPACK™, EiceDRIVER™, eupec™, FCOS™, HITFET™, HybridPACK™, I²RFT™, ISOFACE™, IsoPACK™, MIPAQ™, ModSTACK™, my-d™, NovalithIC™, OptiMOS™, ORIGA™, POWERCODE™, PRIMARION™, PrimePACK™, PrimeSTACK™, PRO-SIL™, PROFET™, RASIC™, ReverSave™, SatRIC™, SIEGET™, SINDRION™, SIPMOST™, SmartLEWIS™, SOLID FLASH™, TEMPFET™, thinQ!™, TRENCHSTOP™, TriCore™.

Other Trademarks

Advance Design System™ (ADS) of Agilent Technologies, AMBA™, ARM™, MULTI-ICE™, KEIL™, PRIMECELL™, REALVIEW™, THUMB™, μVision™ of ARM Limited, UK. AUTOSAR™ is licensed by AUTOSAR development partnership. Bluetooth™ of Bluetooth SIG Inc. CAT-iq™ of DECT Forum. COLOSSUS™, FirstGPS™ of Trimble Navigation Ltd. EMV™ of EMVCo, LLC (Visa Holdings Inc.). EPCOS™ of Epcos AG. FLEXGO™ of Microsoft Corporation. FlexRay™ is licensed by FlexRay Consortium. HYPERTERMINAL™ of Hilgraeve Incorporated. IEC™ of Commission Electrotechnique Internationale. IrDA™ of Infrared Data Association Corporation. ISO™ of INTERNATIONAL ORGANIZATION FOR STANDARDIZATION. MATLAB™ of MathWorks, Inc. MAXIM™ of Maxim Integrated Products, Inc. MICROTEC™, NUCLEUS™ of Mentor Graphics Corporation. MIPI™ of MIPI Alliance, Inc. MIPS™ of MIPS Technologies, Inc., USA. muRata™ of MURATA MANUFACTURING CO., MICROWAVE OFFICE™ (MWO) of Applied Wave Research Inc., OmniVision™ of OmniVision Technologies, Inc. Openwave™ Openwave Systems Inc. RED HAT™ Red Hat, Inc. RFMD™ RF Micro Devices, Inc. SIRIUS™ of Sirius Satellite Radio Inc. SOLARIS™ of Sun Microsystems, Inc. SPANSION™ of Spansion LLC Ltd. Symbian™ of Symbian Software Limited. TAIYO YUDEN™ of Taiyo Yuden Co. TEAKLITE™ of CEVA, Inc. TEKTRONIX™ of Tektronix Inc. TOKO™ of TOKO KABUSHIKI KAISHA TA. UNIX™ of X/Open Company Limited. VERILOG™, PALLADIUM™ of Cadence Design Systems, Inc. VLYNQ™ of Texas Instruments Incorporated. VXWORKS™, WIND RIVER™ of WIND RIVER SYSTEMS, INC. ZETEX™ of Diodes Zetex Limited.

Last update

2011-11-11

www.infineon.com

Published by Infineon Technologies AG

Downloaded From Oneyac.com

单击下面可查看定价，库存，交付和生命周期等信息

[>>Infineon\(英飞凌\)](#)