

## IGBT

High speed 5 IGBT in TRENCHSTOP™ 5 technology copacked with RAPID 1 fast and soft antiparallel diode

## IKP08N65H5

650V DuoPack IGBT and Diode  
High speed switching series fifth generation

Data sheet

Industrial Power Control

High speed 5 IGBT in TRENCHSTOP™ 5 technology copacked with RAPID 1 fast and soft antiparallel diode

**Features and Benefits:**

High speed H5 technology offering

- Best-in-Class efficiency in hard switching and resonant topologies
- Plug and play replacement of previous generation IGBTs
- 650V breakdown voltage
- Low  $Q_G$
- IGBT copacked with RAPID 1 fast and soft antiparallel diode
- Maximum junction temperature 175°C
- Qualified according to JEDEC for target applications
- Pb-free lead plating; RoHS compliant
- Complete product spectrum and PSpice Models:  
<http://www.infineon.com/igbt/>

**Applications:**

- Solar converters
- Uninterruptible power supplies
- Welding converters
- Mid to high range switching frequency converters

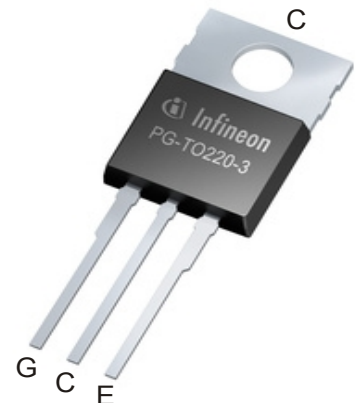
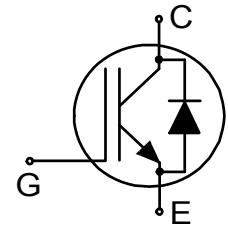

**Key Performance and Package Parameters**

| Type       | $V_{CE}$ | $I_C$ | $V_{CEsat}, T_{vj}=25^\circ C$ | $T_{vjmax}$ | Marking | Package    |
|------------|----------|-------|--------------------------------|-------------|---------|------------|
| IKP08N65H5 | 650V     | 8A    | 1.65V                          | 175°C       | K08EEH5 | PG-TO220-3 |



**Table of Contents**

Description ..... 2

Table of Contents ..... 3

Maximum Ratings ..... 4

Thermal Resistance ..... 4

Electrical Characteristics ..... 5

Electrical Characteristics Diagrams ..... 8

Package Drawing .....15

Testing Conditions .....16

Revision History .....17

Disclaimer .....17

**Maximum Ratings**

For optimum lifetime and reliability, Infineon recommends operating conditions that do not exceed 80% of the maximum ratings stated in this datasheet.

| Parameter  | Symbol      | Value                | Unit             |
|--|-------------|----------------------|------------------|
| Collector-emitter voltage  | $V_{CE}$    | 650                  | V                |
| DC collector current, limited by $T_{vjmax}$<br>$T_C = 25^\circ\text{C}$<br>$T_C = 100^\circ\text{C}$  | $I_C$       | 18.0<br>11.0         | A                |
| Pulsed collector current, $t_p$ limited by $T_{vjmax}$   | $I_{Cpuls}$ | 24.0                 | A                |
| Turn off safe operating area $V_{CE} \leq 650\text{V}$ , $T_{vj} \leq 175^\circ\text{C}$               | -           | 24.0                 | A                |
| Diode forward current, limited by $T_{vjmax}$<br>$T_C = 25^\circ\text{C}$<br>$T_C = 100^\circ\text{C}$ | $I_F$       | 20.0<br>12.0         | A                |
| Diode pulsed current, $t_p$ limited by $T_{vjmax}$   | $I_{Fpuls}$ | 24.0                 | A                |
| Gate-emitter voltage<br>Transient Gate-emitter voltage ( $t_p \leq 10\mu\text{s}$ , $D < 0.010$ )      | $V_{GE}$    | $\pm 20$<br>$\pm 30$ | V                |
| Power dissipation $T_C = 25^\circ\text{C}$<br>Power dissipation $T_C = 100^\circ\text{C}$              | $P_{tot}$   | 70.0<br>35.0         | W                |
| Operating junction temperature   | $T_{vj}$    | -40...+175           | $^\circ\text{C}$ |
| Storage temperature  | $T_{stg}$   | -55...+150           | $^\circ\text{C}$ |
| Soldering temperature,<br>wave soldering 1.6mm (0.063in.) from case for 10s                            |             | 260                  | $^\circ\text{C}$ |
| Mounting torque, M3 screw<br>Maximum of mounting processes: 3  | $M$         | 0.6                  | Nm               |

**Thermal Resistance**

| Parameter                                    | Symbol        | Conditions | Max. Value | Unit |
|--|---------------|------------|------------|------|
| <b>Characteristic</b>                        |               |            |            |      |
| IGBT thermal resistance,<br>junction - case  | $R_{th(j-c)}$ |            | 2.20       | K/W  |
| Diode thermal resistance,<br>junction - case | $R_{th(j-c)}$ |            | 2.90       | K/W  |
| Thermal resistance<br>junction - ambient     | $R_{th(j-a)}$ |            | 62         | K/W  |

**Electrical Characteristic, at  $T_{vj} = 25^{\circ}\text{C}$ , unless otherwise specified**

| Parameter                            | Symbol        | Conditions  | Value |                      |                | Unit          |
|--------------------------------------|---------------|---|-------|----------------------|----------------|---------------|
|                                      |               |   | min.  | typ.                 | max.           |               |
| <b>Static Characteristic</b>         |               |   |       |                      |                |               |
| Collector-emitter breakdown voltage  | $V_{(BR)CES}$ | $V_{GE} = 0\text{V}, I_C = 0.20\text{mA}$   | 650   | -                    | -              | V             |
| Collector-emitter saturation voltage | $V_{CEsat}$   | $V_{GE} = 15.0\text{V}, I_C = 8.0\text{A}$<br>$T_{vj} = 25^{\circ}\text{C}$<br>$T_{vj} = 125^{\circ}\text{C}$<br>$T_{vj} = 175^{\circ}\text{C}$ | -     | 1.65<br>1.85<br>1.95 | 2.10<br>-      | V             |
| Diode forward voltage                | $V_F$         | $V_{GE} = 0\text{V}, I_F = 9.0\text{A}$<br>$T_{vj} = 25^{\circ}\text{C}$<br>$T_{vj} = 125^{\circ}\text{C}$<br>$T_{vj} = 175^{\circ}\text{C}$    | -     | 1.45<br>1.40<br>1.40 | 1.80<br>-      | V             |
| Gate-emitter threshold voltage       | $V_{GE(th)}$  | $I_C = 0.08\text{mA}, V_{CE} = V_{GE}$  | 3.2   | 4.0                  | 4.8            | V             |
| Zero gate voltage collector current  | $I_{CES}$     | $V_{CE} = 650\text{V}, V_{GE} = 0\text{V}$<br>$T_{vj} = 25^{\circ}\text{C}$<br>$T_{vj} = 175^{\circ}\text{C}$                                   | -     | -                    | 40.0<br>4000.0 | $\mu\text{A}$ |
| Gate-emitter leakage current         | $I_{GES}$     | $V_{CE} = 0\text{V}, V_{GE} = 20\text{V}$   | -     | -                    | 100            | nA            |
| Transconductance                     | $g_{fs}$      | $V_{CE} = 20\text{V}, I_C = 8.0\text{A}$  | -     | 17.0                 | -              | S             |

**Electrical Characteristic, at  $T_{vj} = 25^{\circ}\text{C}$ , unless otherwise specified**

| Parameter  | Symbol    | Conditions  | Value |      |      | Unit |
|--|-----------|---|-------|------|------|------|
|  |           |   | min.  | typ. | max. |      |
| <b>Dynamic Characteristic</b>                                  |           |   |       |      |      |      |
| Input capacitance  | $C_{ies}$ | $V_{CE} = 25\text{V}, V_{GE} = 0\text{V}, f = 1\text{MHz}$          | -     | 500  | -    | pF   |
| Output capacitance   | $C_{oes}$ |   | -     | 16   | -    |      |
| Reverse transfer capacitance                                   | $C_{res}$ |   | -     | 3    | -    |      |
| Gate charge  | $Q_G$     | $V_{CC} = 520\text{V}, I_C = 8.0\text{A},$<br>$V_{GE} = 15\text{V}$ | -     | 22.0 | -    | nC   |
| Internal emitter inductance measured 5mm (0.197 in.) from case | $L_E$     |   | -     | 7.0  | -    | nH   |

**Switching Characteristic, Inductive Load**

| Parameter   | Symbol       | Conditions   | Value |      |      | Unit |
|---|--------------|--|-------|------|------|------|
|   |              |  | min.  | typ. | max. |      |
| <b>IGBT Characteristic, at <math>T_{vj} = 25^{\circ}\text{C}</math></b> |              |  |       |      |      |      |
| Turn-on delay time  | $t_{d(on)}$  | $T_{vj} = 25^{\circ}\text{C},$<br>$V_{CC} = 400\text{V}, I_C = 4.0\text{A},$<br>$V_{GE} = 0.0/15.0\text{V},$<br>$R_{G(on)} = 48.0\Omega, R_{G(off)} = 48.0\Omega,$<br>$L_{\sigma} = 30\text{nH}, C_{\sigma} = 30\text{pF}$<br>$L_{\sigma}, C_{\sigma}$ from Fig. E<br>Energy losses include "tail" and diode reverse recovery. | -     | 11   | -    | ns   |
| Rise time   | $t_r$        |  | -     | 5    | -    | ns   |
| Turn-off delay time   | $t_{d(off)}$ |  | -     | 115  | -    | ns   |
| Fall time   | $t_f$        |  | -     | 15   | -    | ns   |
| Turn-on energy  | $E_{on}$     |  | -     | 0.07 | -    | mJ   |
| Turn-off energy   | $E_{off}$    |  | -     | 0.03 | -    | mJ   |
| Total switching energy  | $E_{ts}$     |  | -     | 0.10 | -    | mJ   |

## High speed switching series fifth generation

|                        |              |  |   |      |   |    |
|------------------------|--------------|--|---|------|---|----|
| Turn-on delay time     | $t_{d(on)}$  | $T_{vj} = 25^{\circ}\text{C}$ ,<br>$V_{CC} = 400\text{V}$ , $I_C = 2.0\text{A}$ ,<br>$V_{GE} = 0.0/15.0\text{V}$ ,<br>$R_{G(on)} = 48.0\Omega$ , $R_{G(off)} = 48.0\Omega$ ,<br>$L\sigma = 30\text{nH}$ , $C\sigma = 30\text{pF}$<br>$L\sigma$ , $C\sigma$ from Fig. E<br>Energy losses include "tail" and diode reverse recovery. | - | 10   | - | ns |
| Rise time              | $t_r$        |  | - | 3    | - | ns |
| Turn-off delay time    | $t_{d(off)}$ |  | - | 125  | - | ns |
| Fall time              | $t_f$        |  | - | 30   | - | ns |
| Turn-on energy         | $E_{on}$     |  | - | 0.04 | - | mJ |
| Turn-off energy        | $E_{off}$    |  | - | 0.02 | - | mJ |
| Total switching energy | $E_{ts}$     |  | - | 0.06 | - | mJ |

**Diode Characteristic, at  $T_{vj} = 25^{\circ}\text{C}$** 

|  |              |  |   |      |   |                        |
|--|--------------|--|---|------|---|------------------------|
| Diode reverse recovery time                                      | $t_{rr}$     | $T_{vj} = 25^{\circ}\text{C}$ ,<br>$V_R = 400\text{V}$ ,<br>$I_F = 4.0\text{A}$ ,<br>$di_F/dt = 800\text{A}/\mu\text{s}$ | - | 40   | - | ns                     |
| Diode reverse recovery charge                                    | $Q_{rr}$     |  | - | 0.13 | - | $\mu\text{C}$          |
| Diode peak reverse recovery current                              | $I_{rrm}$    |  | - | 6.8  | - | A                      |
| Diode peak rate of fall of reverse recovery current during $t_b$ | $di_{rr}/dt$ |  | - | -220 | - | $\text{A}/\mu\text{s}$ |
| Diode reverse recovery time                                      | $t_{rr}$     | $T_{vj} = 25^{\circ}\text{C}$ ,<br>$V_R = 400\text{V}$ ,<br>$I_F = 2.0\text{A}$ ,<br>$di_F/dt = 800\text{A}/\mu\text{s}$ | - | 24   | - | ns                     |
| Diode reverse recovery charge                                    | $Q_{rr}$     |  | - | 0.09 | - | $\mu\text{C}$          |
| Diode peak reverse recovery current                              | $I_{rrm}$    |  | - | 6.9  | - | A                      |
| Diode peak rate of fall of reverse recovery current during $t_b$ | $di_{rr}/dt$ |  | - | -380 | - | $\text{A}/\mu\text{s}$ |

**Switching Characteristic, Inductive Load**

| Parameter | Symbol | Conditions | Value |      |      | Unit |
|-----------|--------|------------|-------|------|------|------|
|           |        |            | min.  | typ. | max. |      |

**IGBT Characteristic, at  $T_{vj} = 150^{\circ}\text{C}$** 

|                        |              |   |   |      |   |    |
|------------------------|--------------|---|---|------|---|----|
| Turn-on delay time     | $t_{d(on)}$  | $T_{vj} = 150^{\circ}\text{C}$ ,<br>$V_{CC} = 400\text{V}$ , $I_C = 4.0\text{A}$ ,<br>$V_{GE} = 0.0/15.0\text{V}$ ,<br>$R_{G(on)} = 48.0\Omega$ , $R_{G(off)} = 48.0\Omega$ ,<br>$L\sigma = 30\text{nH}$ , $C\sigma = 30\text{pF}$<br>$L\sigma$ , $C\sigma$ from Fig. E<br>Energy losses include "tail" and diode reverse recovery. | - | 10   | - | ns |
| Rise time              | $t_r$        |   | - | 6    | - | ns |
| Turn-off delay time    | $t_{d(off)}$ |   | - | 145  | - | ns |
| Fall time              | $t_f$        |   | - | 16   | - | ns |
| Turn-on energy         | $E_{on}$     |   | - | 0.11 | - | mJ |
| Turn-off energy        | $E_{off}$    |   | - | 0.05 | - | mJ |
| Total switching energy | $E_{ts}$     |   | - | 0.16 | - | mJ |
| Turn-on delay time     | $t_{d(on)}$  | $T_{vj} = 150^{\circ}\text{C}$ ,<br>$V_{CC} = 400\text{V}$ , $I_C = 2.0\text{A}$ ,<br>$V_{GE} = 0.0/15.0\text{V}$ ,<br>$R_{G(on)} = 48.0\Omega$ , $R_{G(off)} = 48.0\Omega$ ,<br>$L\sigma = 30\text{nH}$ , $C\sigma = 30\text{pF}$<br>$L\sigma$ , $C\sigma$ from Fig. E<br>Energy losses include "tail" and diode reverse recovery. | - | 10   | - | ns |
| Rise time              | $t_r$        |   | - | 4    | - | ns |
| Turn-off delay time    | $t_{d(off)}$ |   | - | 164  | - | ns |
| Fall time              | $t_f$        |   | - | 20   | - | ns |
| Turn-on energy         | $E_{on}$     |   | - | 0.06 | - | mJ |
| Turn-off energy        | $E_{off}$    |   | - | 0.03 | - | mJ |
| Total switching energy | $E_{ts}$     |   | - | 0.09 | - | mJ |

**Diode Characteristic, at  $T_{vj} = 150^{\circ}\text{C}$** 

|  |              |  |   |      |   |                        |
|--|--------------|--|---|------|---|------------------------|
| Diode reverse recovery time                                      | $t_{rr}$     | $T_{vj} = 150^{\circ}\text{C},$<br>$V_R = 400\text{V},$<br>$I_F = 4.0\text{A},$<br>$di_F/dt = 800\text{A}/\mu\text{s}$ | - | 55   | - | ns                     |
| Diode reverse recovery charge                                    | $Q_{rr}$     |  | - | 0.28 | - | $\mu\text{C}$          |
| Diode peak reverse recovery current                              | $I_{rrm}$    |  | - | 7.7  | - | A                      |
| Diode peak rate of fall of reverse recovery current during $t_b$ | $di_{rr}/dt$ |  | - | -145 | - | $\text{A}/\mu\text{s}$ |
| Diode reverse recovery time                                      | $t_{rr}$     | $T_{vj} = 150^{\circ}\text{C},$<br>$V_R = 400\text{V},$<br>$I_F = 2.0\text{A},$<br>$di_F/dt = 800\text{A}/\mu\text{s}$ | - | 42   | - | ns                     |
| Diode reverse recovery charge                                    | $Q_{rr}$     |  | - | 0.20 | - | $\mu\text{C}$          |
| Diode peak reverse recovery current                              | $I_{rrm}$    |  | - | 8.2  | - | A                      |
| Diode peak rate of fall of reverse recovery current during $t_b$ | $di_{rr}/dt$ |  | - | -220 | - | $\text{A}/\mu\text{s}$ |

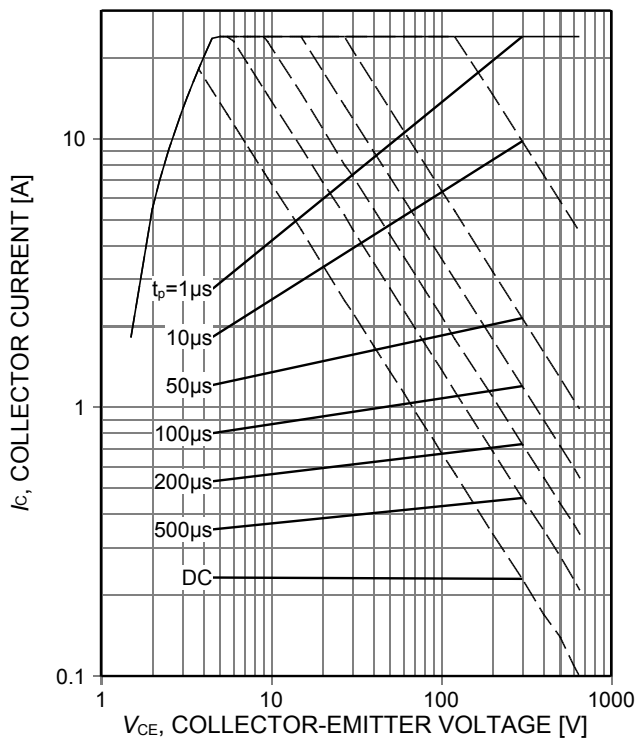

Figure 1. **Forward bias safe operating area**  
 ( $D=0$ ,  $T_C=25^\circ\text{C}$ ,  $T_{vj}\leq 175^\circ\text{C}$ ;  $V_{GE}=15\text{V}$ .  
 Recommended use at  $V_{GE}\geq 7.5\text{V}$ )

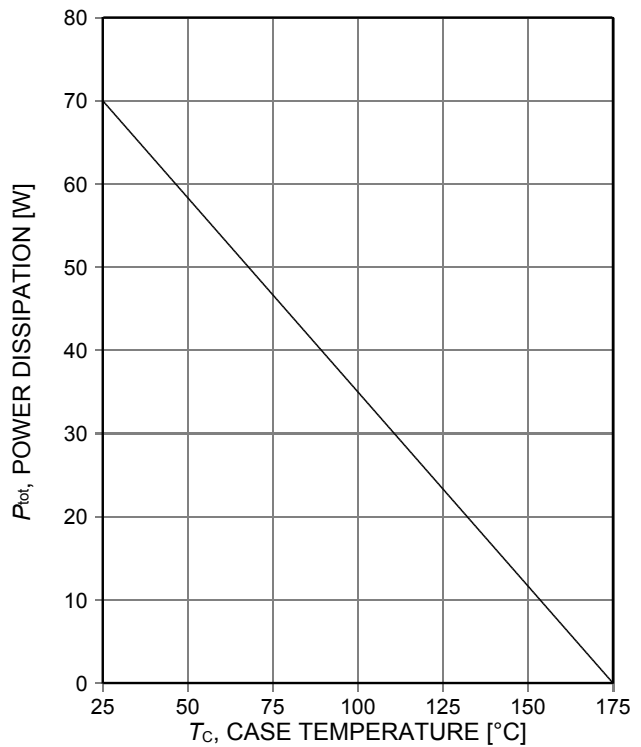

Figure 2. **Power dissipation as a function of case temperature**  
 ( $T_{vj}\leq 175^\circ\text{C}$ )

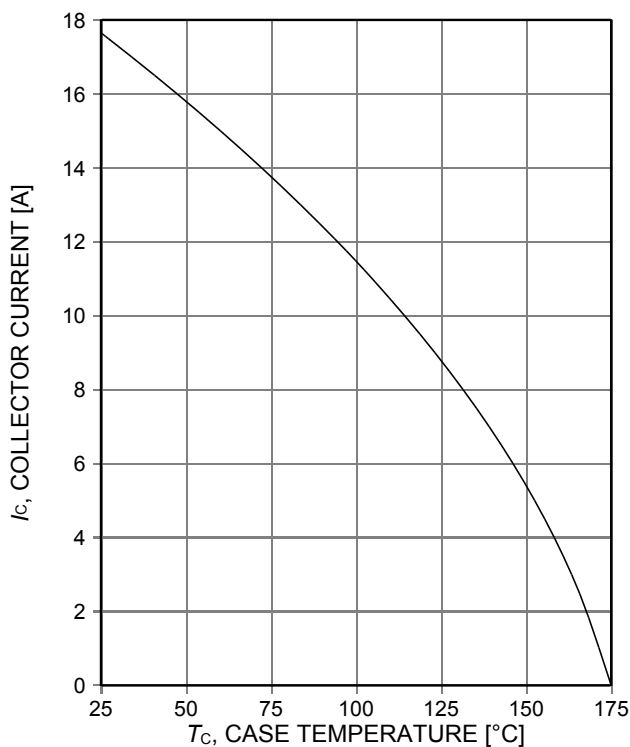

Figure 3. **Collector current as a function of case temperature**  
 ( $V_{GE}\geq 15\text{V}$ ,  $T_{vj}\leq 175^\circ\text{C}$ )

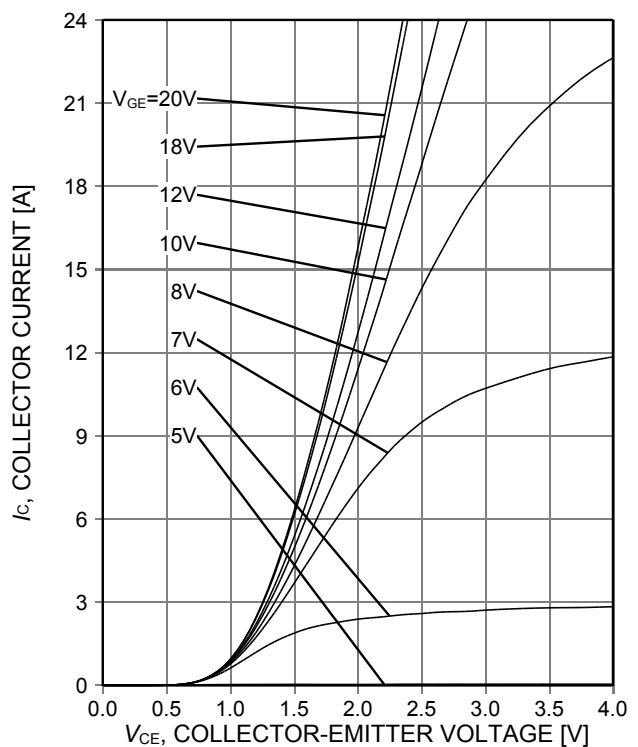

Figure 4. **Typical output characteristic**  
 ( $T_{vj}=25^\circ\text{C}$ )



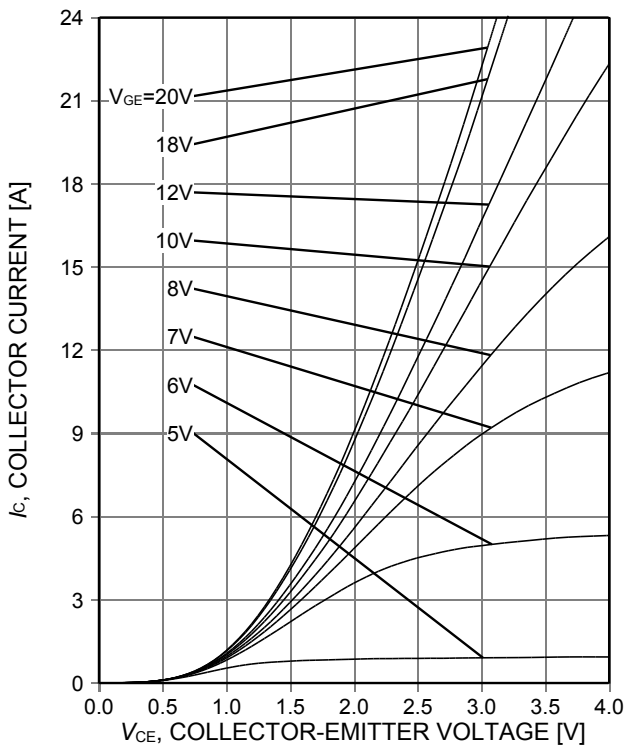

Figure 5. Typical output characteristic ( $T_{vj}=150^{\circ}\text{C}$ )

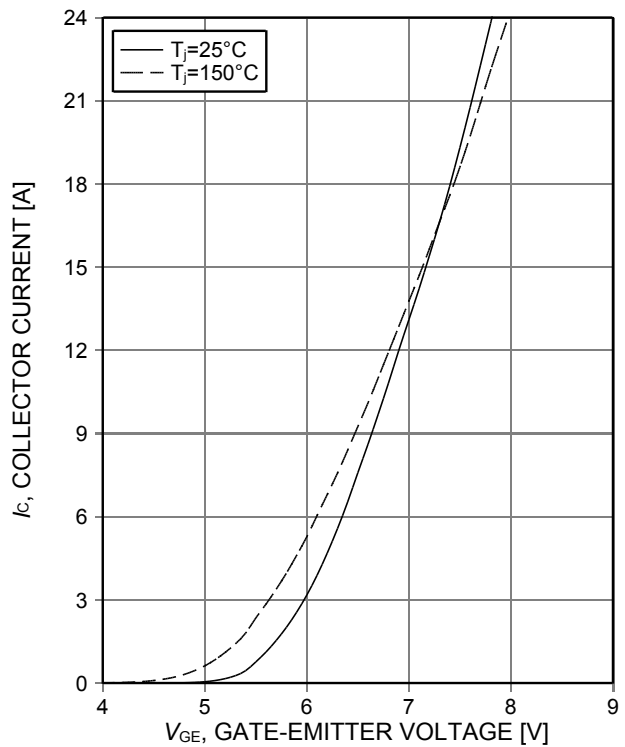

Figure 6. Typical transfer characteristic ( $V_{CE}=20\text{V}$ )

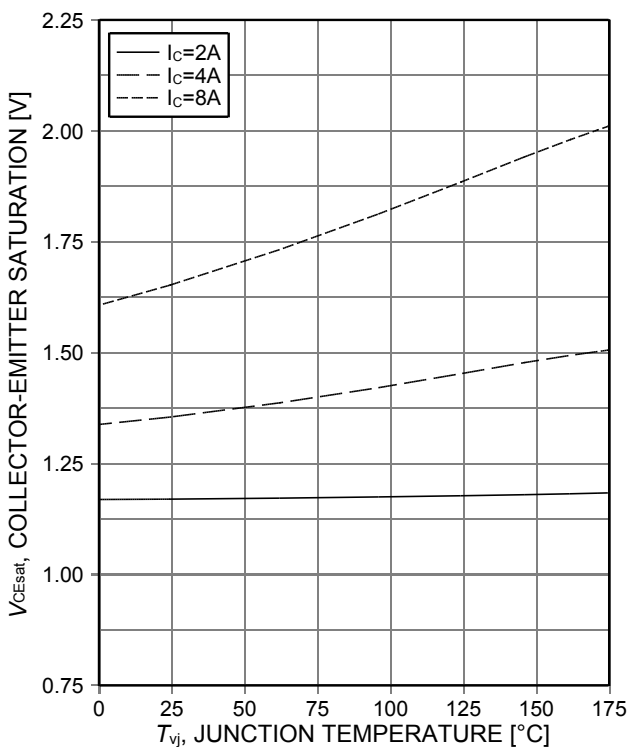

Figure 7. Typical collector-emitter saturation voltage as a function of junction temperature ( $V_{GE}=15\text{V}$ )

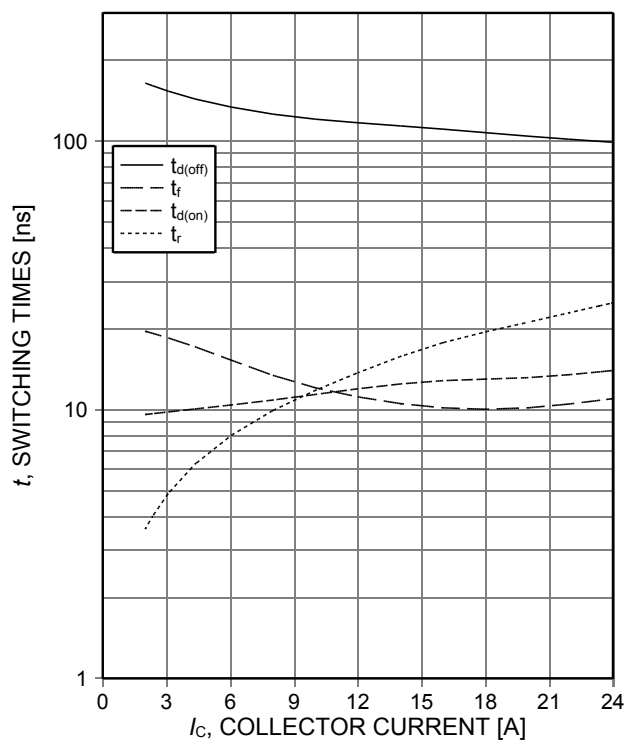

Figure 8. Typical switching times as a function of collector current (inductive load,  $T_{vj}=150^{\circ}\text{C}$ ,  $V_{CE}=400\text{V}$ ,  $V_{GE}=15/0\text{V}$ ,  $r_G=48\Omega$ , Dynamic test circuit in Figure E)

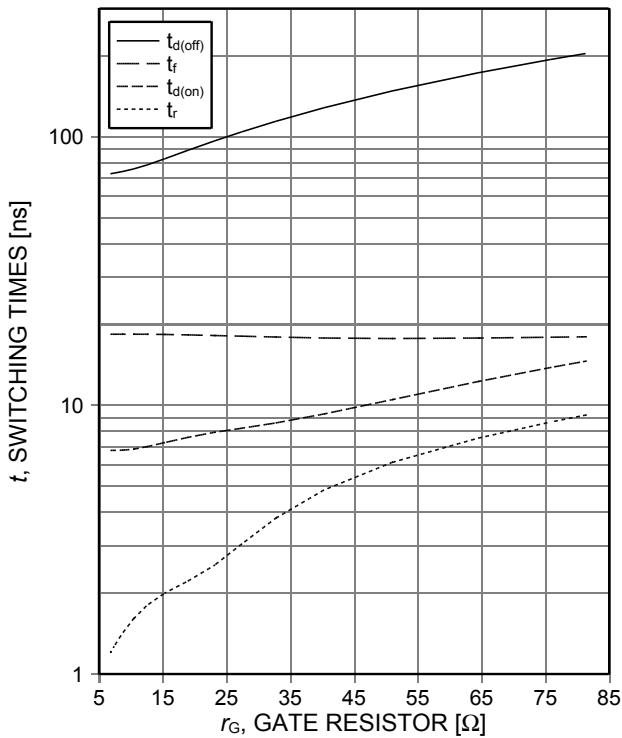

Figure 9. **Typical switching times as a function of gate resistor**  
 (inductive load,  $T_{vj}=150^{\circ}\text{C}$ ,  $V_{CE}=400\text{V}$ ,  $V_{GE}=15/0\text{V}$ ,  $I_C=4\text{A}$ , Dynamic test circuit in Figure E)

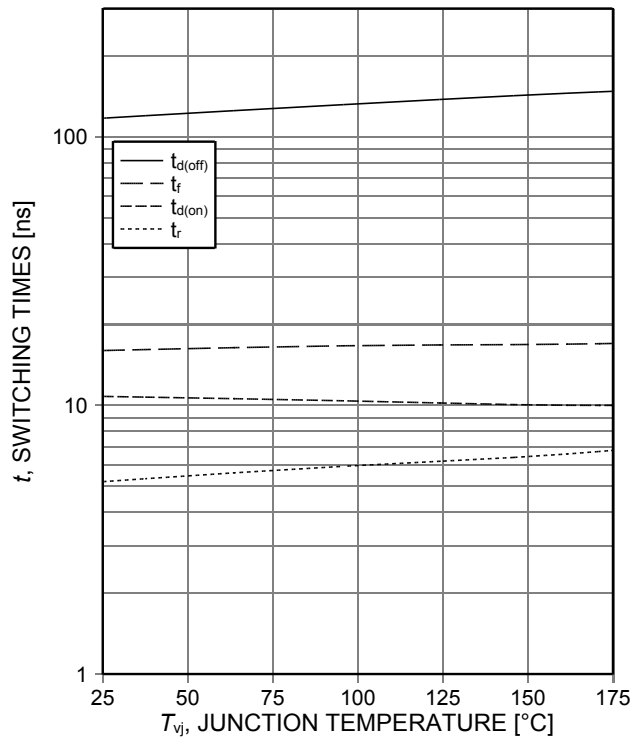

Figure 10. **Typical switching times as a function of junction temperature**  
 (inductive load,  $V_{CE}=400\text{V}$ ,  $V_{GE}=15/0\text{V}$ ,  $I_C=4\text{A}$ ,  $r_G=48\Omega$ , Dynamic test circuit in Figure E)

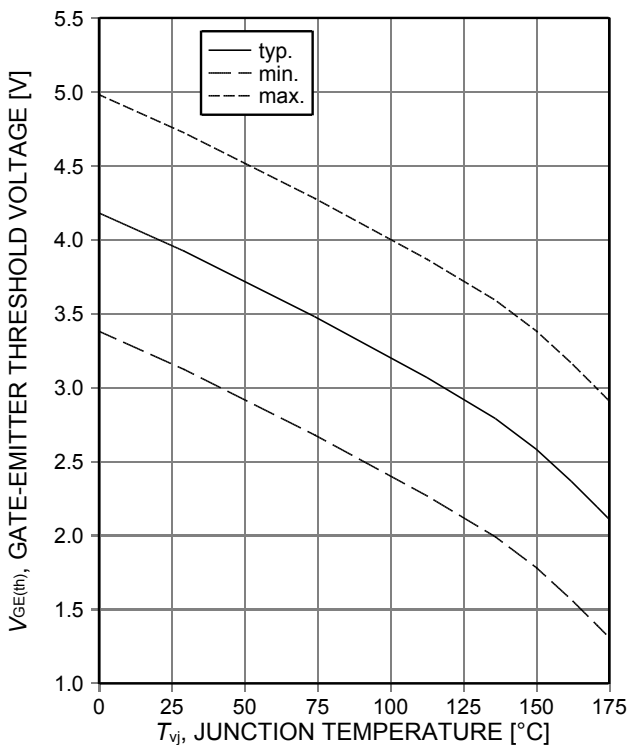

Figure 11. **Gate-emitter threshold voltage as a function of junction temperature**  
 ( $I_C=0.08\text{mA}$ )

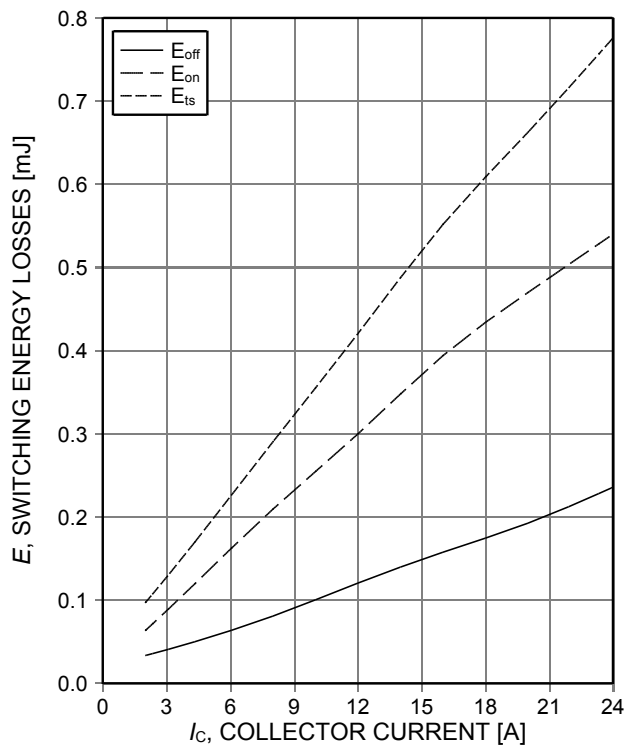

Figure 12. **Typical switching energy losses as a function of collector current**  
 (inductive load,  $T_{vj}=150^{\circ}\text{C}$ ,  $V_{CE}=400\text{V}$ ,  $V_{GE}=15/0\text{V}$ ,  $r_G=48\Omega$ , Dynamic test circuit in Figure E)



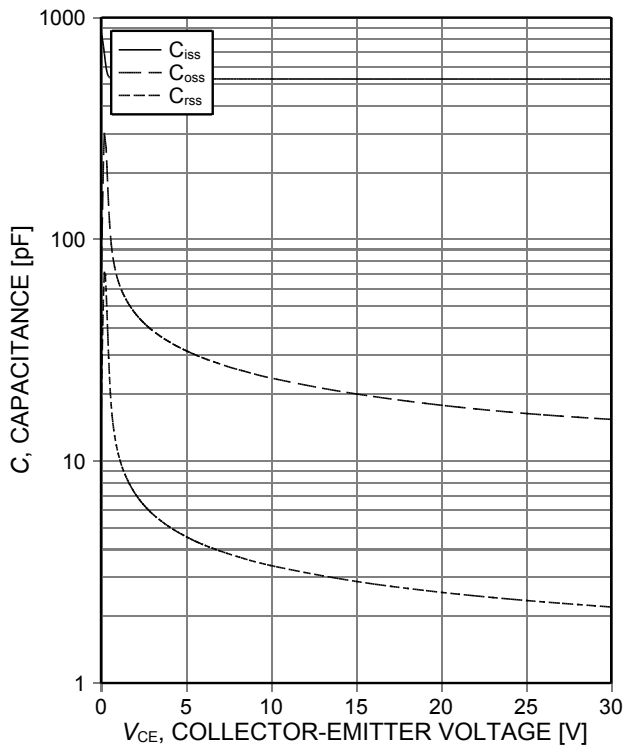

Figure 17. Typical capacitance as a function of collector-emitter voltage ( $V_{GE}=0V, f=1MHz$ )

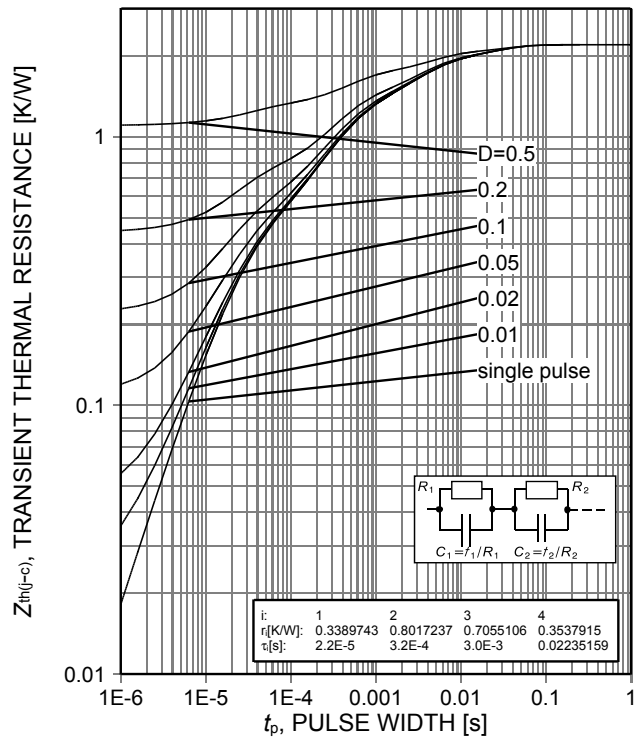

Figure 18. IGBT transient thermal resistance ( $D=t_p/T$ )

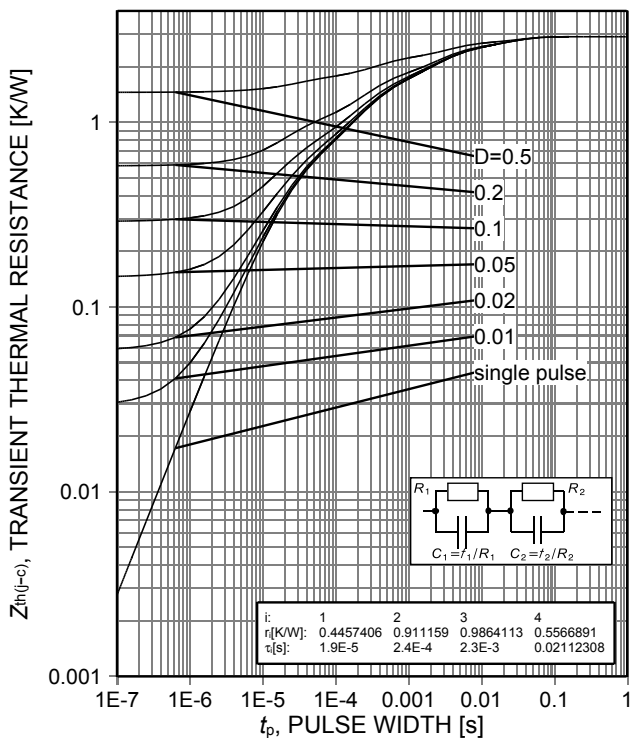

Figure 19. Diode transient thermal impedance as a function of pulse width ( $D=t_p/T$ )

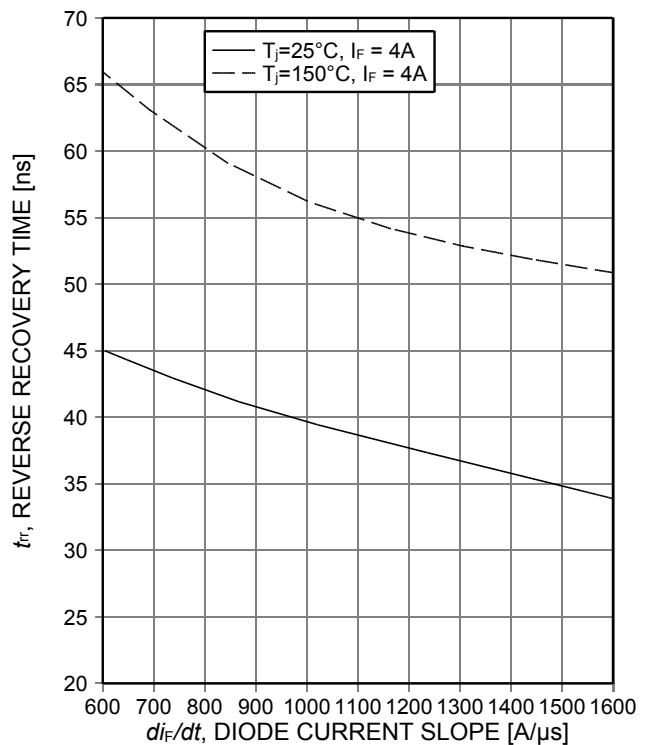

Figure 20. Typical reverse recovery time as a function of diode current slope ( $V_R=400V$ )

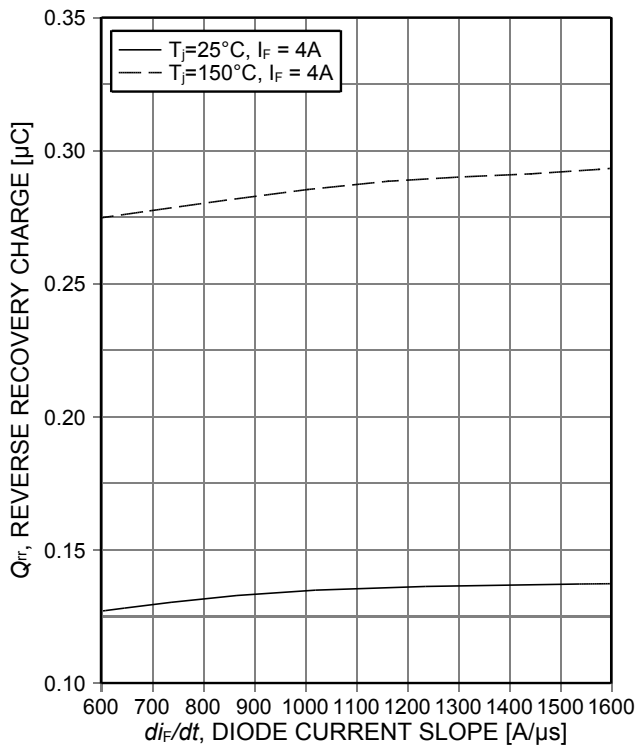

Figure 21. Typical reverse recovery charge as a function of diode current slope ( $V_R=400V$ )

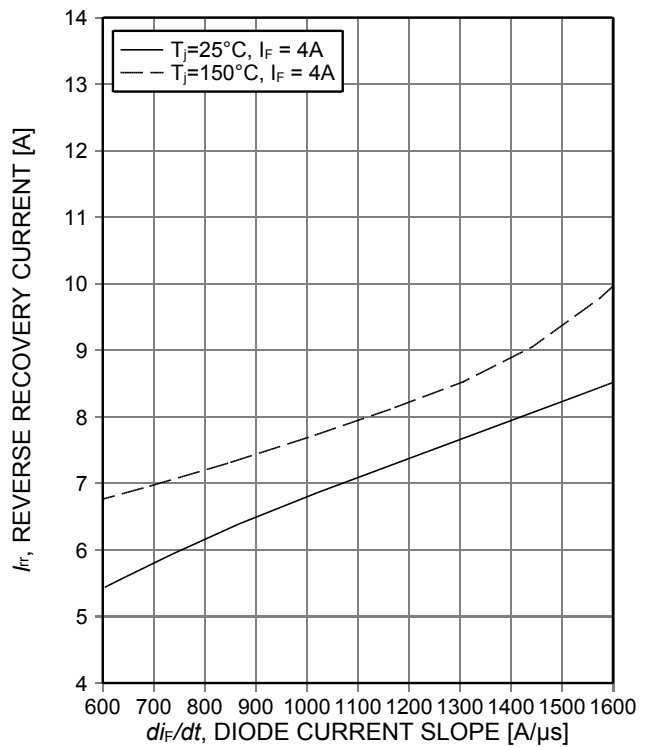

Figure 22. Typical reverse recovery current as a function of diode current slope ( $V_R=400V$ )

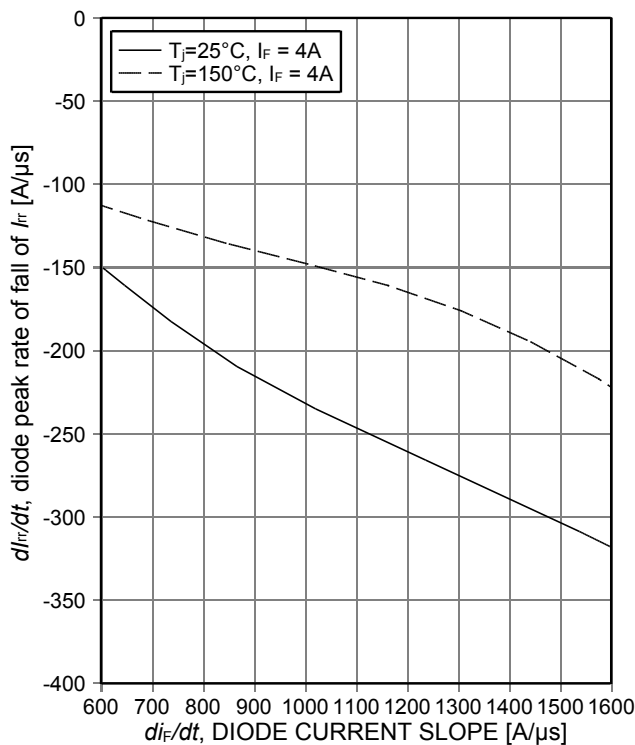

Figure 23. Typical diode peak rate of fall of reverse recovery current as a function of diode current slope ( $V_R=400V$ )

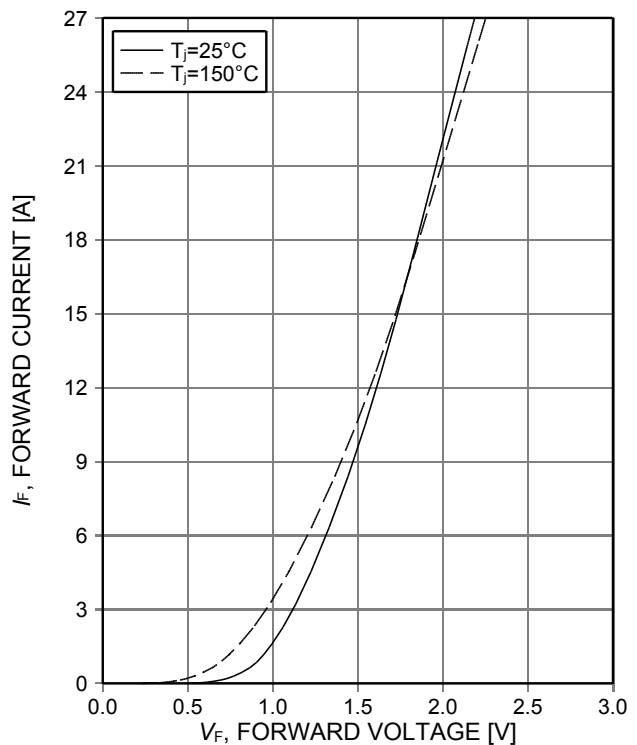

Figure 24. Typical diode forward current as a function of forward voltage

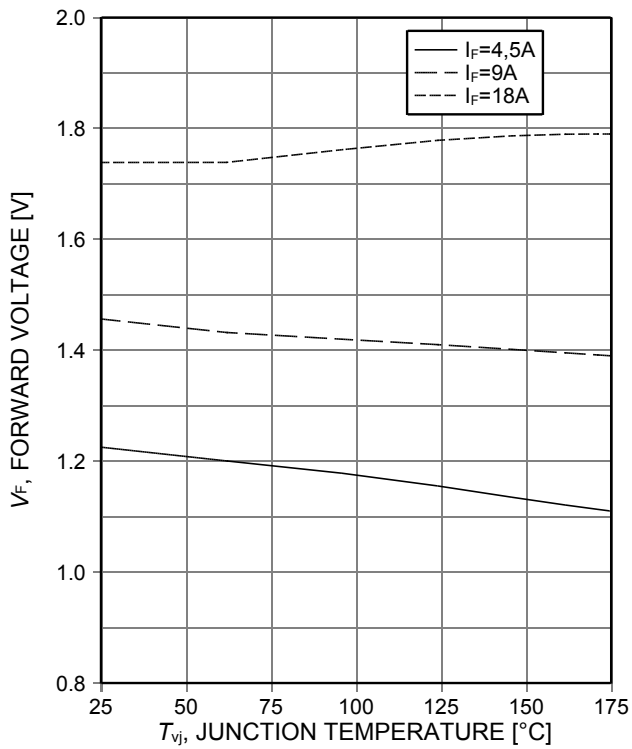
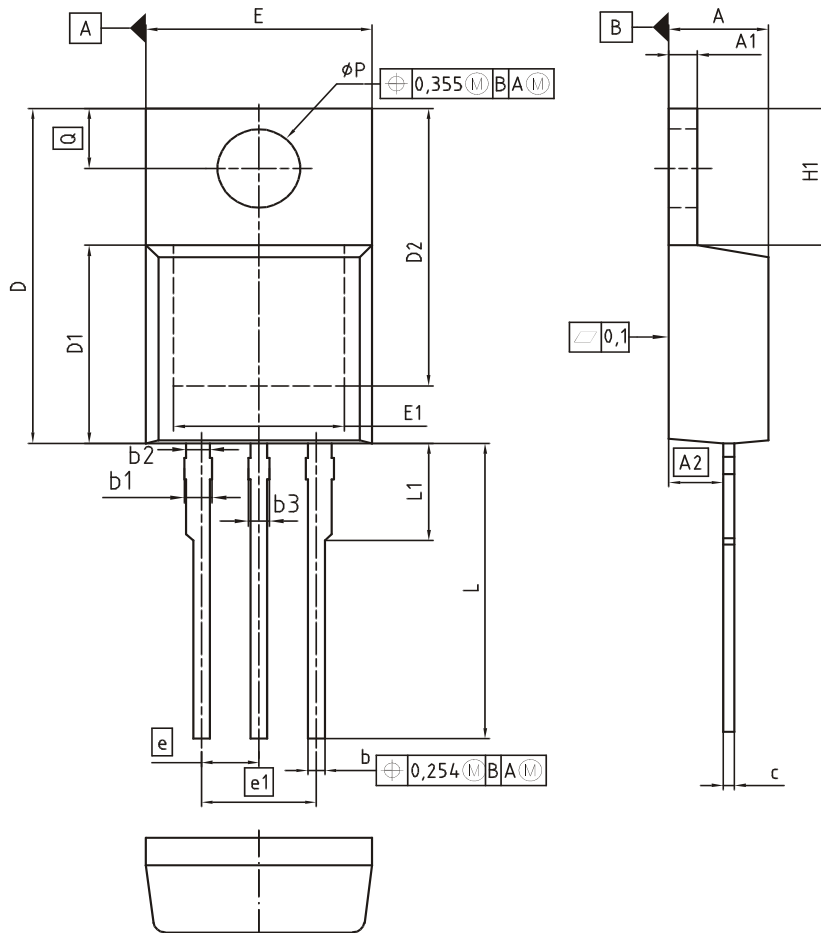

Figure 25. Typical diode forward voltage as a function of junction temperature

Package Drawing PG-TO220-3



| DIM      | MILLIMETERS |       | INCHES |       |
|----------|-------------|-------|--------|-------|
|          | MIN         | MAX   | MIN    | MAX   |
| A        | 4.30        | 4.57  | 0.169  | 0.180 |
| A1       | 1.17        | 1.40  | 0.046  | 0.055 |
| A2       | 2.15        | 2.72  | 0.085  | 0.107 |
| b        | 0.65        | 0.86  | 0.026  | 0.034 |
| b1       | 0.95        | 1.40  | 0.037  | 0.055 |
| b2       | 0.95        | 1.15  | 0.037  | 0.045 |
| b3       | 0.65        | 1.15  | 0.026  | 0.045 |
| c        | 0.33        | 0.60  | 0.013  | 0.024 |
| D        | 14.81       | 15.95 | 0.583  | 0.628 |
| D1       | 8.51        | 9.45  | 0.335  | 0.372 |
| D2       | 12.19       | 13.10 | 0.480  | 0.516 |
| E        | 9.70        | 10.36 | 0.382  | 0.408 |
| E1       | 6.50        | 8.60  | 0.256  | 0.339 |
| e        | 2.54        |       | 0.100  |       |
| e1       | 5.08        |       | 0.200  |       |
| N        | 3           |       | 3      |       |
| H1       | 5.90        | 6.90  | 0.232  | 0.272 |
| L        | 13.00       | 14.00 | 0.512  | 0.551 |
| L1       | -           | 4.80  | -      | 0.189 |
| $\phi P$ | 3.60        | 3.89  | 0.142  | 0.153 |
| Q        | 2.60        | 3.00  | 0.102  | 0.118 |

DOCUMENT NO.  
Z8B00003318

SCALE

EUROPEAN PROJECTION

ISSUE DATE  
30-07-2009

REVISION  
06

Testing Conditions

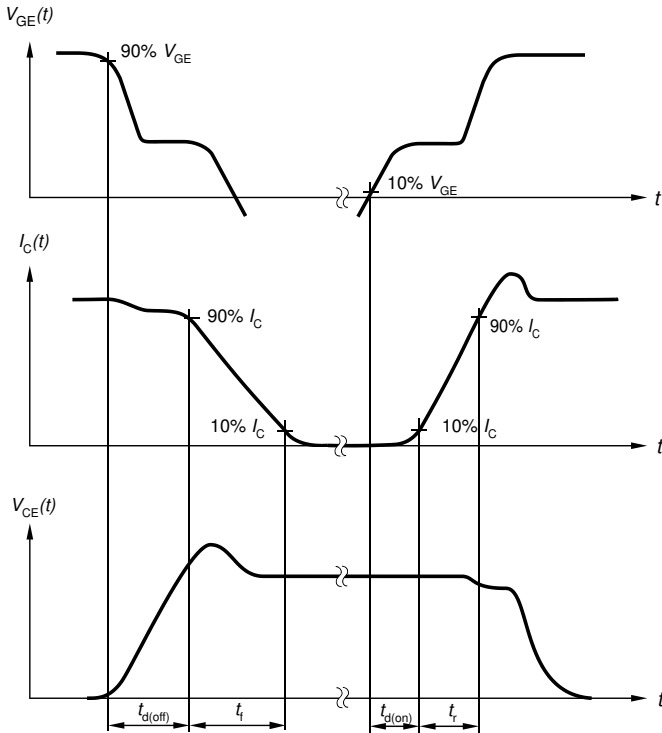

Figure A. Definition of switching times

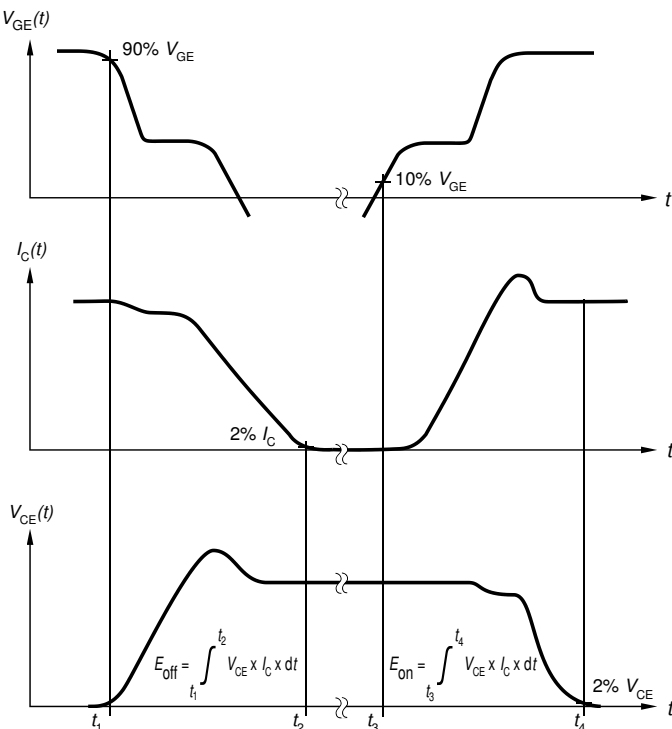

Figure B. Definition of switching losses

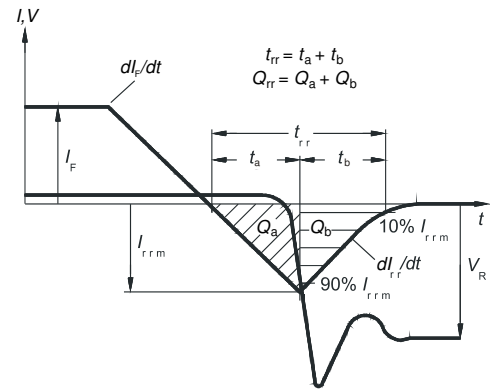

Figure C. Definition of diode switching characteristics

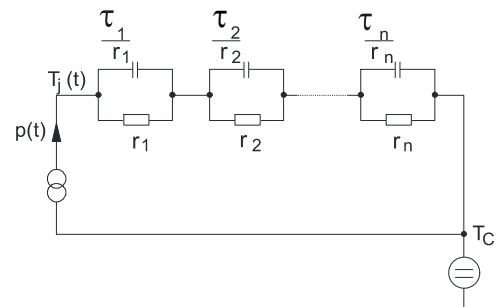

Figure D. Thermal equivalent circuit

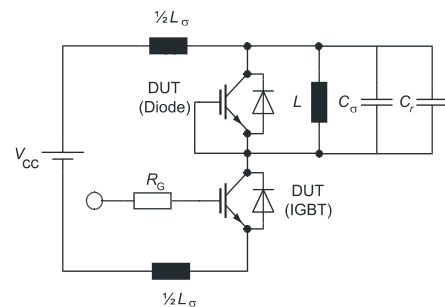

Figure E. Dynamic test circuit  
Parasitic inductance  $L_\sigma$ ,  
parasitic capacitor  $C_\sigma$ ,  
relief capacitor  $C_r$ ,  
(only for ZVT switching)



**Revision History**

IKP08N65H5

**Revision: 2015-05-05, Rev. 2.1**

## Previous Revision

| Revision | Date       | Subjects (major changes since last revision) |
|----------|------------|--|
| 1.1      | 2012-11-09 | Preliminary data sheet                       |
| 1.2      | 2013-12-17 | New Marking Pattern                          |
| 2.1      | 2015-05-05 | Final data sheet                             |

**We Listen to Your Comments**

Any information within this document that you feel is wrong, unclear or missing at all?

Your feedback will help us to continuously improve the quality of this document.

Please send your proposal (including a reference to this document) to: [erratum@infineon.com](mailto:erratum@infineon.com)

**Published by****Infineon Technologies AG****81726 Munich, Germany****81726 München, Germany****© 2015 Infineon Technologies AG****All Rights Reserved.****Legal Disclaimer**

The information given in this document shall in no event be regarded as a guarantee of conditions or characteristics.

With respect to any examples or hints given herein, any typical values stated herein and/or any information regarding the application of the device, Infineon Technologies hereby disclaims any and all warranties and liabilities of any kind, including without limitation, warranties of non-infringement of intellectual property rights of any third party.

**Information**

For further information on technology, delivery terms and conditions and prices, please contact the nearest Infineon Technologies Office ([www.infineon.com](http://www.infineon.com)).

**Warnings**

Due to technical requirements, components may contain dangerous substances. For information on the types in question, please contact the nearest Infineon Technologies Office.

The Infineon Technologies component described in this Data Sheet may be used in life-support devices or systems and/or automotive, aviation and aerospace applications or systems only with the express written approval of Infineon Technologies, if a failure of such components can reasonably be expected to cause the failure of that life-support, automotive, aviation and aerospace device or system or to affect the safety or effectiveness of that device or system. Life support devices or systems are intended to be implanted in the human body or to support and/or maintain and sustain and/or protect human life. If they fail, it is reasonable to assume that the health of the user or other persons may be endangered.

单击下面可查看定价，库存，交付和生命周期等信息

[>>Infineon\(英飞凌\)](#)