

IGBT

IGBT with integrated diode in packages offering space saving advantage

IKD03N60RF

TRENCHSTOP™ RC-Series for hard switching applications up to 30 kHz

Data sheet

Industrial Power Control

TRENCHSTOP™ RC-Drives Fast Series

IGBT with integrated diode in packages offering space saving advantage

Features:

TRENCHSTOP™ Reverse Conducting (RC) technology for 600V applications offering

- Optimized Eon, Eoff and Qrr for low switching losses
- Operating range of 4 to 30kHz
- Smooth switching performance leading to low EMI levels
- Very tight parameter distribution
- Maximum junction temperature 175°C
- Short circuit capability of 5µs
- Best in class current versus package size performance
- Qualified according to JEDEC for target applications
- Pb-free lead plating; RoHS compliant (solder temperature 260°C, MSL1)

Complete product spectrum and PSpice Models:
<http://www.infineon.com/igbt/>

Applications:

Domestic and industrial drives:

- Compressors
- Pumps
- Fans

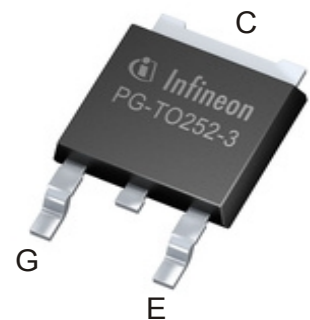
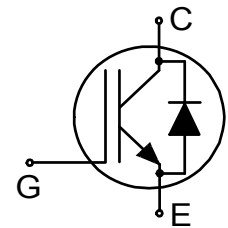

Key Performance and Package Parameters

Type	V _{CE}	I _C	V _{CEsat} , T _{vj} =25°C	T _{vjmax}	Marking	Package
IKD03N60RF	600V	2.5A	2.2V	175°C	K03R60F	PG-TO252-3

Table of Contents

Description	2
Table of Contents	3
Maximum Ratings	4
Thermal Resistance	4
Electrical Characteristics	5
Electrical Characteristics Diagrams	7
Package Drawing	14
Testing Conditions	15
Revision History	16
Disclaimer	17

TRENCHSTOP™ RC-Drives Fast Series

Maximum Ratings

For optimum lifetime and reliability, Infineon recommends operating conditions that do not exceed 80% of the maximum ratings stated in this datasheet.

Parameter	Symbol	Value	Unit
Collector-emitter voltage, $T_{vj} \geq 25^{\circ}\text{C}$	V_{CE}	600	V
DC collector current, limited by T_{vjmax} $T_c = 25^{\circ}\text{C}$ value limited by bondwire $T_c = 100^{\circ}\text{C}$	I_C	6.5 6.0	A
Pulsed collector current, t_p limited by T_{vjmax}	I_{Cpuls}	7.5	A
Turn off safe operating area $V_{CE} \leq 600\text{V}$, $T_{vj} \leq 175^{\circ}\text{C}$, $t_p = 1\mu\text{s}$	-	7.5	A
Diode forward current, limited by T_{vjmax} $T_c = 25^{\circ}\text{C}$ $T_c = 100^{\circ}\text{C}$	I_F	6.3 3.9	A
Diode pulsed current, t_p limited by T_{vjmax}	I_{Fpuls}	7.5	A
Gate-emitter voltage	V_{GE}	± 20	V
Short circuit withstand time $V_{GE} = 15.0\text{V}$, $V_{CC} \leq 400\text{V}$ Allowed number of short circuits < 1000 Time between short circuits: $\geq 1.0\text{s}$ $T_{vj} = 150^{\circ}\text{C}$	t_{SC}	5	μs
Power dissipation $T_c = 25^{\circ}\text{C}$	P_{tot}	53.6	W
Operating junction temperature	T_{vj}	-40...+175	$^{\circ}\text{C}$
Storage temperature	T_{stg}	-55...+150	$^{\circ}\text{C}$
Soldering temperature, reflow soldering (MSL1 according to JEDEC J-STA-020)		260	$^{\circ}\text{C}$

Thermal Resistance

Parameter	Symbol	Conditions	Value			Unit
			min.	typ.	max.	
R_{th} Characteristics						
IGBT thermal resistance, ¹⁾ junction - case	$R_{th(j-c)}$		-	-	2.80	K/W
Diode thermal resistance, ²⁾ junction - case	$R_{th(j-c)}$		-	-	6.80	K/W
Thermal resistance, min. footprint junction - ambient	$R_{th(j-a)}$		-	-	75	K/W
Thermal resistance, 6cm ² Cu on PCB junction - ambient	$R_{th(j-a)}$		-	-	50	K/W

¹⁾ R_{th}/Z_{th} based on single cooling pulse. Please be aware that a correct R_{th} measurement of the IGBT, is not possible using a thermocouple.

²⁾ R_{th}/Z_{th} based on single cooling pulse. Please be aware that a correct R_{th} measurement of the Diode, is not possible using a thermocouple.

TRENCHSTOP™ RC-Drives Fast Series

Electrical Characteristic, at $T_{vj} = 25^{\circ}\text{C}$, unless otherwise specified

Parameter	Symbol	Conditions	Value			Unit
			min.	typ.	max.	
Static Characteristic						
Collector-emitter breakdown voltage	$V_{(BR)CES}$	$V_{GE} = 0\text{V}, I_C = 0.20\text{mA}$	600	-	-	V
Collector-emitter saturation voltage	V_{CEsat}	$V_{GE} = 15.0\text{V}, I_C = 2.5\text{A}$ $T_{vj} = 25^{\circ}\text{C}$ $T_{vj} = 175^{\circ}\text{C}$	- -	2.20 2.30	2.50 -	V
Diode forward voltage	V_F	$V_{GE} = 0\text{V}, I_F = 2.5\text{A}$ $T_{vj} = 25^{\circ}\text{C}$ $T_{vj} = 175^{\circ}\text{C}$	- -	2.10 2.00	2.40 -	V
Gate-emitter threshold voltage	$V_{GE(th)}$	$I_C = 0.05\text{mA}, V_{CE} = V_{GE}$	4.3	5.0	5.7	V
Zero gate voltage collector current ¹⁾	I_{CES}	$V_{CE} = 600\text{V}, V_{GE} = 0\text{V}$ $T_{vj} = 25^{\circ}\text{C}$ $T_{vj} = 175^{\circ}\text{C}$	- -	- -	40 1000	μA
Gate-emitter leakage current	I_{GES}	$V_{CE} = 0\text{V}, V_{GE} = 20\text{V}$	-	-	100	nA
Transconductance	g_{fs}	$V_{CE} = 20\text{V}, I_C = 2.5\text{A}$	-	1.3	-	S
Integrated gate resistor	r_G			none		Ω

Electrical Characteristic, at $T_{vj} = 25^{\circ}\text{C}$, unless otherwise specified

Parameter	Symbol	Conditions	Value			Unit
			min.	typ.	max.	
Dynamic Characteristic						
Input capacitance	C_{ies}	$V_{CE} = 25\text{V}, V_{GE} = 0\text{V}, f = 1\text{MHz}$	-	200	-	pF
Output capacitance	C_{oes}		-	13	-	
Reverse transfer capacitance	C_{res}		-	7	-	
Gate charge	Q_G	$V_{CC} = 480\text{V}, I_C = 2.5\text{A},$ $V_{GE} = 15\text{V}$	-	17.1	-	nC
Internal emitter inductance measured 5mm (0.197 in.) from case	L_E		-	7.0	-	nH
Short circuit collector current Max. 1000 short circuits Time between short circuits: $\geq 1.0\text{s}$	$I_{C(SC)}$	$V_{GE} = 15.0\text{V}, V_{CC} \leq 400\text{V},$ $t_{SC} \leq 5\mu\text{s}$ $T_{vj} = 25^{\circ}\text{C}$	-	23	-	A

Switching Characteristic, Inductive Load

Parameter	Symbol	Conditions	Value			Unit
			min.	typ.	max.	
IGBT Characteristic, at $T_{vj} = 25^{\circ}\text{C}$						
Turn-on delay time	$t_{d(on)}$	$T_{vj} = 25^{\circ}\text{C},$ $V_{CC} = 400\text{V}, I_C = 2.5\text{A},$ $V_{GE} = 0.0/15.0\text{V},$ $R_{G(on)} = 68.0\Omega, R_{G(off)} = 68.0\Omega,$ $L_{\sigma} = 60\text{nH}, C_{\sigma} = 40\text{pF}$ L_{σ}, C_{σ} from Fig. E	-	10	-	ns
Rise time	t_r		-	8	-	ns
Turn-off delay time	$t_{d(off)}$		-	128	-	ns
Fall time	t_f		-	93	-	ns
Turn-on energy	E_{on}		-	0.05	-	mJ
Turn-off energy	E_{off}		-	0.04	-	mJ
Total switching energy	E_{ts}		-	0.09	-	mJ

¹⁾ Not subject to production test - verified by design/characterization

TRENCHSTOP™ RC-Drives Fast Series

Diode Characteristic, at $T_{vj} = 25^{\circ}\text{C}$

Diode reverse recovery time	t_{rr}	$T_{vj} = 25^{\circ}\text{C},$ $V_R = 400\text{V},$ $I_F = 2.5\text{A},$ $di_F/dt = 470\text{A}/\mu\text{s}$	-	31	-	ns
Diode reverse recovery charge	Q_{rr}		-	0.06	-	μC
Diode peak reverse recovery current	I_{rrm}		-	3.8	-	A
Diode peak rate of fall of reverse recovery current during t_b	di_{rr}/dt		-	-196	-	$\text{A}/\mu\text{s}$

Switching Characteristic, Inductive Load

Parameter	Symbol	Conditions	Value			Unit
			min.	typ.	max.	

IGBT Characteristic, at $T_{vj} = 175^{\circ}\text{C}$

Turn-on delay time	$t_{d(on)}$	$T_{vj} = 175^{\circ}\text{C},$ $V_{CC} = 400\text{V}, I_C = 2.5\text{A},$ $V_{GE} = 0.0/15.0\text{V},$ $R_{G(on)} = 68.0\Omega, R_{G(off)} = 68.0\Omega,$ $L\sigma = 60\text{nH}, C\sigma = 40\text{pF}$ $L\sigma, C\sigma$ from Fig. E	-	9	-	ns
Rise time	t_r		-	9	-	ns
Turn-off delay time	$t_{d(off)}$		-	142	-	ns
Fall time	t_f		-	123	-	ns
Turn-on energy	E_{on}		-	0.08	-	mJ
Turn-off energy	E_{off}		-	0.06	-	mJ
Total switching energy	E_{ts}		-	0.14	-	mJ

Diode Characteristic, at $T_{vj} = 175^{\circ}\text{C}$

Diode reverse recovery time	t_{rr}	$T_{vj} = 175^{\circ}\text{C},$ $V_R = 400\text{V},$ $I_F = 2.5\text{A},$ $di_F/dt = 470\text{A}/\mu\text{s}$	-	66	-	ns
Diode reverse recovery charge	Q_{rr}		-	0.19	-	μC
Diode peak reverse recovery current	I_{rrm}		-	6.2	-	A
Diode peak rate of fall of reverse recovery current during t_b	di_{rr}/dt		-	-125	-	$\text{A}/\mu\text{s}$

TRENCHSTOP™ RC-Drives Fast Series

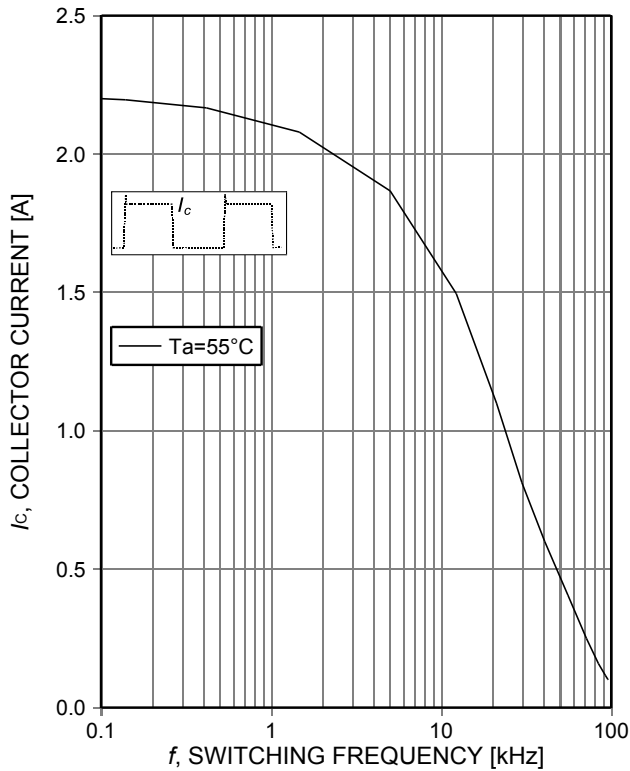

Figure 1. **Collector current as a function of switching frequency**
 ($T_{vj} \leq 175^\circ\text{C}$, $T_a = 55^\circ\text{C}$, $D = 0.5$, $V_{CE} = 400\text{V}$,
 $V_{GE} = 0/15\text{V}$, $R_G = 68\Omega$, PCB mounting, 6cm² Cu, Ptot=2,4W)

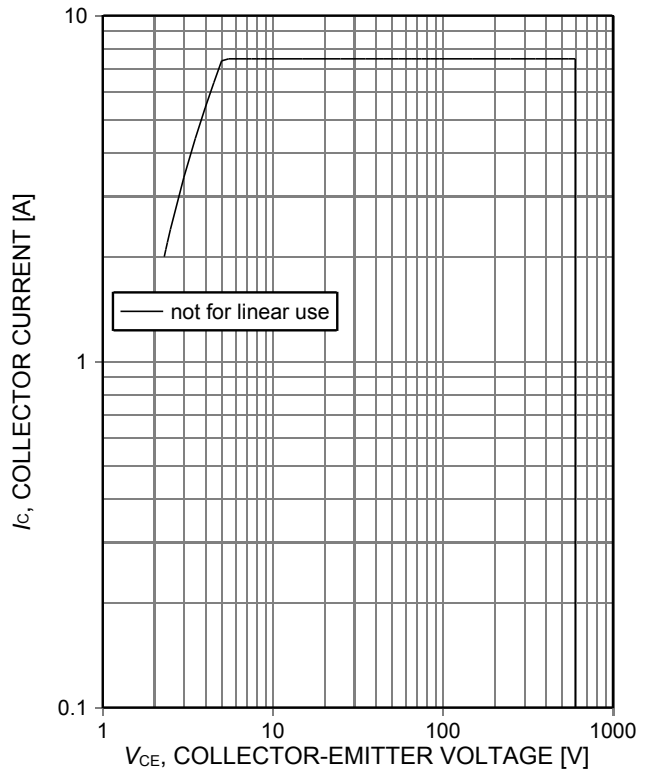

Figure 2. **Forward bias safe operating area**
 ($D = 0$, $T_C = 25^\circ\text{C}$, $T_{vj} \leq 175^\circ\text{C}$; $V_{GE} = 15\text{V}$)

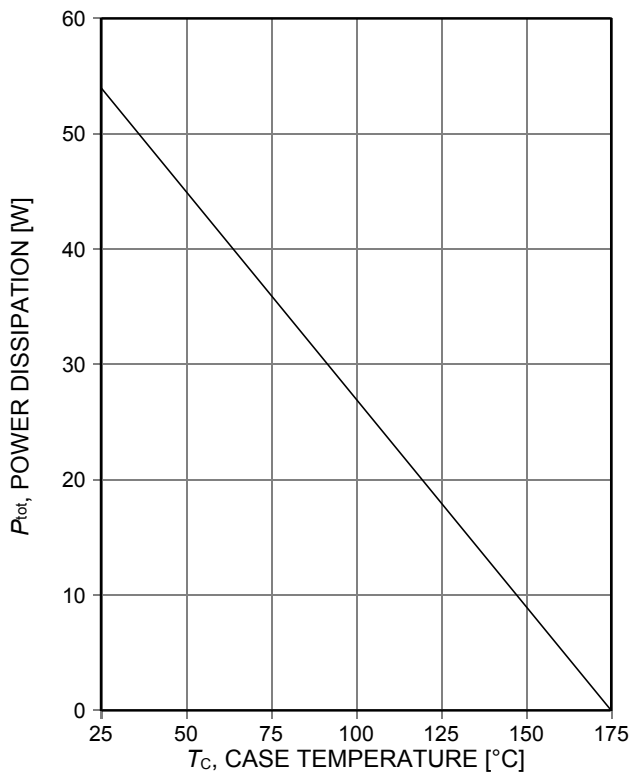

Figure 3. **Power dissipation as a function of case temperature**
 ($T_{vj} \leq 175^\circ\text{C}$)

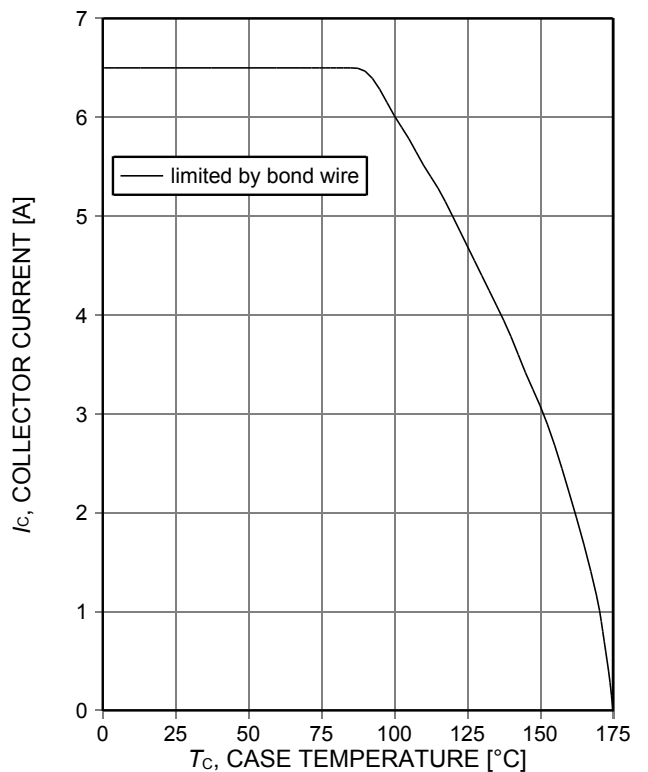

Figure 4. **Collector current as a function of case temperature**
 ($V_{GE} \geq 15\text{V}$, $T_{vj} \leq 175^\circ\text{C}$)

TRENCHSTOP™ RC-Drives Fast Series

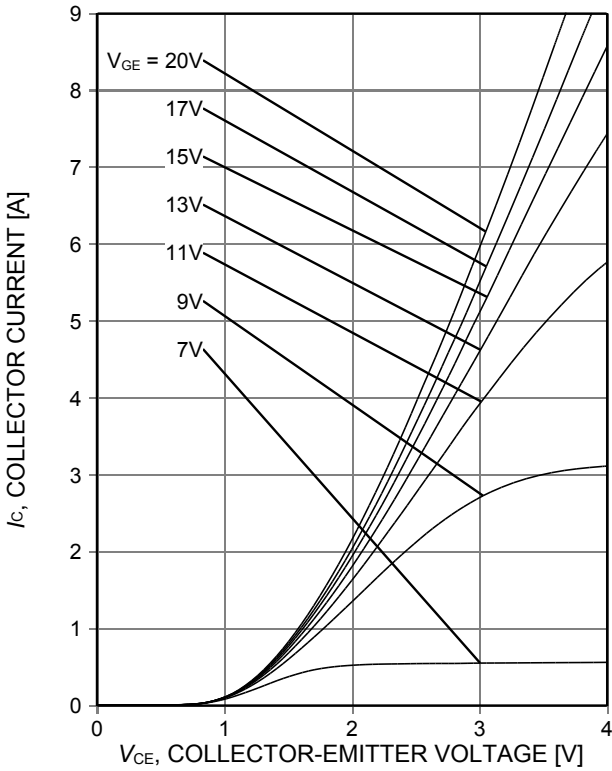

Figure 5. **Typical output characteristic**
($T_{vj}=25^{\circ}\text{C}$)

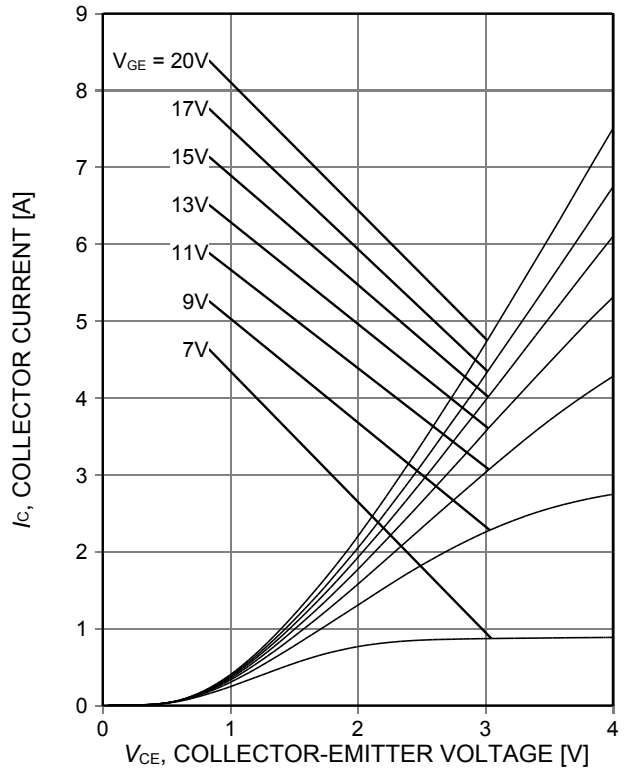

Figure 6. **Typical output characteristic**
($T_{vj}=175^{\circ}\text{C}$)

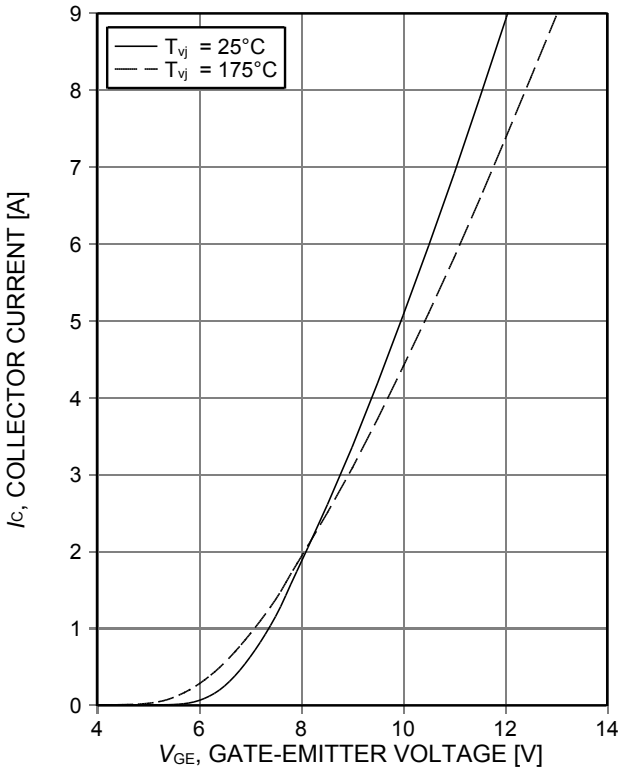

Figure 7. **Typical transfer characteristic**
($V_{ce}=10\text{V}$)

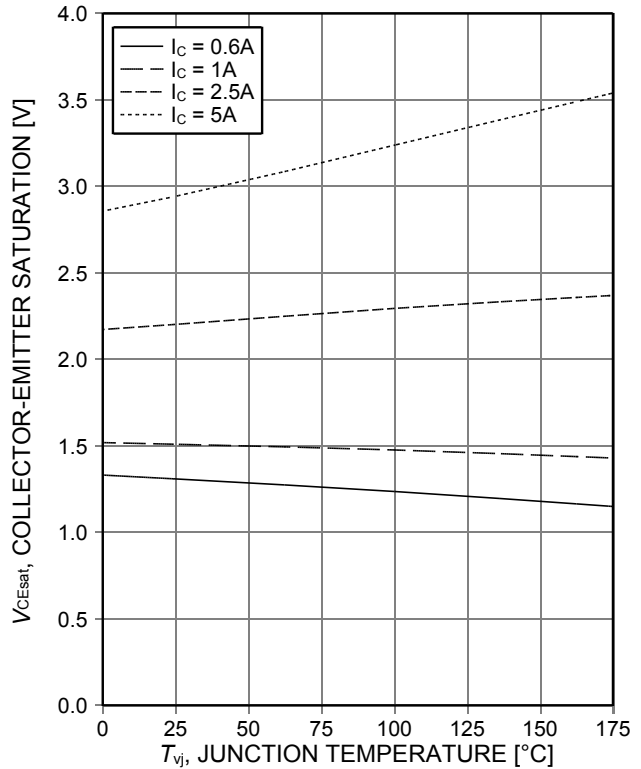

Figure 8. **Typical collector-emitter saturation voltage as a function of junction temperature**
($V_{ge}=15\text{V}$)

TRENCHSTOP™ RC-Drives Fast Series

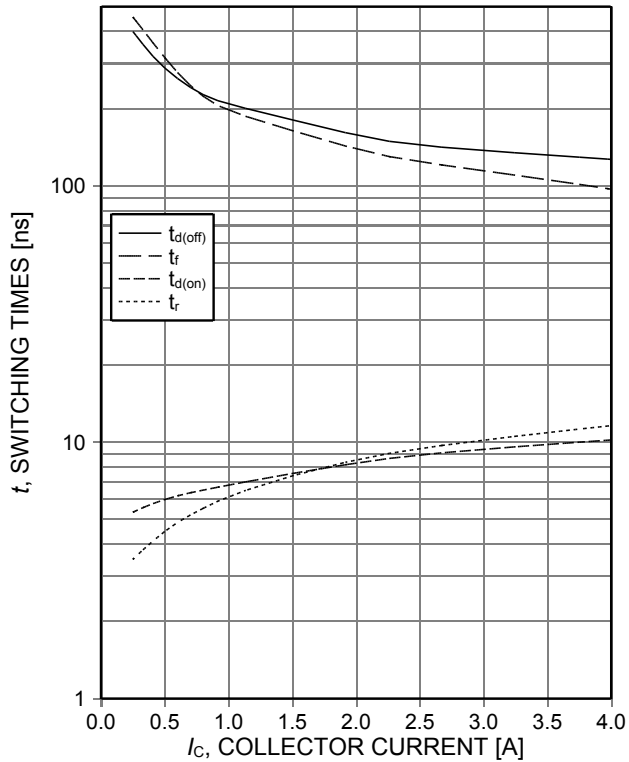

Figure 9. **Typical switching times as a function of collector current**
 (inductive load, $T_{vj}=175^{\circ}\text{C}$, $V_{CE}=400\text{V}$, $V_{GE}=0/15\text{V}$, $R_{Gon}=68\Omega$, $R_{Goff}=68\Omega$, dynamic test circuit in Figure E)

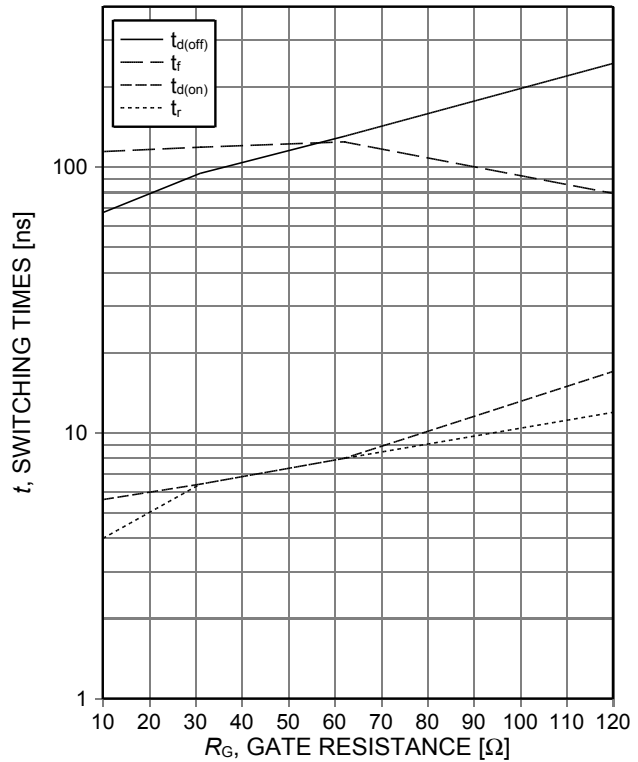

Figure 10. **Typical switching times as a function of gate resistance**
 (inductive load, $T_{vj}=175^{\circ}\text{C}$, $V_{CE}=400\text{V}$, $V_{GE}=0/15\text{V}$, $I_C=2,5\text{A}$, dynamic test circuit in Figure E)

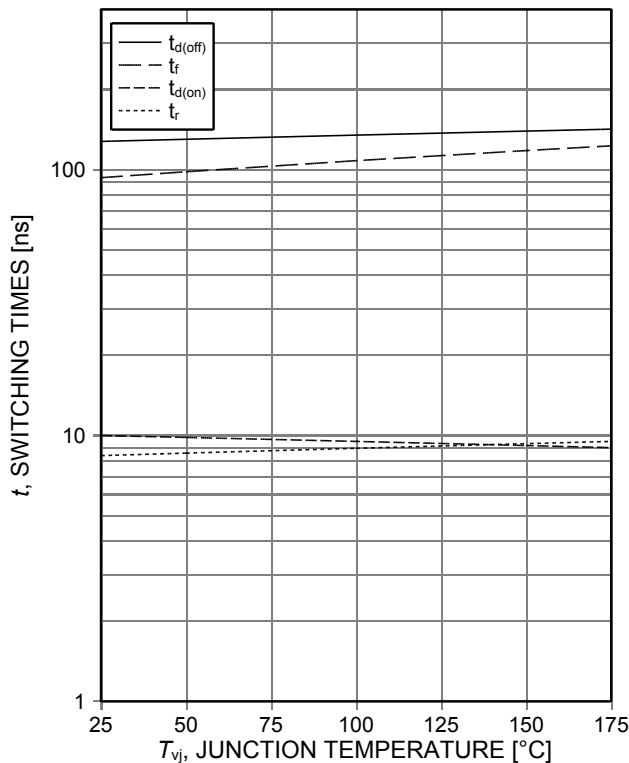

Figure 11. **Typical switching times as a function of junction temperature**
 (inductive load, $V_{CE}=400\text{V}$, $V_{GE}=0/15\text{V}$, $I_C=2,5\text{A}$, $R_{Gon}=68\Omega$, $R_{Goff}=68\Omega$, dynamic test circuit in Figure E)

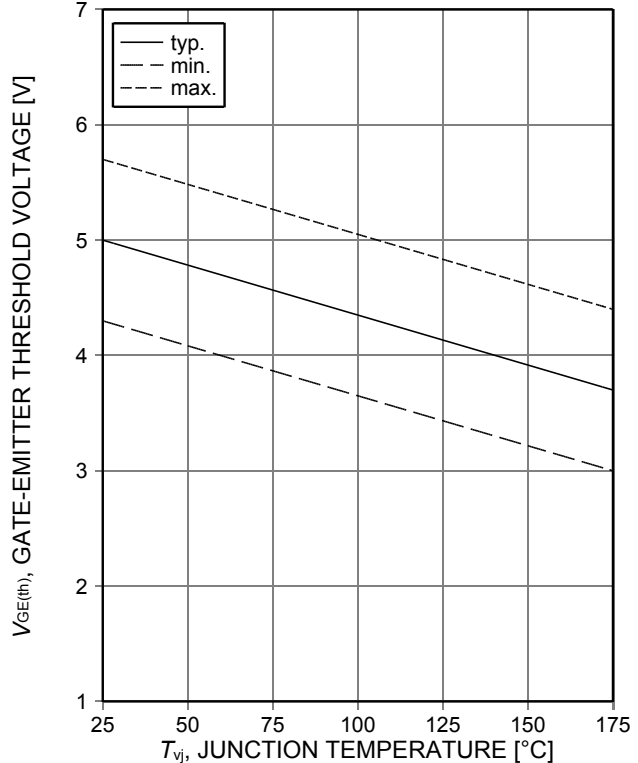

Figure 12. **Gate-emitter threshold voltage as a function of junction temperature**
 ($I_C=0,05\text{mA}$)

TRENCHSTOP™ RC-Drives Fast Series

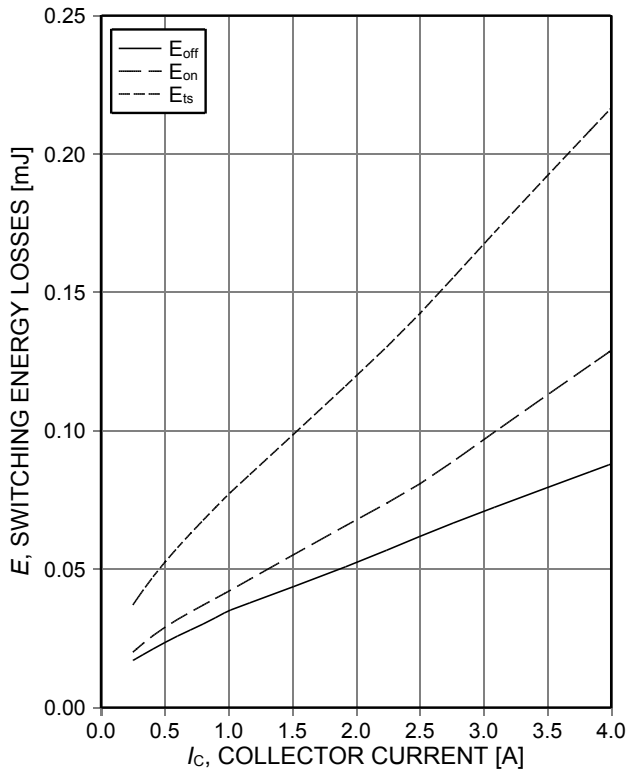

Figure 13. **Typical switching energy losses as a function of collector current**
 (inductive load, $T_{vj}=175^{\circ}\text{C}$, $V_{CE}=400\text{V}$, $V_{GE}=0/15\text{V}$, $R_{Gon}=68\Omega$, $R_{Goff}=68\Omega$, dynamic test circuit in Figure E)

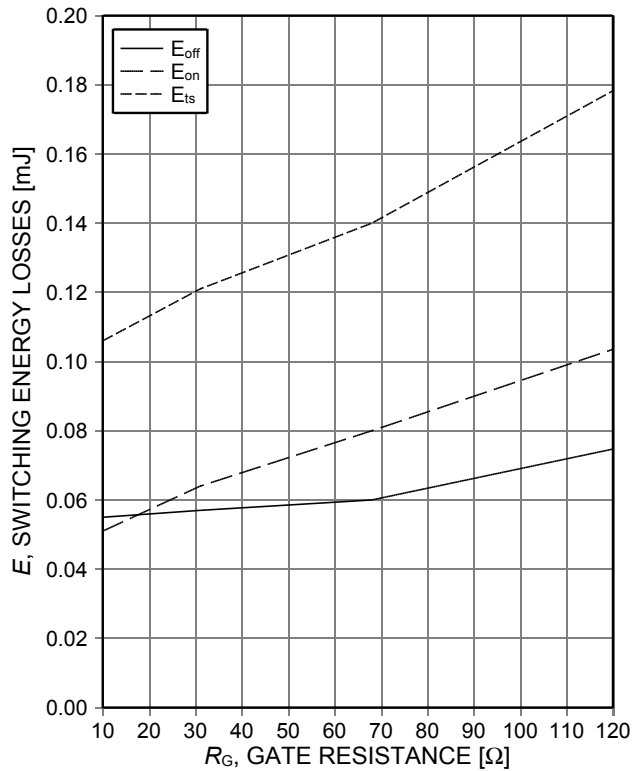

Figure 14. **Typical switching energy losses as a function of gate resistance**
 (inductive load, $T_{vj}=175^{\circ}\text{C}$, $V_{CE}=400\text{V}$, $V_{GE}=0/15\text{V}$, $I_c=2,5\text{A}$, dynamic test circuit in Figure E)

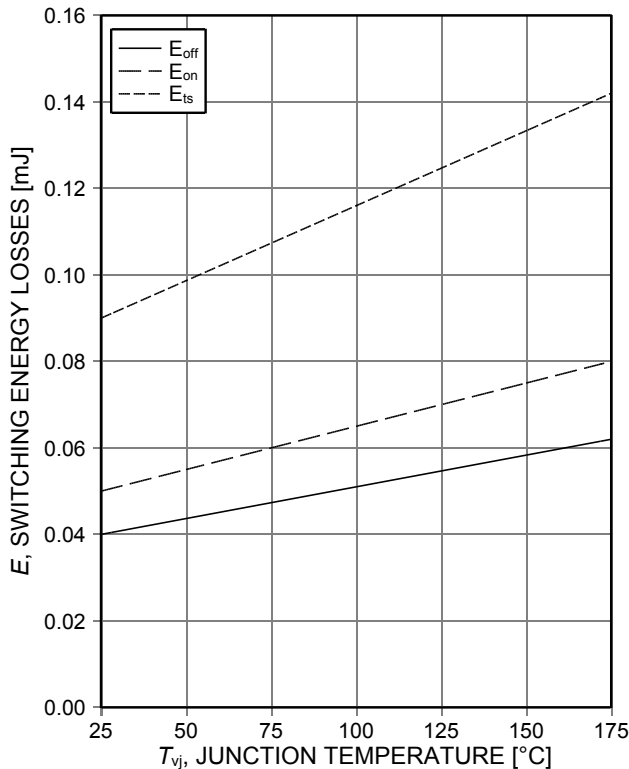

Figure 15. **Typical switching energy losses as a function of junction temperature**
 (inductive load, $V_{CE}=400\text{V}$, $V_{GE}=0/15\text{V}$, $I_c=2,5\text{A}$, $R_{Gon}=68\Omega$, $R_{Goff}=68\Omega$, dynamic test circuit in Figure E)

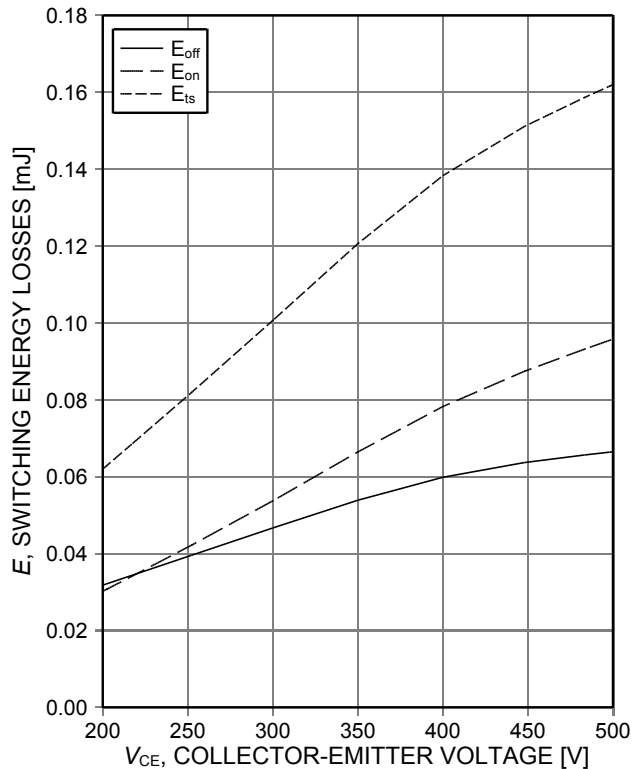

Figure 16. **Typical switching energy losses as a function of collector emitter voltage**
 (inductive load, $T_{vj}=175^{\circ}\text{C}$, $V_{GE}=0/15\text{V}$, $I_c=2,5\text{A}$, $R_{Gon}=68\Omega$, $R_{Goff}=68\Omega$, dynamic test circuit in Figure E)

TRENCHSTOP™ RC-Drives Fast Series

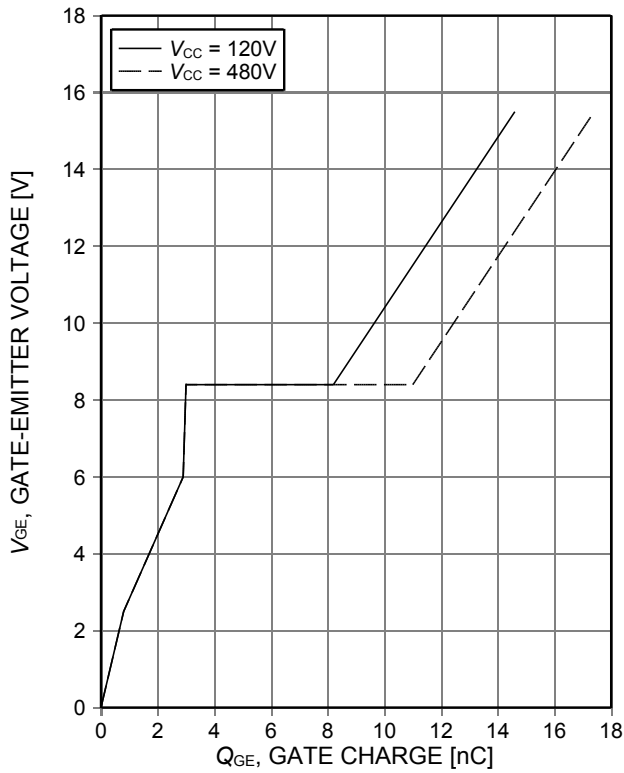

Figure 17. **Typical gate charge**
($I_C=2,5A$)

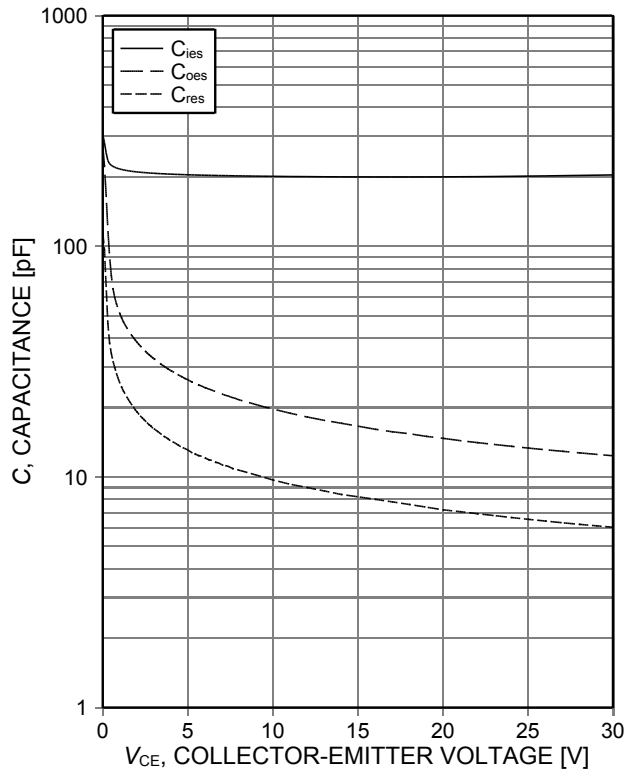

Figure 18. **Typical capacitance as a function of collector-emitter voltage**
($V_{GE}=0V, f=1MHz$)

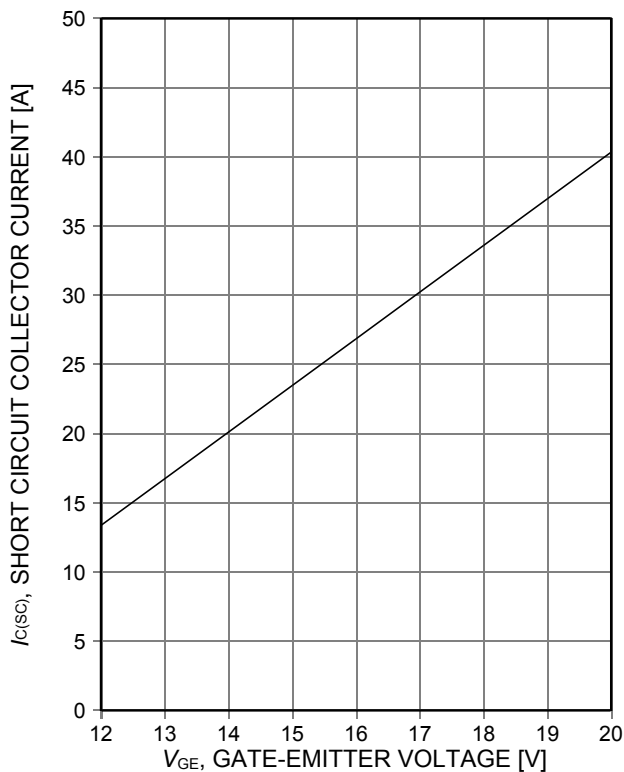

Figure 19. **Typical short circuit collector current as a function of gate-emitter voltage**
($V_{CE} \leq 400V$, start at $T_{vj}=25^\circ C$)

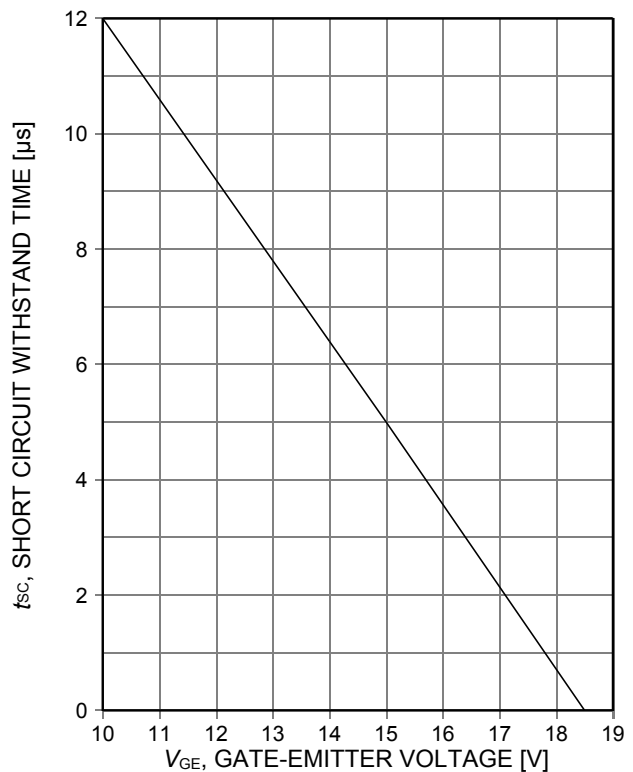

Figure 20. **Short circuit withstand time as a function of gate-emitter voltage**
($V_{CE} \leq 400V$, start at $T_{vj}=150^\circ C$)

TRENCHSTOP™ RC-Drives Fast Series

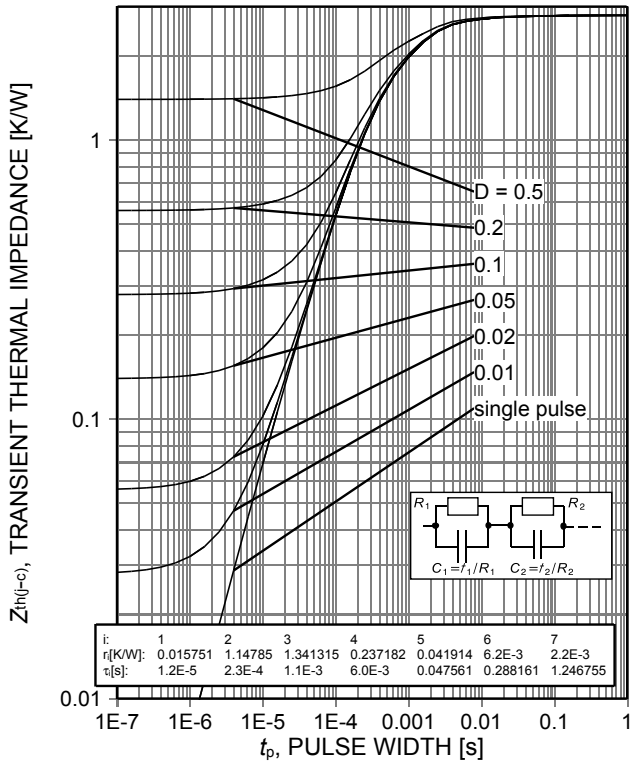

Figure 21. IGBT transient thermal impedance as a function of pulse width ¹⁾ (see page 4) ($D=t_p/T$)

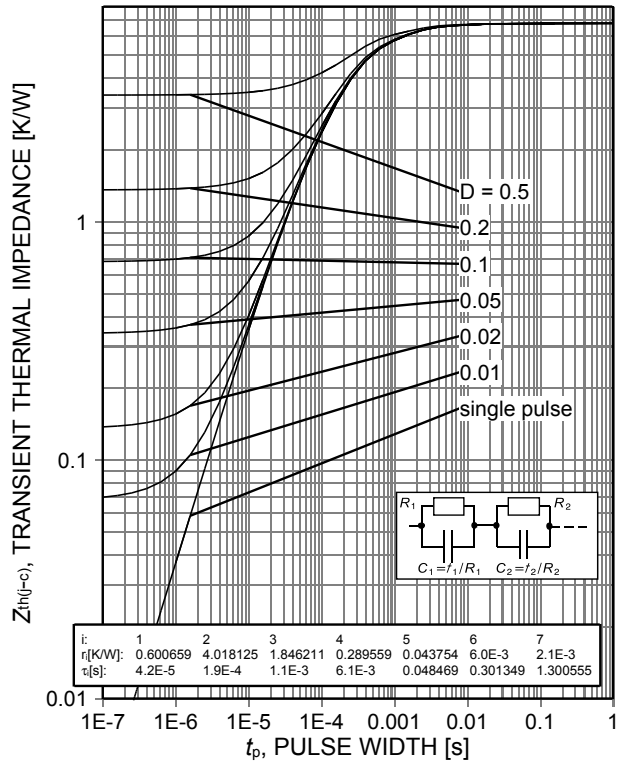

Figure 22. Diode transient thermal impedance as a function of pulse width ²⁾ (see page 4) ($D=t_p/T$)

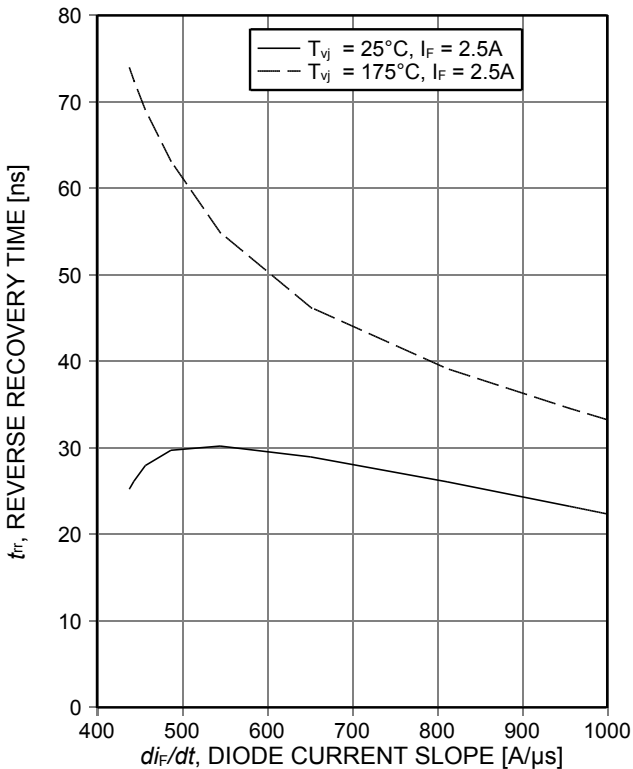

Figure 23. Typical reverse recovery time as a function of diode current slope ($V_R=400V$)

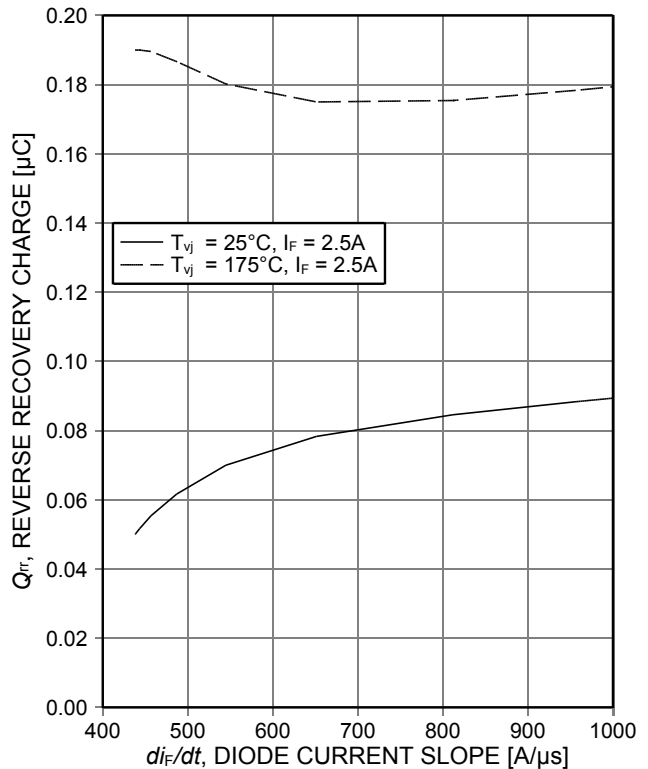

Figure 24. Typical reverse recovery charge as a function of diode current slope ($V_R=400V$)

TRENCHSTOP™ RC-Drives Fast Series

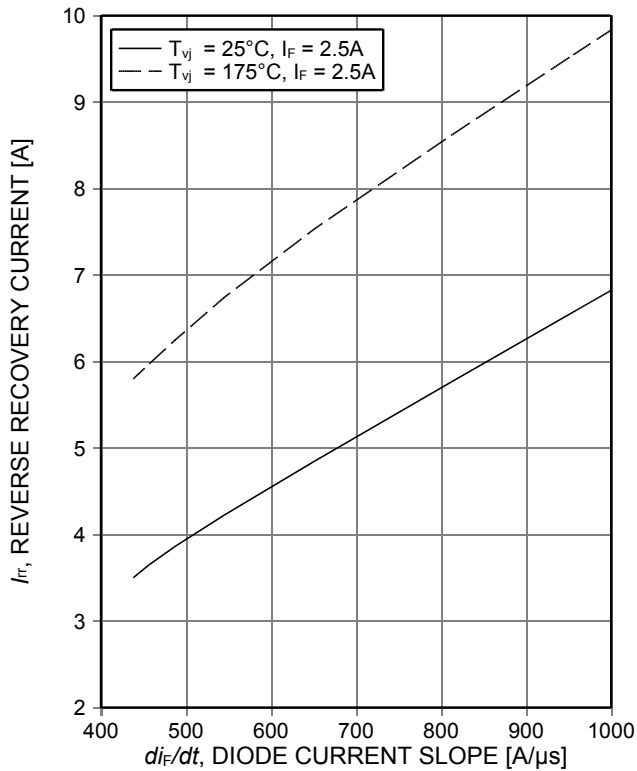

Figure 25. Typical reverse recovery current as a function of diode current slope (V_R=400V)

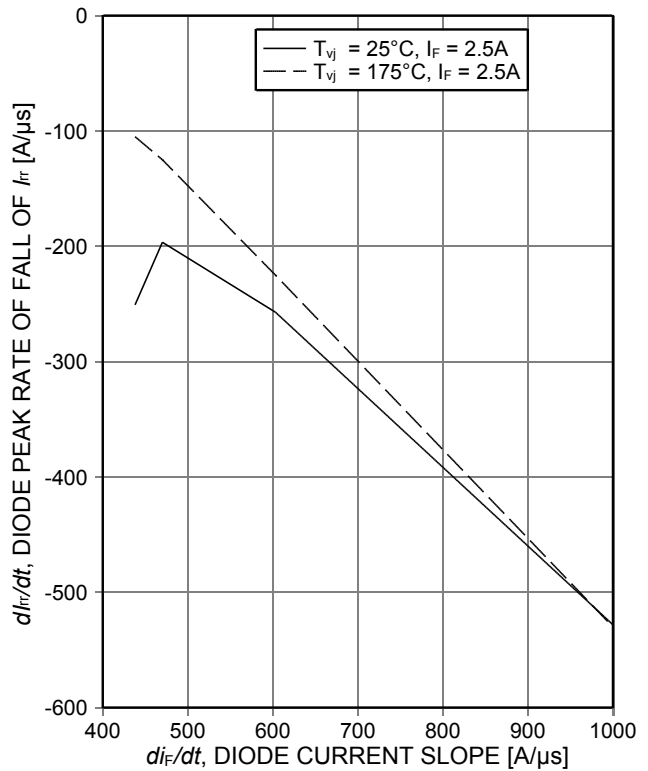

Figure 26. Typical diode peak rate of fall of reverse recovery current as a function of diode current slope (V_R=400V)

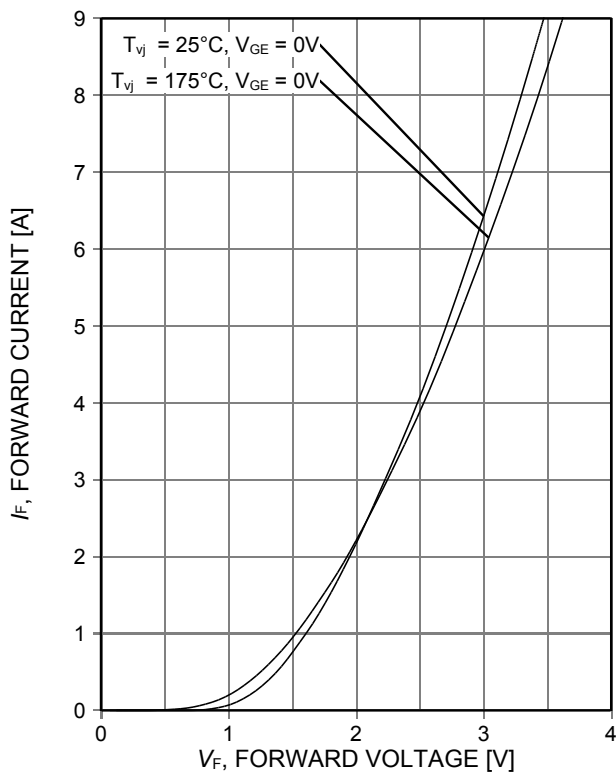

Figure 27. Typical diode forward current as a function of forward voltage

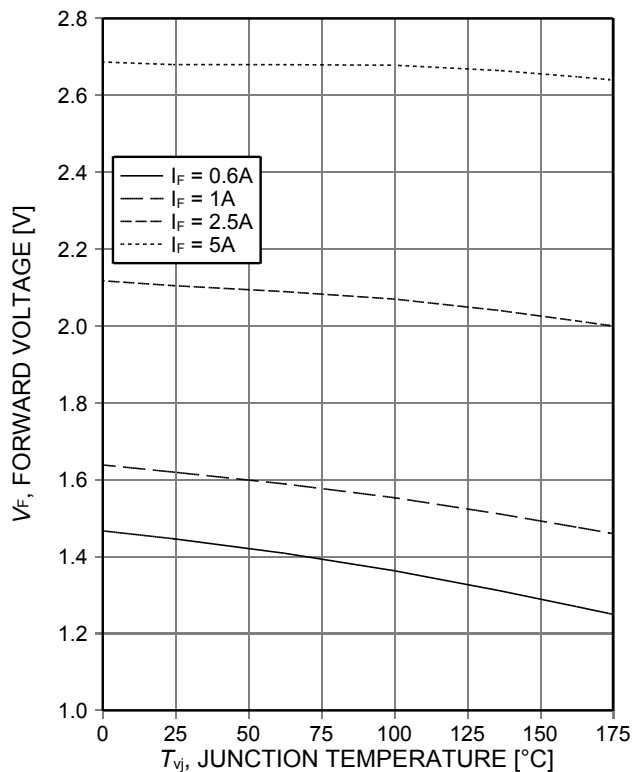
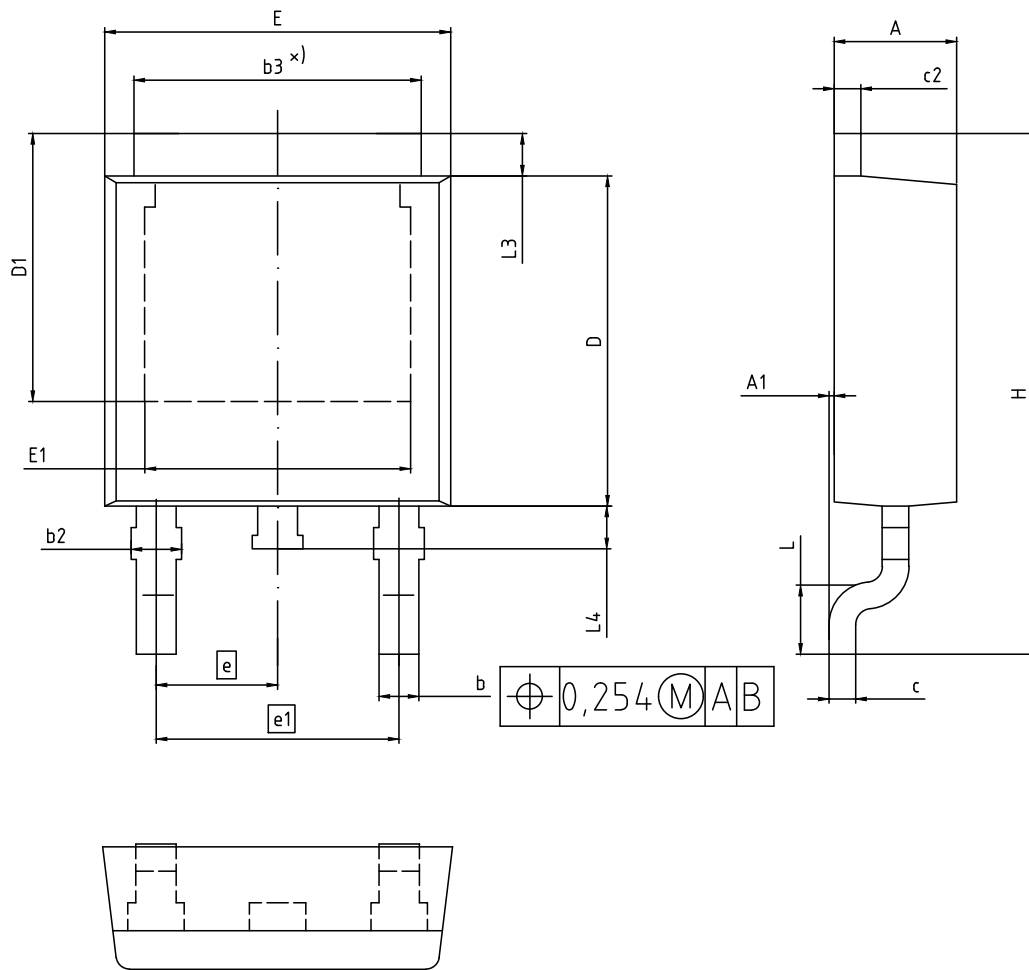

Figure 28. Typical diode forward voltage as a function of junction temperature

Package Drawing PG-TO252-3



NOTES:
 1. ALL DIMENSIONS REFER TO JEDEC STANDARD TO-252 DO NOT INCLUDE MOLD FLASH OR PROTRUSIONS.

DIM	MILLIMETERS	
	MIN	MAX
A	2.16	2.41
A1	0.00	0.15
b	0.64	0.89
b2	0.65	1.15
b3	4.95	5.50
c	0.46	0.61
c2	0.40	0.98
D	5.97	6.22
D1	5.02	5.84
E	6.35	6.73
E1	4.32	5.21
e	2.29 (BSC)	
e1	4.57 (BSC)	
N	3	
H	9.40	10.48
L	1.18	1.78
L3	0.89	1.27
L4	0.51	1.02

DOCUMENT NO.
Z8B00003328

SCALE

EUROPEAN PROJECTION

ISSUE DATE
05-02-2016

REVISION
06

Testing Conditions



Figure A. Definition of switching times



Figure B. Definition of switching losses

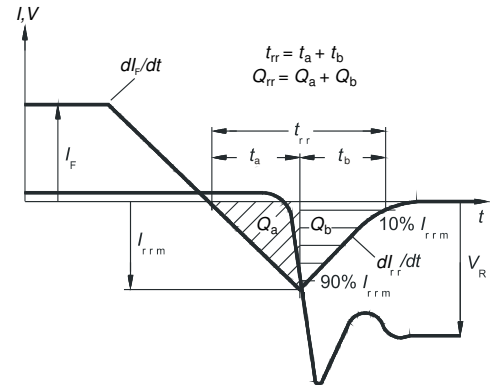

Figure C. Definition of diode switching characteristics

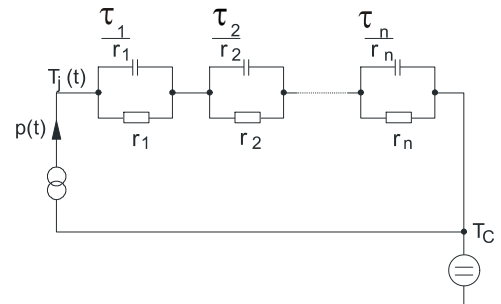

Figure D. Thermal equivalent circuit



Figure E. Dynamic test circuit
Parasitic inductance L_{σ} ,
parasitic capacitor C_{σ} ,
relief capacitor C_r ,
(only for ZVT switching)

TRENCHSTOP™ RC-Drives Fast Series**Revision History**

IKD03N60RF

Revision: 2016-05-10, Rev. 2.6

Previous Revision

Revision	Date	Subjects (major changes since last revision)
1.1	2011-06-07	Preliminary Data sheet
2.2	2012-02-23	Final data sheet
2.3	2013-12-10	New value ICES max limit at 175°C
2.4	2014-02-26	Without PB free logo
2.5	2014-03-12	Storage temperature -55...+150°C
2.6	2016-05-10	New maximum values $I_c(T_c)$, $I_F(T_c)$ and Figure 4

Trademarks

All referenced product or service names and trademarks are the property of their respective owners.

Published by
Infineon Technologies AG
81726 München, Germany
© Infineon Technologies AG 2018.
All Rights Reserved.

Important Notice

The information given in this document shall in no event be regarded as a guarantee of conditions or characteristics ("Beschaffenheitsgarantie"). With respect to any examples, hints or any typical values stated herein and/or any information regarding the application of the product, Infineon Technologies hereby disclaims any and all warranties and liabilities of any kind, including without limitation warranties of non-infringement of intellectual property rights of any third party.

In addition, any information given in this document is subject to customer's compliance with its obligations stated in this document and any applicable legal requirements, norms and standards concerning customer's products and any use of the product of Infineon Technologies in customer's applications.

The data contained in this document is exclusively intended for technically trained staff. It is the responsibility of customer's technical departments to evaluate the suitability of the product for the intended application and the completeness of the product information given in this document with respect to such application.

For further information on the product, technology, delivery terms and conditions and prices please contact your nearest Infineon Technologies office (www.infineon.com).

Please note that this product is not qualified according to the AEC Q100 or AEC Q101 documents of the Automotive Electronics Council.

Warnings

Due to technical requirements products may contain dangerous substances. For information on the types in question please contact your nearest Infineon Technologies office.

Except as otherwise explicitly approved by Infineon Technologies in a written document signed by authorized representatives of Infineon Technologies, Infineon Technologies' products may not be used in any applications where a failure of the product or any consequences of the use thereof can reasonably be expected to result in personal injury.

单击下面可查看定价，库存，交付和生命周期等信息

[>>Infineon\(英飞凌\)](#)