

XDPL8221 100W Reference Board Engineering Report

XDP™ Digital Power

About this document

Scope and purpose

This document contains the specification, schematic, bill of materials and measurement results of the 100 W form factor board as LED driver which using the Infineon XDPL8221 dual-stage multi-mode flyback + PFC combo controller.

Intended audience

This document is intended for anyone wishing to design high-performance dual-stage digital flyback AC-DC converters for LED lighting based on the PFC+Flyback combo controller XDPL8221.

Table of contents

About this document.....	1
Table of contents.....	1
1 Introduction	2
2 Design features	3
3 Design specification	4
4 Schematic and description	6
5 PCB Layout.....	7
6 XDPL8221 100 W Reference board measurement results.....	8
6.1 Operating window.....	8
6.2 Performance.....	8
6.3 0 to 10 V Linear dimming.....	14
6.4 0 to 10 V Eye-adapted dimming.....	15
6.5 Time-to-light.....	16
6.6 Standby power consumption	16
6.7 EMI Performance	17
7 Bill of Materials	18
7.1 Transformer specification.....	24
Revision history.....	26

Introduction

1 Introduction

XDPL8221 100 W reference design is a digitally configurable LED driver which has an universal input of 90 to 305 V_{AC} or 90 to 430 V_{DC} , and wide output load range of 16 to 48 V_{DC} with isolated dimming interface (with CDM10VD). Please refer next page for the main design features of this board based on XDPL8221 and CDM10VD.

Note: The 100 W reference design is ready for evaluation without the need of any pre-programming by the user as the XDPL8221 chip on PCB has already been burned with the default full set of working parameters configuration. Please connect the AC Input, LED output and dimming input as shown in Figure 1, for the test setup. Once the IC controller XDPL8221 on the referene board is changed to a new one, the 100 W reference board parameters must be burned again because the default parameters in XDPL8221 are for 50 W reference board.

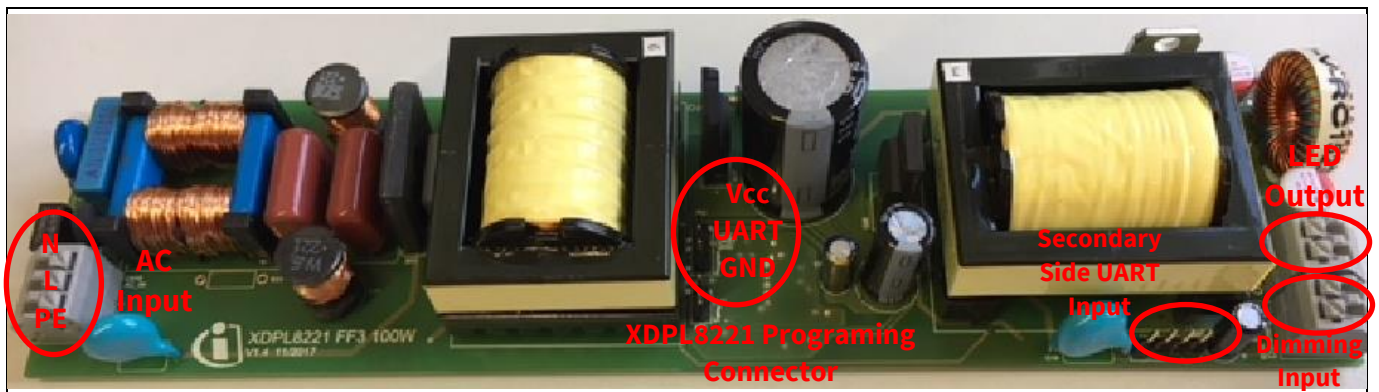

Figure 1 XDPL8221 100 W Reference board

Design features

2 Design features

XDPL8221 100 W reference board as LED driver has following design features:

- Dual-stage flyback and separated power factor correction (PFC) with high-precision primary side-controlled constant voltage (CV), constant current (CC) and limited power (LP) output.
- Excellent current accuracy of typical +/-2% across universal input voltage range (90 to 305 V_{AC}) and wide output voltage range (from 16 V_{DC} to 48 V_{DC})
- Integrated 600 V HV cell and PFC aux winding charge pump power supply for fast startup start time under 250 ms
- Flyback stage with multi-mode control (QR1 + DCM + ABM) enables high efficiency and low dimming output
- High power factor (PF>0.9) and low input current total harmonic distortion (iTHD < 15%) across universal input voltage range (90 to 305 V_{AC} or 90 to 430 V_{DC}) and down to 30% of nominal load
- Low Bill Of Materials (BOM)
- Configurable dimming curve to either linear or quadratic (eye-adaptive).
- Configurable minimum dimming current down to 1%
- Intelligent thermal management with adaptive temperature protection
- Active bleeder for dim-to-off function
- UART command interface to to control the operation of the LED driver as well as to read out the operating status information from the digital controller XDPL8221
- Output independent forward mode auxiliary power supply for an accurate primary side regulation
- Isolated 0-10 V dimming interface with CDM10VD

Note: CDM10VD is a fully integrated 0-10 V dimming interface IC from Infineon which transmits secondary auxiliary side analog voltage based signals from 0-10 V dimmer to primary side, by driving an external opto-coupler with a 5 mA current based PWM signal. For more details about CDM10VD, please visit Infineon website: <http://www.infineon.com/CDM10VD>.

3 Design specification

Table 1 and **Table 2** list the electrical specification and system protection of this reference design.

Table 1 Electrical specification

Specification	Symbol	Value	Unit
AC Input voltage range	V_{IN_AC}	90 to 305	V_{AC}
DC Input voltage range	V_{IN_DC}	90 to 430	V_{DC}
Output LED load range (includes dimming) ¹	V_{LED}	16 to 48	V_{DC}
Non-dimmed full output current setting ²	I_{out_set}	2500	mA
Total line and load regulation tolerance	-	± 2	%
Dimming input voltage range	V_{DIM}	0 to 10	V
Limited Maximum Power	P_{lim}	100	W
PWM Dimming frequency	f_{dim}	500 to 1500	Hz
Minimum output current setting ²	$I_{out_dim_min}$	25	mA
Output current dimming curve ²	C_{dim}	Linear or quadratic	-
Efficiency (V_{out} : 48 V_{DC} , I_{out} : 2.08A, non-dimming)	η	< 89	%
Power factor (V_{in} : 120 to 277 V_{AC} +/-10%, V_{out} : 29 to 48 V_{DC} , >30% load)	PF	> 0.9	-
Input current total harmonic distortion (V_{in} : 120 to 277 V_{AC} +/-10%, V_{out} : 29 to 48 V_{DC} , >30% load)	iTHD	< 15	%

¹ Configurable in XDPL8221

² Configurable in XDPL8221

Table 2 System protections

Protection	Symbol	Value	Unit
Nominal Input over-voltage protection level ¹	V_{in_OV}	320	V_{AC}
Nominal Input under-voltage protection level ¹	V_{in_UV}	76	V_{AC}
Nominal output over-voltage protection level ²	V_{out_OV}	53	V_{DC}
Nominal output over-current (average) protection level ²	$I_{out_max_avg}$	2500	mA
IC internal over-temperature detection threshold ¹	$T_{critical}$	119	°C
Input over-voltage protection reaction ³	Reaction_OVP_Vin	Auto-restart	-
Input under-voltage protection reaction ³	Reaction_UVP_Vin	Auto-restart	-
Bus over-voltage protection level 2	Reaction_OVP2_Vbus	Auto-restart	-
Primary over-current protection level 2	Reaction_OCP2	Auto-restart	-
Output over-voltage (output open) protection reaction ³	Reaction_OVP_Vout	Auto-restart	-
Output under-voltage (output short) protection reaction ³	Reaction_UVP_Vout	Auto-restart	-
Output over-current (average) protection reaction ³	Reaction_Iout_max_avg	Auto-restart	-
IC over-temperature protection reaction ³	Reaction_TP	Auto-restart	-
Auto-restart idle time ⁴	$t_{auto_restart}$	1	s
Fast auto-restart idle time ⁵	$t_{fast_auto_restart}$	400	ms

¹ Protection can be disabled and its level can be configured.

² Protection cannot be disabled and its level can be configured.

³ Protection reaction can be configured as either auto-restart or latched mode

⁴ Auto-restart time can be configured.

⁵ Fast auto-restart time can be configured.

5 PCB Layout

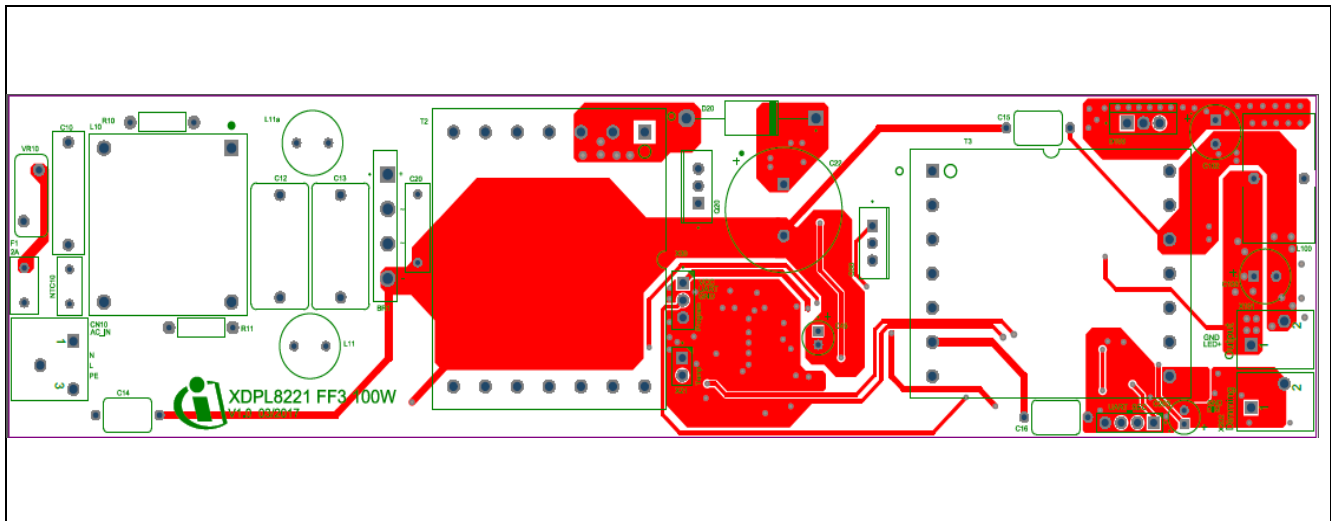

Figure 3 PCB Top side

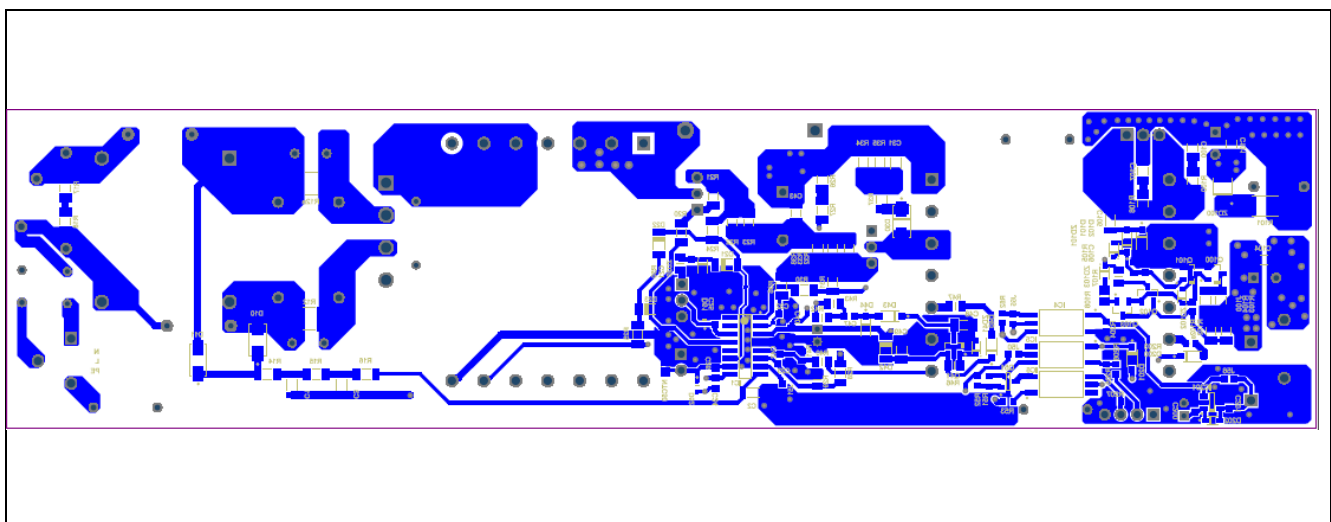

Figure 4 PCB Bottom side

6 XDPL8221 100 W Reference board measurement results

6.1 Operating window

The operating window of the XDPL8221 100 W reference board is measured with an electronic load $V_{ac} = 230\text{ V}$ / 50 Hz at room temperature.

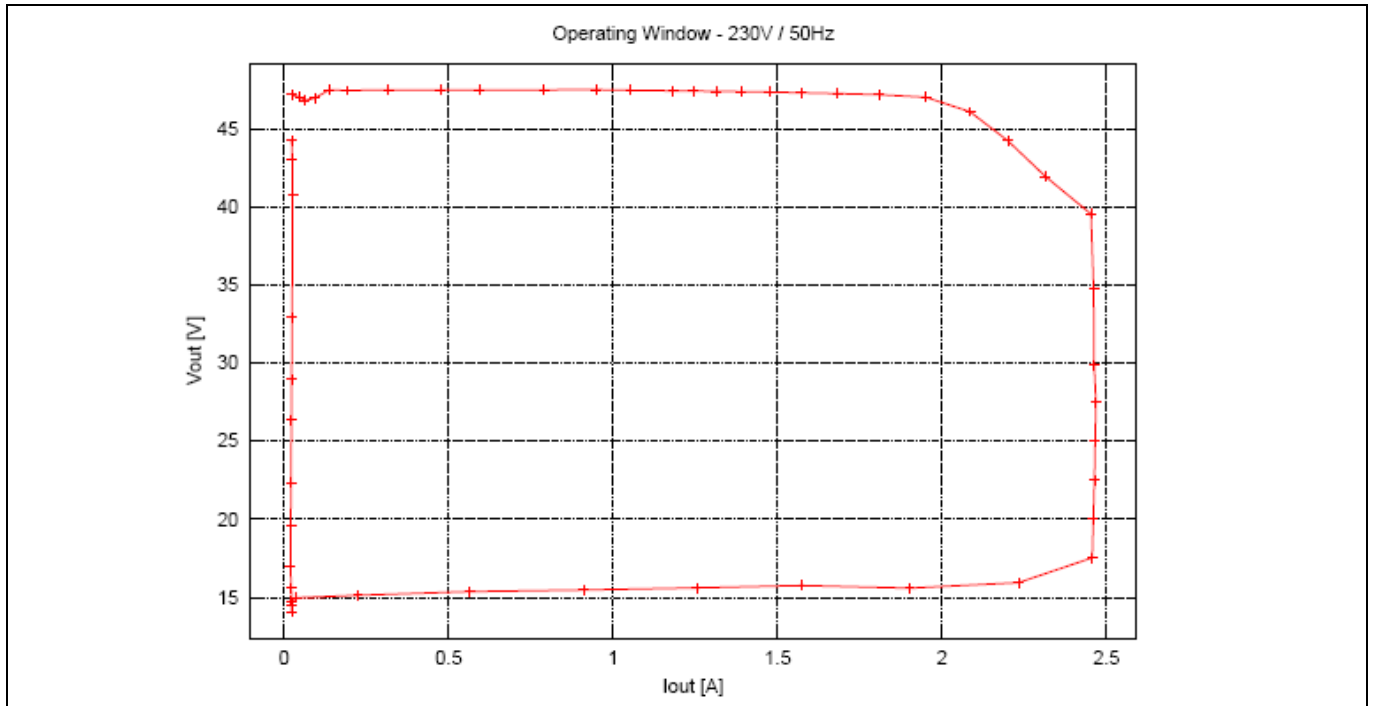

Figure 5 XDPL8221 100 W Reference board operating window

6.2 Performance

Table 3 Measurement result with 5 LEDs

V_{IN} (V _{AC})	P_{IN} (W)	V_{OUT} (V)	I_{OUT} (A)	Ripple (PK) (mA)	Power factor	THD (%)	η (%)
120	52	16.83	2.49 (100%)	63.7	0.993	9.98	80.8
140	51.5	16.80	2.49	63.4	0.993	8.32	81.3
200	50.9	16.75	2.49	63.8	0.983	6.12	82.2
220	50.8	16.73	2.49	64.0	0.977	5.98	82.3
230	50.6	16.71	2.49 (100%)	64.3	0.973	5.8	82.4
240	50.6	16.69	2.49	64.0	0.969	5.83	82.36
264	50.4	16.67	2.49	64.4	0.956	5.1	82.7
277	50.34	16.65	2.49 (100%)	64.8	0.948	5.2	82.6

XDPL8221 100 W Reference board measurement results

Table 4 Measurement result with 10 LEDs

V _{IN} (V _{AC})	P _{IN} (W)	V _{OUT} (V)	I _{OUT} (A)	Ripple (PK) (mA)	Power factor	THD (%)	η (%)
120	95.9	32.72	2.49 (100%)	44.2	0.997	7.3	82.7
	47.3	30.8	1.25 (50%)	56.2	0.994	8.1	82.2
140	97.4	32.76	2.49	44.3	0.996	7.9	84.2
200	95.6	32.79	2.49	44.0	0.994	5.7	85.8
220	95.6	32.83	2.5	43.9	0.992	4.7	85.9
230	95.6	32.87	2.50 (100%)	43.5	0.991	4.6	86.1
	46.3	30.8	1.26 (50%)	59.3	0.967	6.2	84.1
240	95.5	32.95	2.50	43.8	0.990	4.5	86.2
264	95.6	33.01	2.50	43.6	0.986	4.6	86.5
277	95.9	33.16	2.50 (100%)	43.3	0.983	4.7	86.6
	46.3	30.7	1.27 (50%)	58.4	0.937	5.6	84.3

Table 5 Measurement result with 14 LEDs

V _{IN} (V _{AC})	P _{IN} (W)	V _{OUT} (V)	I _{OUT} (A)	Ripple (PK) (mA)	Power factor	THD (%)	η (%)
120	120.2	45.31	2.20 (100%)	42.8	0.997	6.8	83.9
	56.3	42.15	1.10 (50%)	55.9	0.993	9.8	82.9
	28.3	40.02	0.56 (25%)	26.3	0.987	11.1	80.2
140	117.8	45.15	2.20	42.7	0.996	7.4	84.8
200	114.9	45.02	2.21	42.9	0.995	5.5	86.7
220	114.5	44.87	2.22	43.1	0.994	5.3	87.1
230	114.3	44.82	2.22 (100%)	43.2	0.993	5.2	87.3
	54.9	42.23	1.10 (50%)	56.1	0.977	5.8	85.1
	27.9	40.07	0.56 (25%)	26.7	0.924	6.6	81.0%
240	114.2	44.73	2.22	43.1	0.992	5.2	87.3
265	114.0	44.69	2.23	43.1	0.989	4.4	87.5
277	113.7	44.63	2.23 (100%)	43.0	0.984	4.6	87.6

XDPL8221 100 W Reference board measurement results

	54.3	42.26	1.12 (50%)	43.8	0.956	5.2	85.6
	27.0	39.21	0.57 (25%)	27.2	0.867	7.5	81.2

Note: Due to the limited power mode, the current is limited so that the output power does not exceed the defined 100 W.

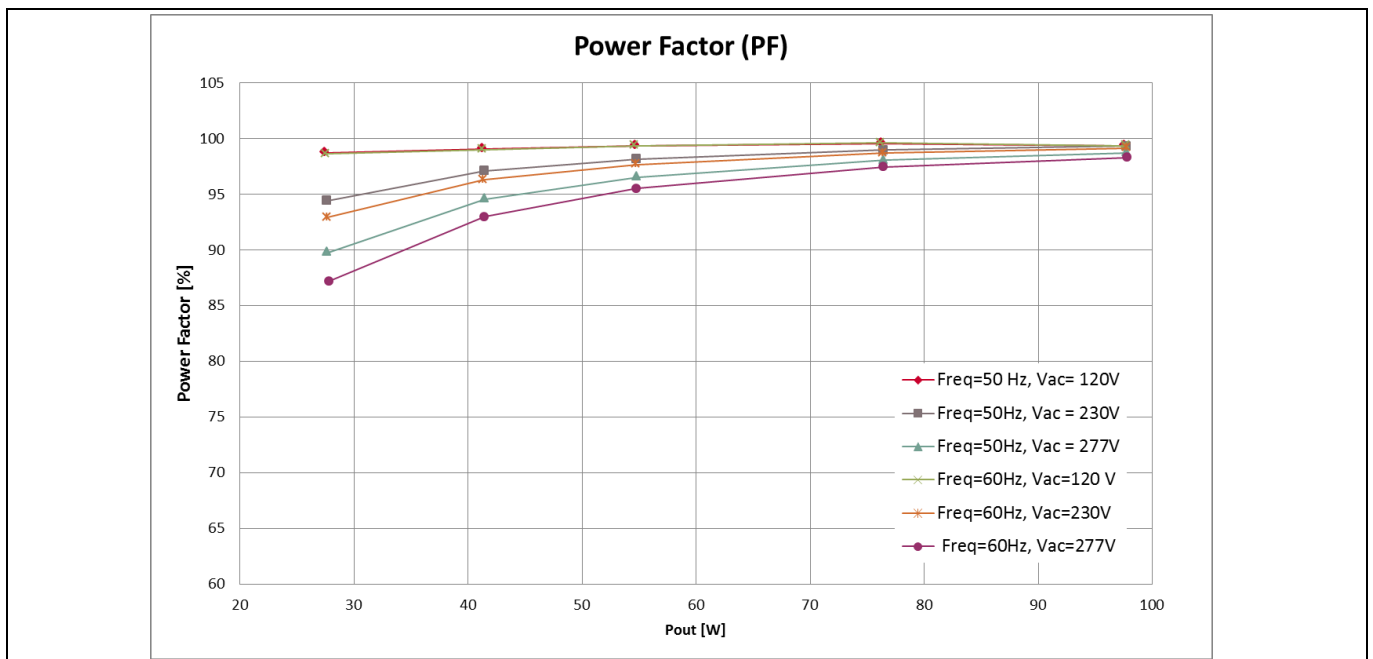

Figure 6 XDPL8221 100 W Reference board power factor with 14 LEDs

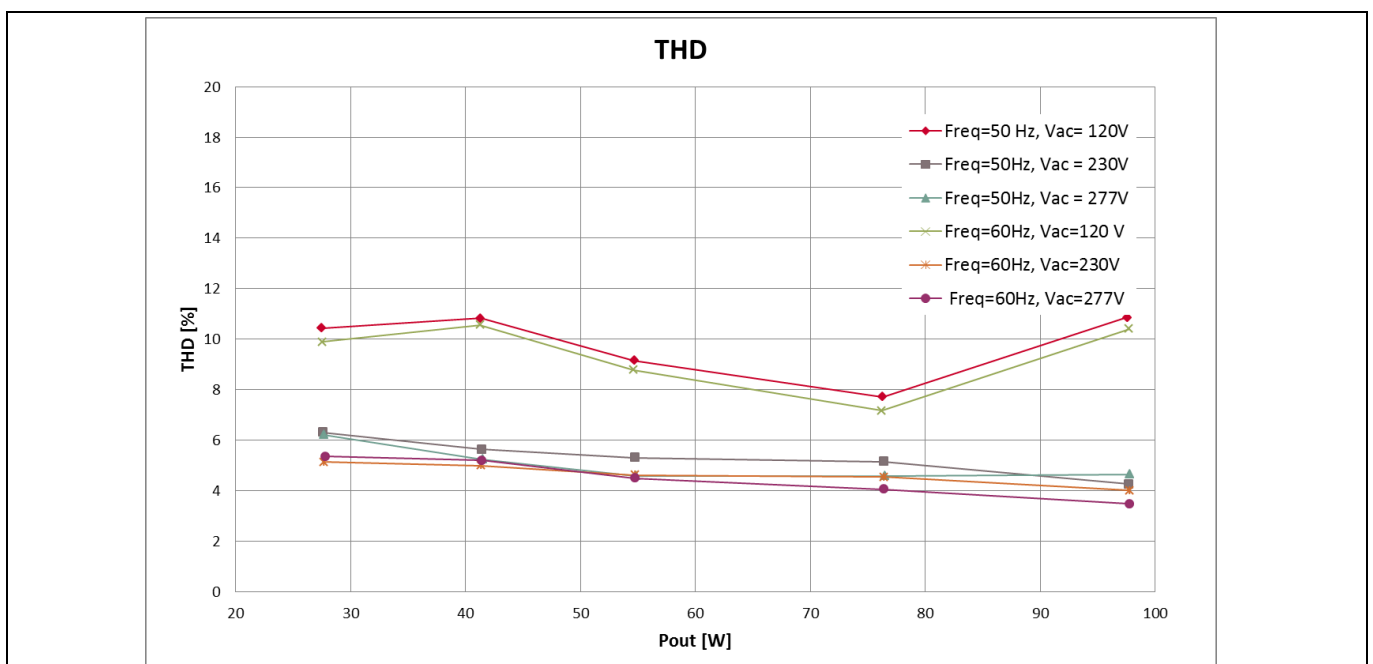

Figure 7 XDPL8221 100 W Reference board THD with 14 LEDs

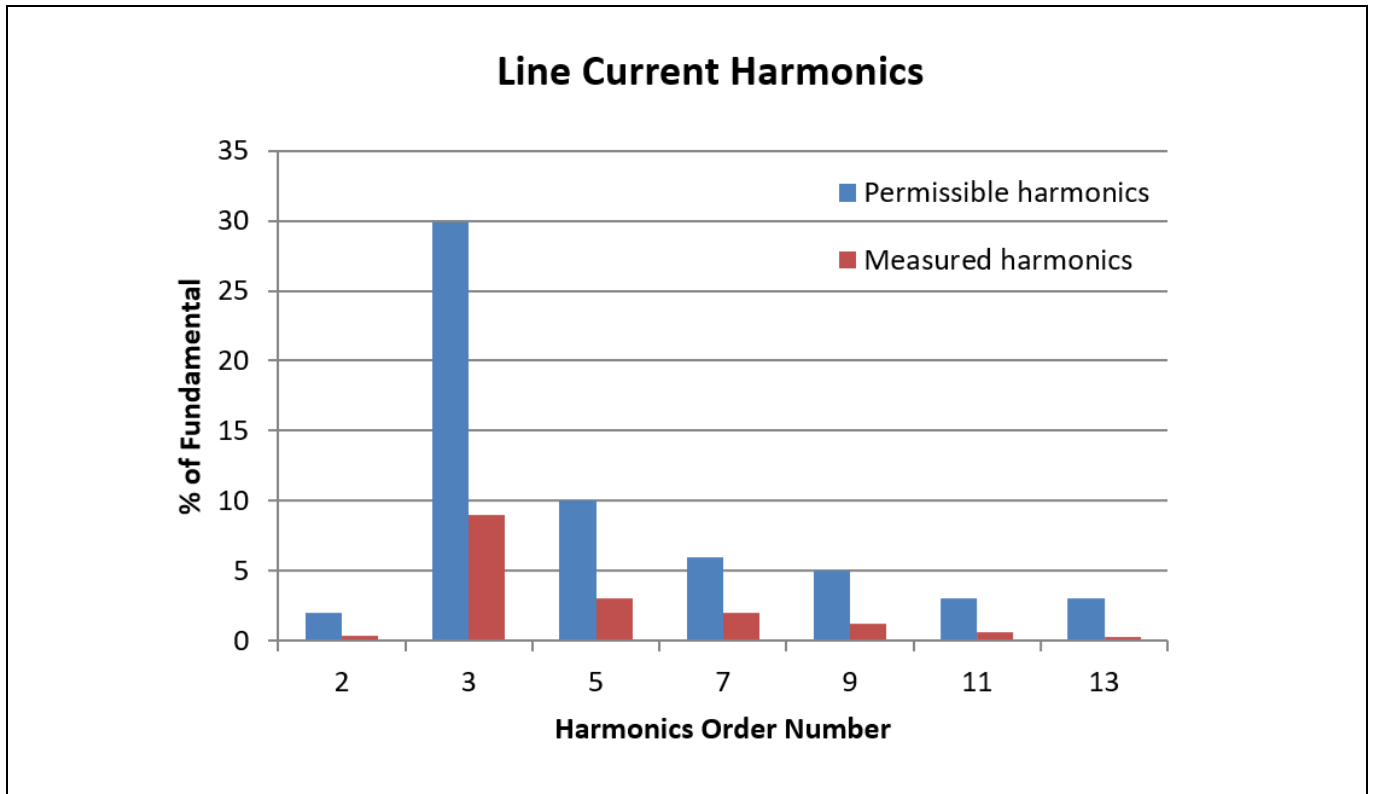

Figure 8 Line current harmonics $V_{AC} = 90\text{ V}/60\text{ Hz}$, 100% dimming

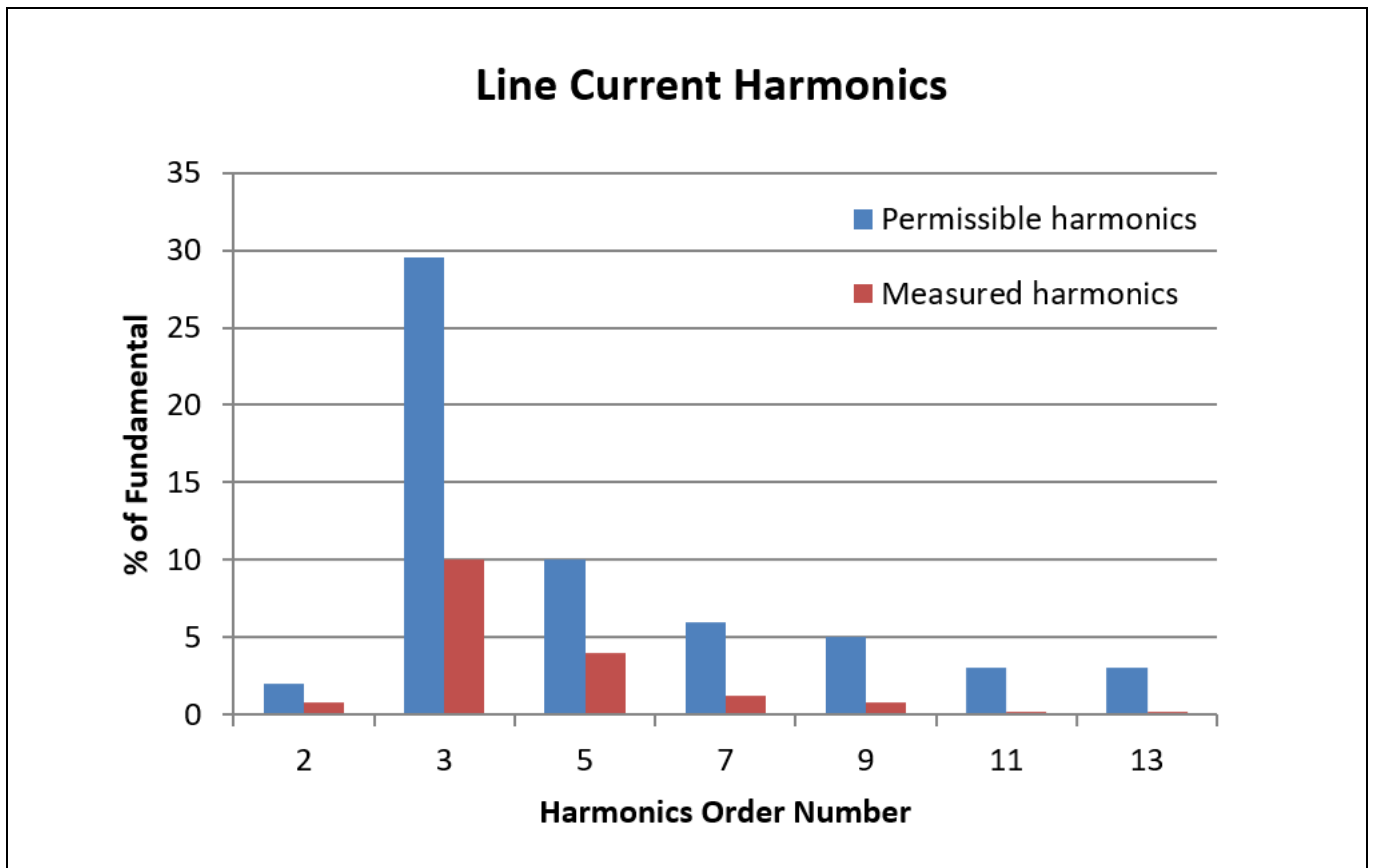

Figure 9 Line current harmonics $V_{AC} = 90\text{ V}/60\text{ Hz}$, 30% dimming

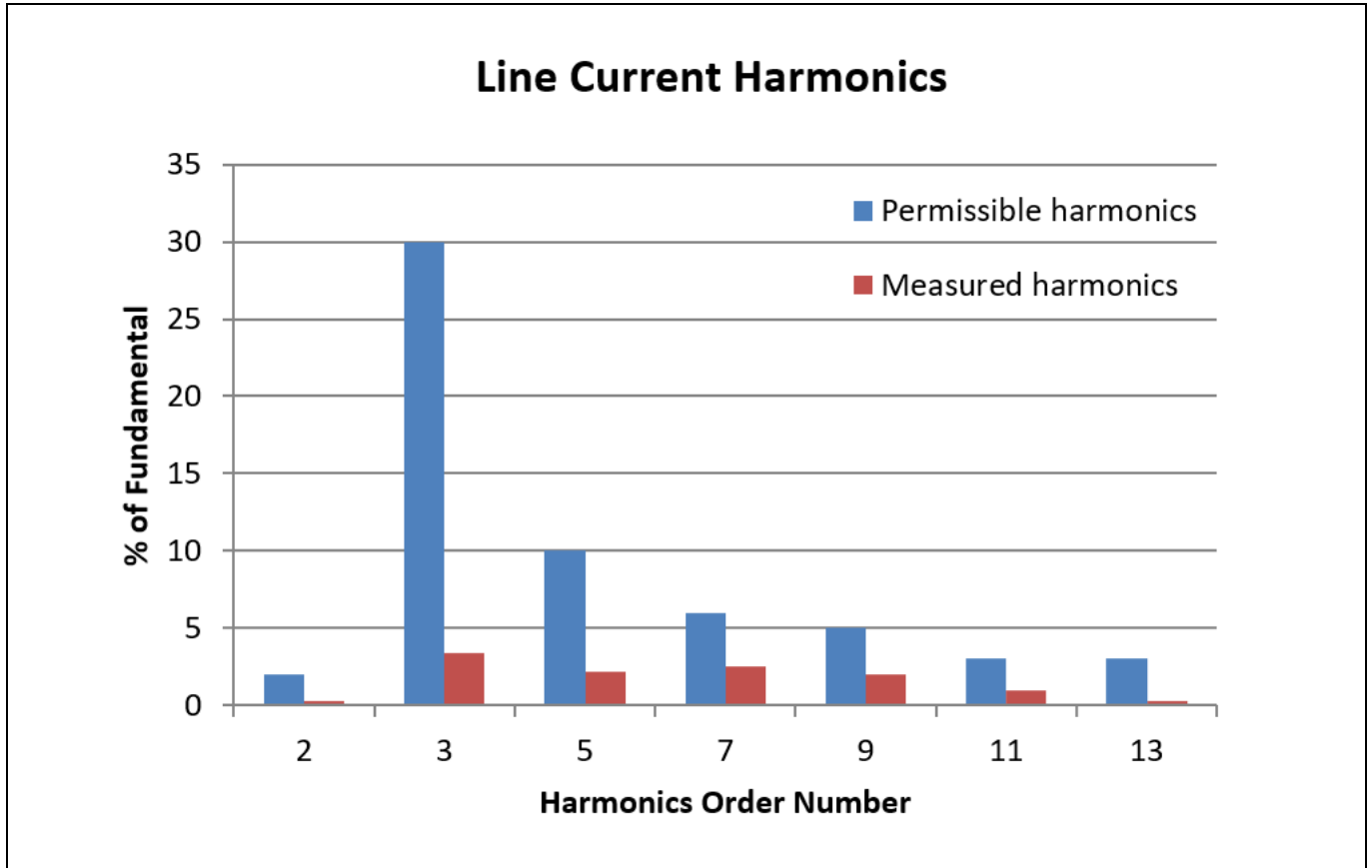

Figure 10 Line current harmonics $V_{AC} = 230\text{ V}/60\text{ Hz}$, 100% dimming

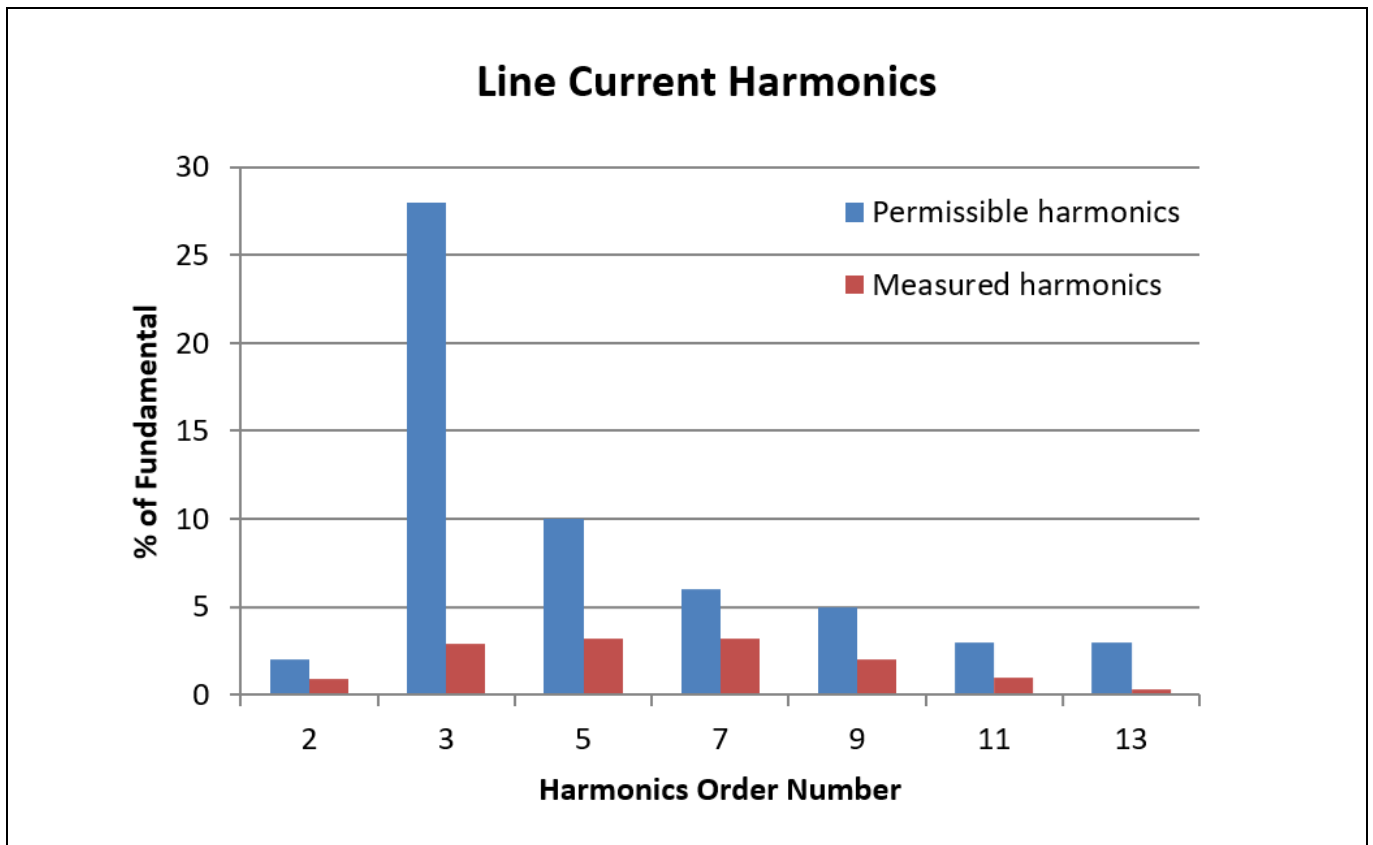

Figure 11 Line current harmonics $V_{AC} = 230\text{ V}/60\text{ Hz}$, 30% dimming

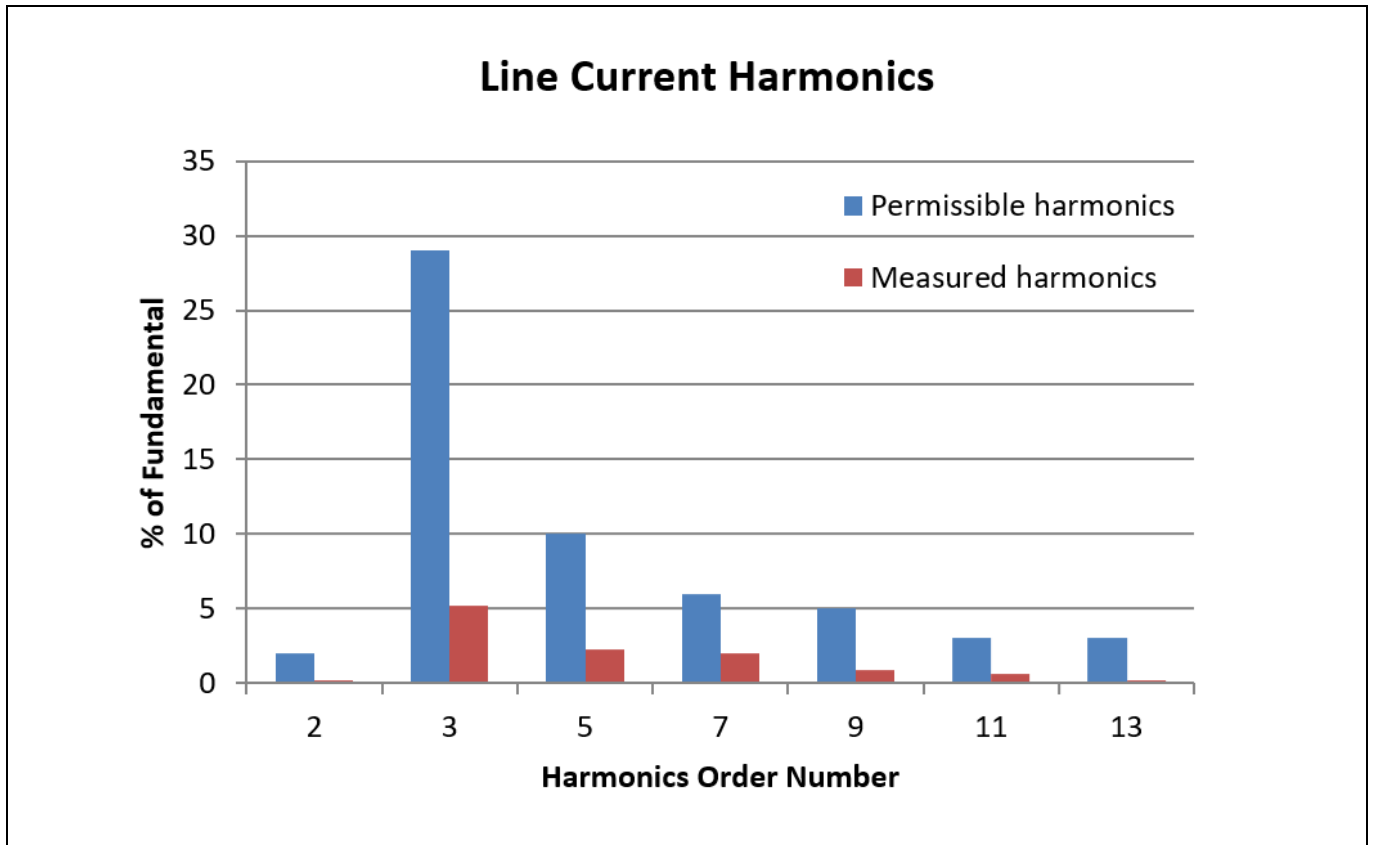

Figure 12 Line current harmonics $V_{AC} = 277\text{ V}/60\text{ Hz}$, 100% dimming

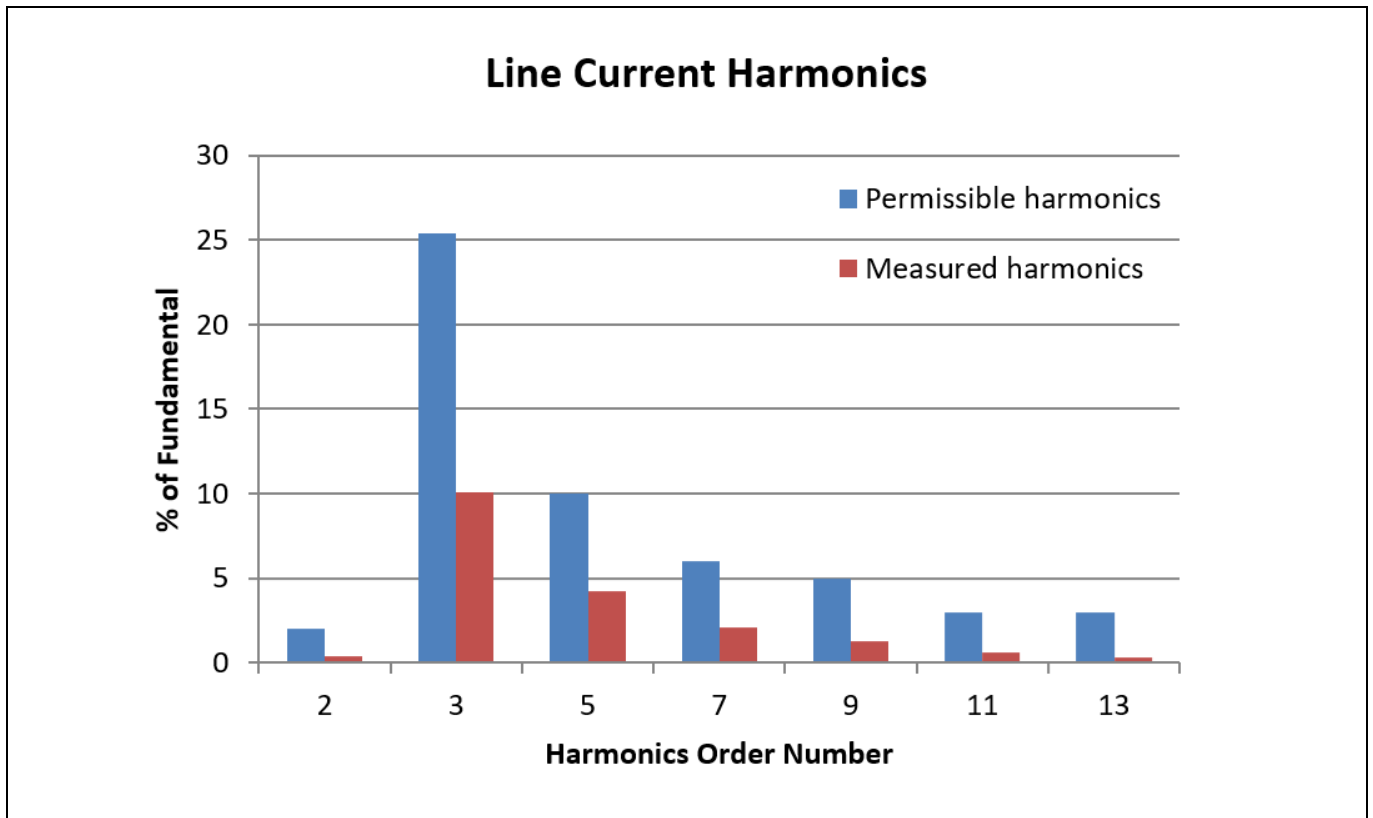

Figure 13 Line current harmonics $V_{AC} = 277\text{ V}/60\text{ Hz}$, 30% dimming

6.3 0 to 10 V Linear dimming

This section provides measurement results for the 0 to 10 V dimming feature. A linear curve was configured for this measurement using the .dpVision GUI. The measurement was done for an input voltage of 230 VAC, 50 Hz and an output load of 14 LEDs (45 V at maximum limited current).

Table 6 Output current at different dimming voltages with 14 LEDs

Vdim (V)	0.50	1.00	1.50	2.00	2.50	3.00	3.50	4.00	4.50	5.00
Io (A)	0.023	0.023	0.023	0.25	0.39	0.59	0.75	0.91	1.08	1.23
Vdim (V)	5.50	6.00	6.50	7.00	7.50	8.00	8.50	9.00	9.50	10.00
Io (A)	1.37	1.53	1.67	1.80	1.93	2.07	2.19	2.21	2.21	2.21

Note: Due to the limited power mode, the current is limited so that the output power does not exceed the defined 100 W.

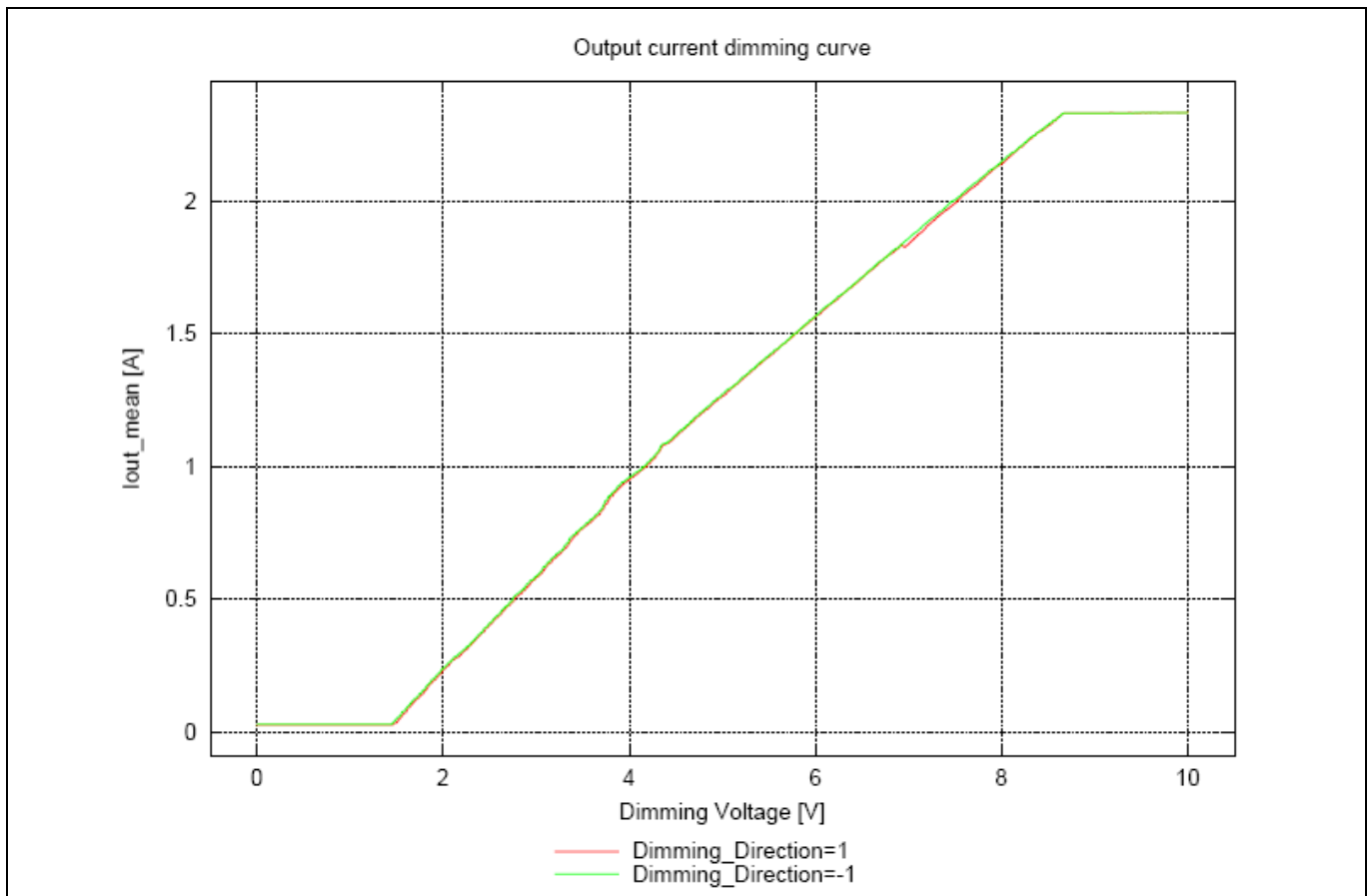

Figure 14 XDPL8221 100 W Reference board linear dimming curve with Vac = 230 V/50 Hz, 14 LEDs

6.4 0 to 10 V Eye-adapted dimming

This section provides measurement results for the 0 to 10 V dimming feature with an eye-adapted (quadratic) curve. The measurement was done for an input voltage of 230 VAC, 50 Hz and an output load of 14 LEDs (45 V at maximum limited current).

Table 7 Output current at different dimming voltages with 14 LEDs

Vdim (V)	0.50	1.00	1.50	2.00	2.50	3.00	3.50	4.00	4.50	5.00
Io (A)	0.031	0.031	0.033	0.046	0.09	0.165	0.249	0.37	0.506	0.67
Vdim (V)	5.50	6.00	6.50	7.00	7.50	8.00	8.50	9.00	9.50	10.00
Io (A)	0.86	1.05	1.24	1.46	1.702	1.96	2.22	2.27	2.27	2.27

Note: Due to the limited power mode, the current is limited so that the output power does not exceed the defined 100 W.

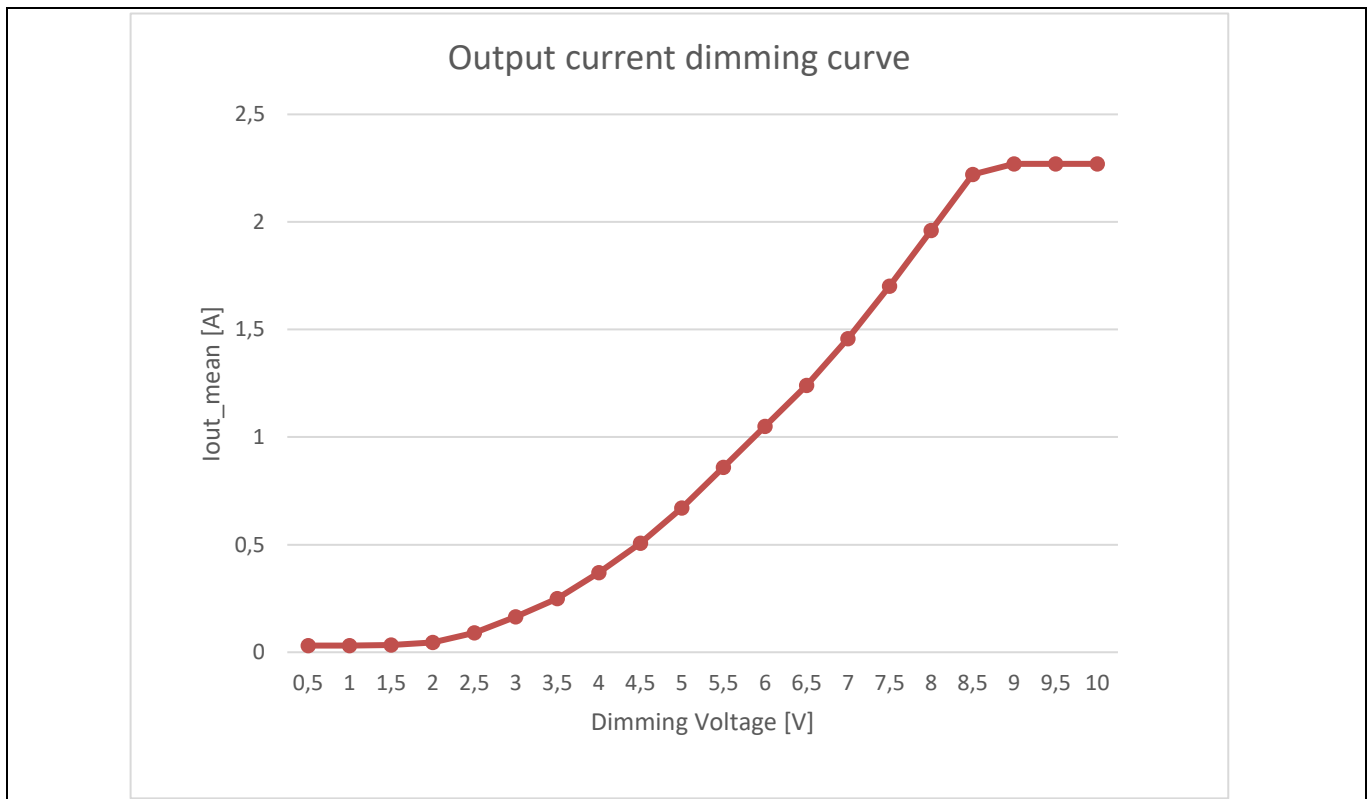

Figure 15 XDPL8221 100 W Reference board eye-adapted dimming curve with Vac = 230 V/50 Hz , 14 LEDs

6.5 Time-to-light

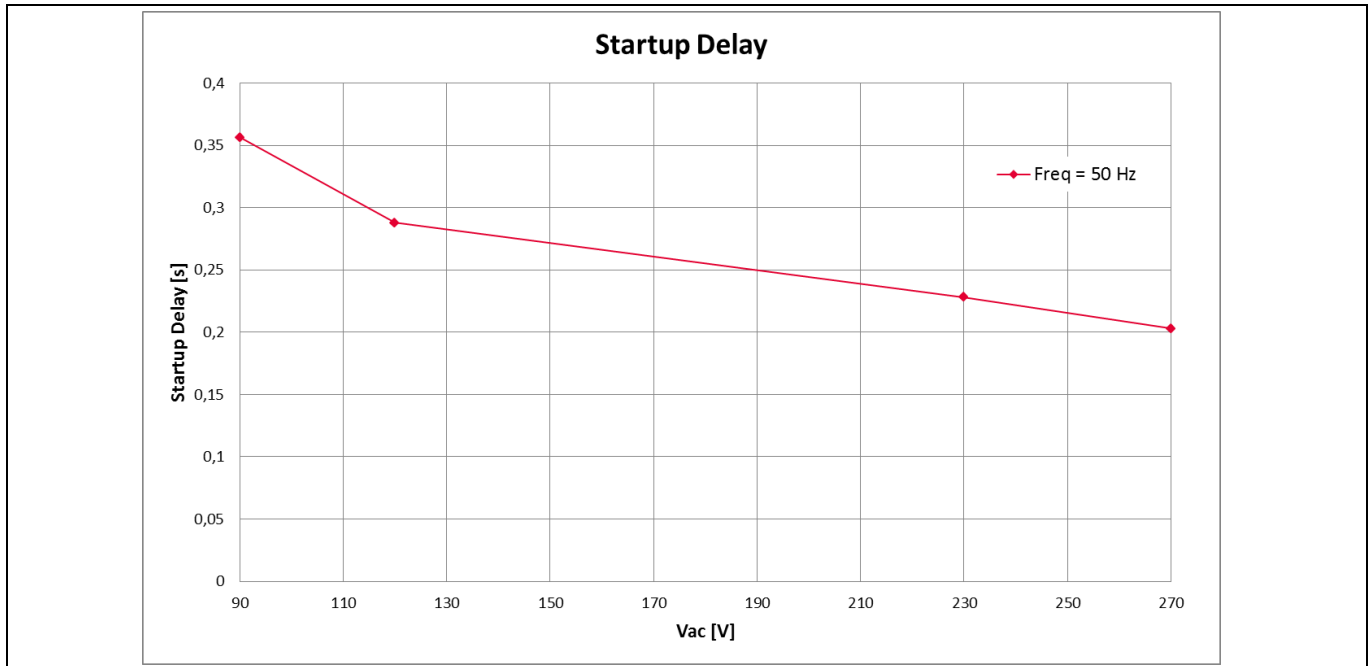

Figure 16 XDPL8221 100 W Reference board time-to-light

6.6 Standby power consumption

The standby power consumption is measured including CDM10VD and bleeder.

Table 8 Standby Power

Input	Dim-to-off	Output open
120 VAC	95 mW	203 mW
230 VAC	138 mW	232 mW
277 VAC	173 mW	310 mW

6.7 EMI Performance

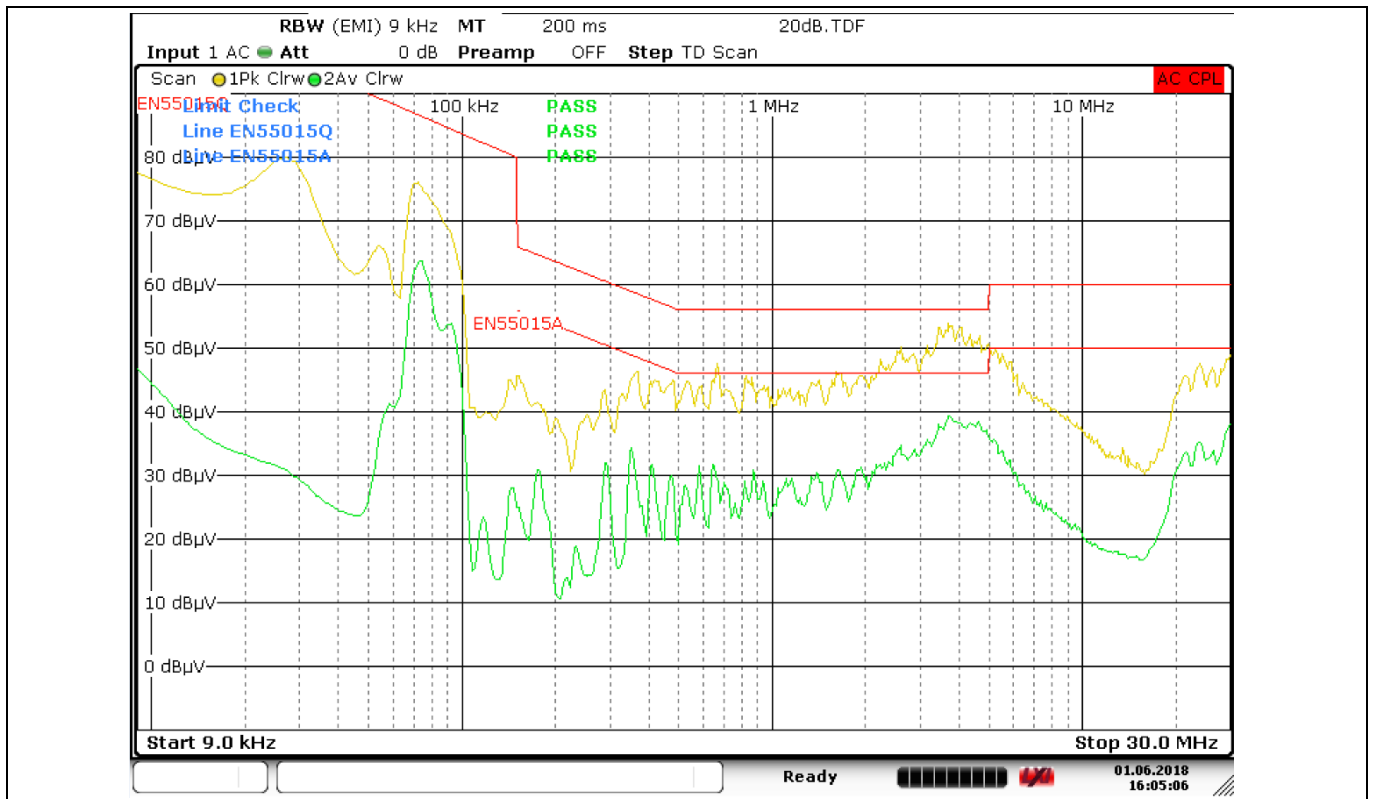

Figure 17 EMI Measurement @ 230 VAC with full load

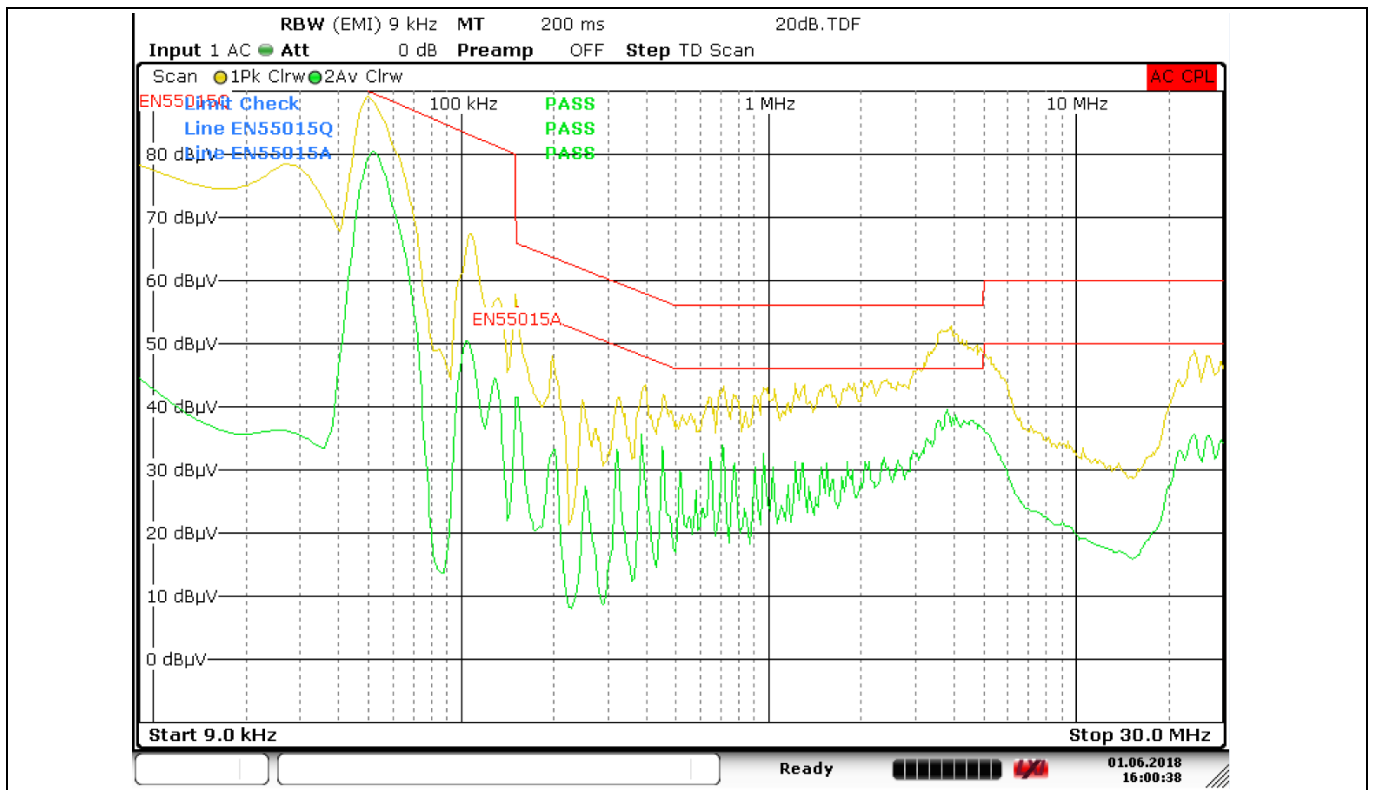

Figure 18 EMI Measurement @ 110 VAC with full load

7 Bill of Materials

Table 9 XDPL8221 100 W Reference board bill of materials

Quantity	Designator	Value	Description	Manufacturer	Manufacturer PartNumber
1	BR1	GBU4K-E3/45	4 Amp, 800V, SIP4	Diodes	GBU4K-E3/45
2	C1, C3	680p	Cap-1206-680p/630V/5%/U2J	muRata	GRM31A7U2J681JW31D
1	C10	0.1u	EMI Cap 100n/305V/X2/10%	TDK	B32922C3104K
2	C12, C13	0.22u	Metallized Polyester Film Capacitor	Panasonic	ECQE6224JF
3	C14, C15, C16	2200p/Y-Cap	Y-Cap 2200pF/250V/pitch 10	Murata	DE1E3KX222MA5B
1	C20	22n	MKT, 22nF/630V/±10%, 15mm, 4x12.5mm	Vishay	BFC237261223
1	C21	3.3n	GCM-Series General Purpose Monolithic Ceramic Capacitor for Automotive	muRata	GCM188R71H332KA37#
1	C22	47u	Miniature Aluminium Electrolytic Capacitor	Rubycon	500BXC47MEFC18X31.5
3	C23, C25, C26	1n	GCM-Series General Purpose Monolithic Ceramic Capacitor for Automotive	muRata	GCM1885C1H102JA16#
2	C24, C42	100p	GRM-Series General Purpose Monolithic Ceramic Capacitor	muRata	GRM1885C1H101JA01#
1	C31	2200p	Cap-1206-2200p/630V/10%/X7R	muRata	GRM31BR72J222KW01L
1	C32	330p	GRM-Series General Purpose Monolithic Ceramic Capacitor	muRata	GRM1885C1H331JA01#
2	C40, C200	100n	Cap-0603-100n/50V/0.1/X7R	AVX	06035C104K4Z2A
1	C43	0.10u	Cap-1210-100n/630V/10%/X7T	TDK	CGA6L1X7T2J104K160AC
1	C45	15u	Aluminum Electrolytic Capacitor, NHG Series, Type A, 15u, 50V, Pitch 2mm,	Panasonic	EEU-FC1H150
1	C47	47n	GCM-Series General Purpose Monolithic	muRata	GCM188R71H473KA55#

XDPL8221 100W Reference Board Engineering Report

XDPTM Digital Power



Bill of Materials

Quantity	Designator	Value	Description	Manufacturer	Manufacturer PartNumber
			Ceramic Capacitor for Automotive		
1	C48	68u	Aluminum Electrolytic Capacitor, UHE series	Nichicon	UHE2A680MPD1TD
1	C49	10u	Cap-1206-10u/50V/10%/X5R	muRata	GRM31CR61H106KA12 #
2	C101, C104	100n	Cap-1206-100n/100V/0.1/X7R	TDK	C3216X7R2A104K160A A
2	C102, C103	33u	Al-Cap 33uF/63V/pitch 3.5/DxH8,00x12.00mm	NICHICON	RNU1J330MDN1KX
1	C105	1n	Cap-1206-1n/630V/0.5/NPO	TDK	CGA5F4C0G2J102J085 AA
1	C106	680n	Cap-0603-680n/50V/0.1/X5R	TDK	C1608X5R1H684K080A B
1	C201	1u	Multilayer Ceramic Chip Capacitor, C Series, Commercial Grade, General	TDK	C1608X7R1E105K080A B
1	C203	4.7u	Al Cap 4.7uF/50V/pitch 2mm	Panasonic	EEUFC1H4R7
1	CN10	691412120003 MB	7.92 mm Contact Pitch, Right Angle Header	Wuerth Electronics	691412120003MB
2	D10, D11	US1M-E3/61T	Surface Mount Ultrafast Rectifier 1.0A/1000V	Vishay General Semiconductor	
1	D20	MUR460	Ultrafast Switchmode Power Rectifier 4.0 A/600 Vrrm	ON Semiconductor	MUR460G
8	D21, D22, D23, D40, D42, D43, D44, D200	LL4148	Small Signal Diode / 100V	Fairchild Semiconductor	LL4148
2	D24, D25	120V	Zener Voltage Regulators / 120V	ON Semiconductor	1SMB5951BT3
1	D30	US1K-E3/61T	Ultrafast Diode 800V/1.0A/DO-214AC	Vishay General Semiconductor	US1K-E3/61T
2	D51, D52	PESD12VS1UB	Unidirectional ESD Protection Diode / 12V	NXP Semiconductors	PESD12VS1UB

XDPL8221 100W Reference Board Engineering Report

XDPTM Digital Power



Bill of Materials

Quantity	Designator	Value	Description	Manufacturer	Manufacturer PartNumber
1	D100	STTH20L03CT	Dual Diode, TO220AB, 100V, CC	ST	STTH20L03CT
2	D101, D102	BAV19W	Diode 100V, 400mA, SOD123	Diodes Inc.	BAV19W
1	D202	PMEG3002EJ	Schottky Diode / 30V, 200mA, SOD323	NXP Semiconductors	PMEG3002EJ
1	F1	2A	Radial Lead Fuse Rectangular - Slow Blow, 2A, 250V	Multicomp	MST 2A 250V
3	HS_D100, HS_Q20, HS_Q30	577002B00000G	Slim Low Cost Channel Style Heat Sink	Aavid Thermalloy	577002B00000G
1	IC1	XDPL8221	LED Combo Control IC for PFC and FB Conversion	Infineon Technologies	XDPL8221
1	IC4	TCLT110	Optocoupler, Phototransistor Output, CTR 100% - 200% at 10mA, (Operating Temp -55°C - 100°C)	Vishay	TCLT1103
1	IC201	CDM10VD	Dimming Interface IC SOT-23-6	Infineon Technologies	CDM10VD-3
2	J51, J100	0R	0R/50V	Bourns	CR0603-J/-000ELF
1	L10	1mH	WE-CMB Common Mode Power Line Choke, Type XS, 1mH	'Wurth Elektronik	'744821201
1	L10A	100mH	WE-FCL Common Mode Power Line Choke, size ET35, 100/100mH, 1.25A	Wurth Elektronik	744866104
2	L11, L11a	220uH	IND 220uH, 1.6ARMS, 0R26, pitch 5mm, 13 x 10 x 15mm	Wuerth	7447480221
1	L100	47uH	Tor-Choke 47uH/ 3.6A/15%, Vertical	BOURNS JW MILLER	2109-V-RC
1	NTC10	10R	10R/265V/20%	Epcos	B57235S0100M0
1	NTC50	NTC47k	NTC47k/5%/0805	Epcos	B57471V2473J062

XDPL8221 100W Reference Board Engineering Report

XDPTM Digital Power



Bill of Materials

Quantity	Designator	Value	Description	Manufacturer	Manufacturer PartNumber
1	PCB	PCB	PCB, 205x50mm ² , 2Layer, 35um, FR4, 1.55mm Standard, Soldermask green both sides, Silkscreen white both sides		
1	Q20	IPA60R190C6	CoolMos C6, 650V, 0.190hm, TO220FP	Infineon Technologies	IPA60R190C6
1	Q30	IPA80R450P7	CoolMos P7, 800V, 0.450hm, TO220FP	Infineon Technologies	IPA80R450P7
1	Q41	BSS169	MOSFET N-Ch, 100V, 90mA, 120hm, SOT23	Infineon Technologies	BSS169
2	Q100, Q101	2N7002	OptiMOS Transistor 60V, 30hm, 300mA, SOT23	Infineon Technologies	2N7002
2	R12, R12a	39R	39R/200V/1%	TE CONNECTIVITY	352039RJT
5	R14, R15, R16, R103, R104	20k	20k/200V/1%	Vishay	CRCW120620K0FKEA
3	R20, R30, R37	10R	10R/200V/1%	Vishay	CRCW120610R0FKEA
3	R21, R24, R31	33k	33k/200V/1%	Vishay	CRCW120633K0FKEA
2	R22, R23	0R33	0.33/675mV/1%	Bourns	CRM1206-FX-R330 E LF
1	R25	4.7K	4.7k/200V/1%	Vishay	CRCW12064K70FKEA
3	R26, R27, R28	3.32M	3.32M/200V/1%	Vishay	CRCW12063M32FKEA
1	R29	52.3k	52.3k/150V/1%	Panasonic	ERJP06F5232V
3	R32, R33, R38	1R0	1.0R/200V/1%	Vishay	CRCW12061R00FKEA
1	R36	470R	470R/200V/1%	Vishay	CRCW1206470RFKEA
1	R40	68k	68k/150V/1%	Vishay	CRCW080568K0FKEA
1	R41	3.9k	3.9k/75V/1%	Vishay	CRCW06033K90FKEA
2	R42, R43	2.2R	2.2R/150V/1%	Vishay	CRCW08052R20FKEA
1	R46	39k	39k/150V/1%	Vishay	CRCW080539K0FKEA
1	R47	1.0R	1.0R/150V/1%	Vishay	CRCW08051R00FKEA
1	R50	1.0M	1.0M/150V/1%	Vishay	CRCW08051M00FKEA
1	R62	300k	300k/75V/1%	Vishay	CRCW0603300KFKEA
1	R101	10k	10k/500V/1%	Vishay	CRCW251210K0FKEG
2	R102, R102a	100k	100k/200V/1%	Vishay	CRCW1206100KFKEA
1	R105	1M	1M/75V/1%	Yageo/Phycomp	RC0603FR-071ML
1	R203	1R	1R/75V/1%	Vishay	CRCW06031R00FKED
1	R204	10k	10k/75V/1%	Yageo/Phycomp	RC0603FR-0710KL

Bill of Materials

Quantity	Designator	Value	Description	Manufacturer	Manufacturer PartNumber
1	T2	600uH	ERL35-14pin 1600uH, 1.16A, N87, Gab 0.4mm	Wuerth Electronics	750343236 Rev00
1	T3	1.0mH	ERL35, 14pin, N87, 1000uH, 3.2A	Wuerth Electronics	750317672 Rev00
1	VR10	S10K385E2K1	S10K385E2K1/385V/10%	Epcos	B72210S0381K101
1	X30	HTSW-103-07-G-S	Through hole .025" SQ Post Header, 2.54mm pitch, 3 pin, vertical, single row	Samtec	HTSW-103-07-G-S
2	X101, X202	691412120002 MB	Through-hole Shrouded Header, Top Entry, Vertical, 2.5mm Pitch, 2 Pins, Single Row, White	Wuerth Electronics	691412120002MB
1	ZD20	BZX384-C2V7	Zener Diode / 2.7V/SOD-323	NXP	BZX384-C2V7
1	ZD41	BZX384-C13	Zener Diode / 13V/SOD-323	NXP	BZX384-C13
1	ZD100	BZG03C62TR3	Zener Diode / 62V/ SMA	Vishay	BZG03C62TR3
2	ZD101, ZD102	BZX384-C12	Zener Diode / 12V/SOD-323	NXP	BZX384-C12
0	AC_L, AC_N, DIMMING, FB_AUX, FB_CS, FB_Drain, FB_ZCD, GND, HV_BUS, IC_GND, PFC_CS, PFC_Drain, PFC_GD, PFC_ZCD, SEC_AUX, SEC_AUX_GND, SEC_GND, SEC_LED+, SEC_MAIN*, SPD, TEMP, UART, Vcc	TP SMD	Testpad Not Assembled		
0	C2	NA	Cap-1206-470p/630V/5%/C0G	TDK	C3216C0G2J471J085A A

XDPL8221 100W Reference Board Engineering Report

XDP™ Digital Power



Bill of Materials

Quantity	Designator	Value	Description	Manufacturer	Manufacturer PartNumber
0	C100, C107	NA	Cap-1206-1n/100V/0.1/X7R	AVX	12061C102KAT2A
0	D201	NA	Small Signal Diode / 100V	Fairchild Semiconductor	LL4148
0	FB_GD	TP SMD	Testpad Not Assembled		
0	IC5, IC6	NA	Optocoupler, Phototransistor Output, CTR 100% - 200% at 10mA, (Operating Temp -55°C - 100°C)	Vishay	TCLT1103
0	J50, J55, J201	NA	0R/50V	Bourns	CR0603-J/-000ELF
0	J52	0R	0R/50V	Bourns	CR0603-J/-000ELF
0	L10B	NA	Power Line Choke	Epcos	
0	Q51	NA	NPN Silicon AF Transistor	NEXPERIA	BC847C,215
0	Q102, Q103	NA	OptiMOS Transistor 60V, 30hm, 300mA,SOT23	Infineon Technologies	2N7002
0	R10, R11	NA	510K/350V/5%	Welwyn Components Limited	MFP1-510KJI
0	R17, R18	NA	1M/200V/1%	Yageo/Phycomp	RC1206FR-071M0L
0	R34, R35	680k	680k/200V/1%	Vishay	CRCW1206680KFKEA
0	R51, R52, R53, R205, R206, R207	NA	10k/75V/1%	Yageo/Phycomp	RC0603FR-0710KL
0	R100, R106	NA	47R/200V/1%	Yageo/Phycomp	RC1206FR-0747RL
0	R107, R108	NA	100k/150V/1%	Vishay	CRCW0805100KFKEA
0	UART_SEC	NA	Through hole .025" SQ Post Header, Hi-Temp Strip, 2.54mm pitch, 4 pin, vertical, single row	Samtec	HTSW-104-07-G-S
0	X21	NA	Through hole .025" SQ Post Header, 2.54mm pitch, 2 pin, vertical, single row	Samtec	TSW-102-07-L-S
0	ZD103	NA	Zener Diode / 24V/SOD-323	NXP	BZX384-C12

7.1 Transformer specification

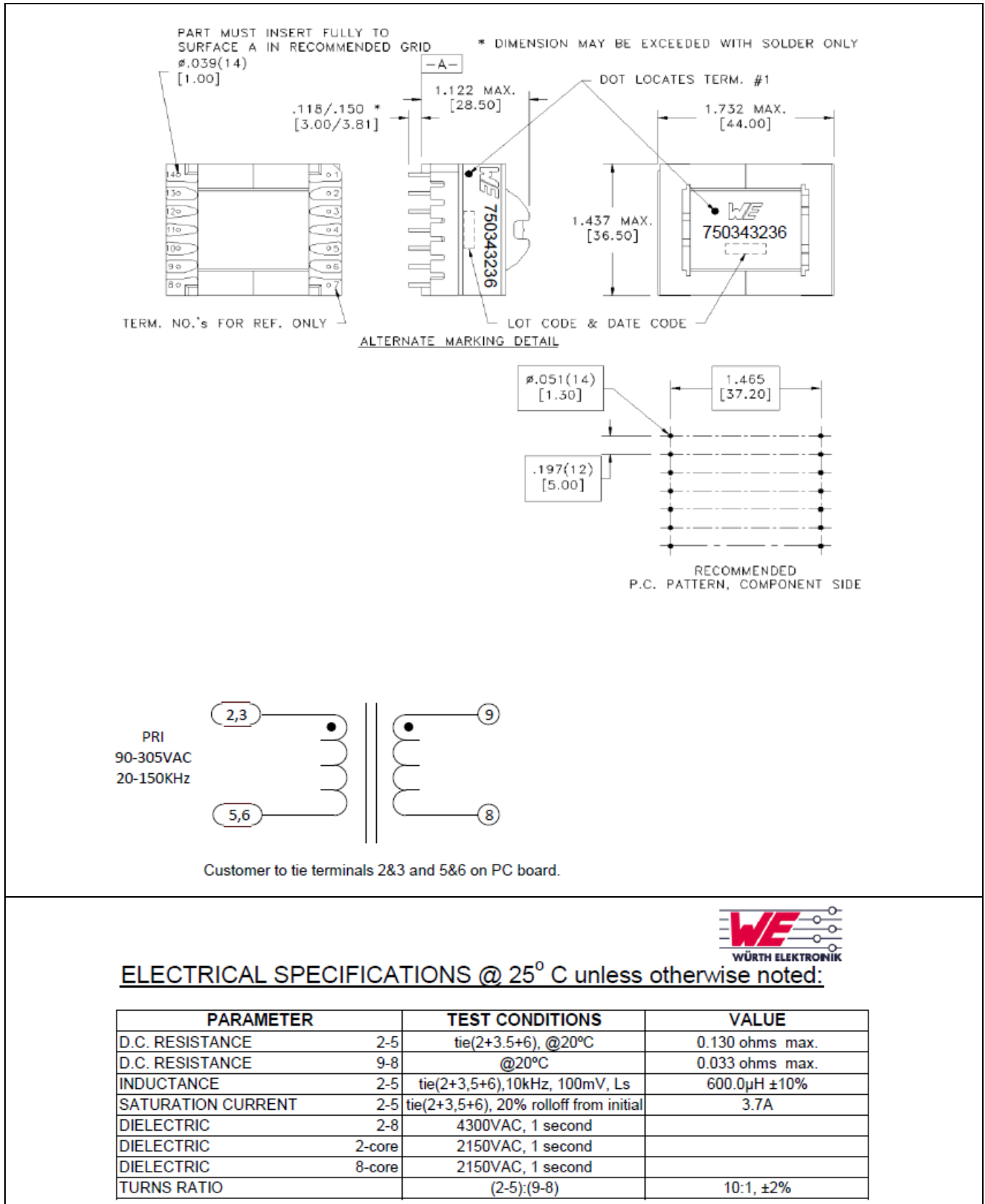
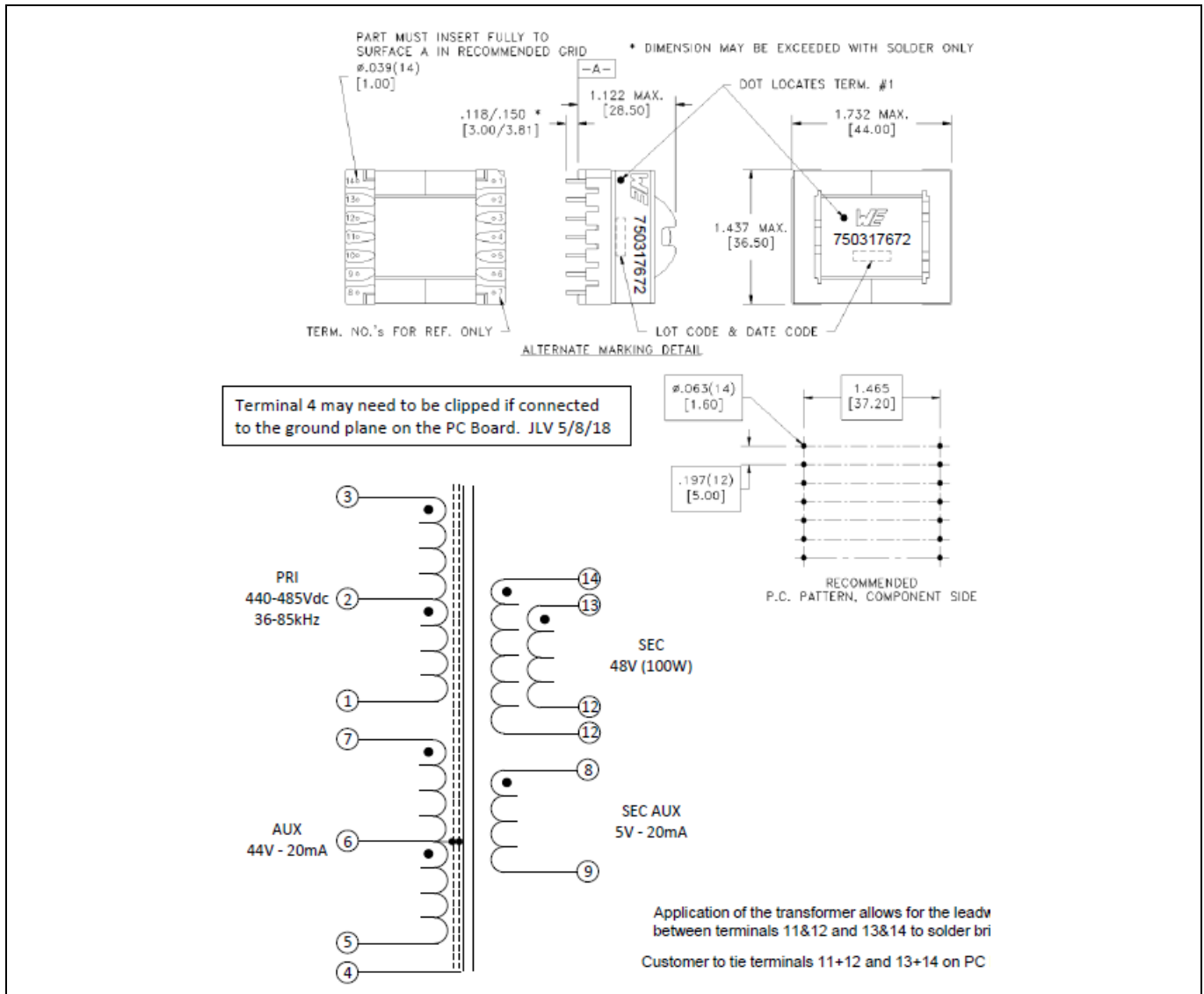

Figure 19 Würth Elektronik PFC choke 750343236 rev00 specification



ELECTRICAL SPECIFICATIONS @ 25° C unless otherwise noted:

PARAMETER	TEST CONDITIONS	VALUE
D.C. RESISTANCE	3-1 @20°C	0.815 ohms ±10%
D.C. RESISTANCE	5-6 @20°C	0.040 ohms ±20%
D.C. RESISTANCE	6-7 @20°C	0.205 ohms ±10%
D.C. RESISTANCE	8-9 @20°C	0.092 ohms ±10%
D.C. RESISTANCE	12-14 tie(13+14), @20°C	0.067 ohms ±10%
INDUCTANCE	3-1 10kHz, 100mV, Ls	1.00mH ±10%
SATURATION CURRENT	3-1 20% rolloff from initial	3.25A
LEAKAGE INDUCTANCE	3-1 tie(5+7, 8+9, 12+13+14), 100kHz, 100mV, Ls	15µH typ., 30µH max.
DIELECTRIC	1-14 tie(3+5, 9+12), 5900VAC, 1 second	4720VAC, 1 minute
DIELECTRIC	1-7 625VAC, 1 second	
DIELECTRIC	8-14 625VAC, 1 second	
URNS RATIO	(3-2):(2-1)	1:1, ±1%
URNS RATIO	(3-1):(14-12), tie(13+14)	3.23:1, ±1%
URNS RATIO	(3-1):(7-6)	4:1, ±1%
URNS RATIO	(3-1):(6-5)	28:1, ±1%
URNS RATIO	(3-1):(8-9)	28:1, ±1%

Figure 20 Würth Elektronik flyback transformer 750317672 rev00 specification

Revision history

Revision history

Document version	Date of release	Description of changes
1.0	2018-10-23	First release
1.1	2019-12-03	Correction of some values and formats

Trademarks

All referenced product or service names and trademarks are the property of their respective owners.

Edition 2019-12-03

Published by

Infineon Technologies AG

81726 Munich, Germany

© 2020 Infineon Technologies AG.

All Rights Reserved.

Do you have a question about this document?

Email: erratum@infineon.com

Document reference

QG_201711_PL39_005

IMPORTANT NOTICE

The information contained in this application note is given as a hint for the implementation of the product only and shall in no event be regarded as a description or warranty of a certain functionality, condition or quality of the product. Before implementation of the product, the recipient of this application note must verify any function and other technical information given herein in the real application. Infineon Technologies hereby disclaims any and all warranties and liabilities of any kind (including without limitation warranties of non-infringement of intellectual property rights of any third party) with respect to any and all information given in this application note.

The data contained in this document is exclusively intended for technically trained staff. It is the responsibility of customer's technical departments to evaluate the suitability of the product for the intended application and the completeness of the product information given in this document with respect to such application.

For further information on the product, technology, delivery terms and conditions and prices please contact your nearest Infineon Technologies office (www.infineon.com).

WARNINGS

Due to technical requirements products may contain dangerous substances. For information on the types in question please contact your nearest Infineon Technologies office.

Except as otherwise explicitly approved by Infineon Technologies in a written document signed by authorized representatives of Infineon Technologies, Infineon Technologies' products may not be used in any applications where a failure of the product or any consequences of the use thereof can reasonably be expected to result in personal injury.

单击下面可查看定价，库存，交付和生命周期等信息

[>>Infineon\(英飞凌\)](#)